

TOSHIBA

Industrial Inverter (For 3-phase induction motors)

Instruction Manual

TOSVERT™ VF-MB1

1-phase 240V class 0.2 to 2.2kW
3-phase 500V class 0.4 to 15kW

NOTICE

1. Make sure that this instruction manual is delivered to the end user of the inverter unit.
2. Read this manual before installing or operating the inverter unit, and store it in a safe place for reference.



E6581697

Safety precautions	<i>I</i>
Introduction	<i>II</i>
Contents	
Read first	<i>1</i>
Connection	<i>2</i>
Operations	<i>3</i>
Setting parameters	<i>4</i>
Main parameters	<i>5</i>
Other parameters	<i>6</i>
Operation with external signal	<i>7</i>
Monitoring the operation status	<i>8</i>
Measures to satisfy the standards	<i>9</i>
Peripheral devices	<i>10</i>
Table of parameters and data	<i>11</i>
Specifications	<i>12</i>
Before making a service call	<i>13</i>
Inspection and maintenance	<i>14</i>
Warranty	<i>15</i>
Disposal of the inverter	<i>16</i>

I. Safety precautions

The items described in these instructions and on the inverter itself are very important so that you can use the inverter safely, prevent injury to yourself and other people around you as well as to prevent damage to property in the area. Thoroughly familiarize yourself with the symbols and indications shown below and then continue to read the manual. Make sure that you observe all warnings given.



Explanation of markings

Marking	Meaning of marking
 Warning	Indicates that errors in operation may lead to death or serious injury.
 Caution	Indicates that errors in operation may lead to injury (*1) to people or that these errors may cause damage to physical property. (*2)

(*1) Such things as injury, burns or shock that will not require hospitalization or long periods of outpatient treatment.

(*2) Physical property damage refers to wide-ranging damage to assets and materials.

Meanings of symbols

Marking	Meaning of marking
	Indicates prohibition (Don't do it). What is prohibited will be described in or near the symbol in either text or picture form.
	Indicates an instruction that must be followed. Detailed instructions are described in illustrations and text in or near the symbol.
	-Indicates warning. What is warned will be described in or near the symbol in either text or picture form. -Indicates caution. What the caution should be applied to will be described in or near the symbol in either text or picture form.

■ Limits in purpose

This inverter is used for controlling speeds of three-phase induction motors in general industrial use.







Output by the inverter is as 3-phase output and cannot drive a single-phase motor.





Safety precautions



- ▼ The inverter cannot be used in any device that would present danger to the human body or from which malfunction or error in operation would present a direct threat to human life (nuclear power control device, aviation and space flight control device, traffic device, life support or operation system, safety device, etc.). If the inverter is to be used for any special purpose, first get in touch with the supplier.
- ▼ This product was manufactured under the strictest quality controls but if it is to be used in critical equipment, for example, equipment in which errors in malfunctioning signal output system would cause a major accident, safety devices must be installed on the equipment.
- ▼ Do not use the inverter for loads other than those of properly applied three-phase induction motors in general industrial use. (Use in other than properly applied three-phase induction motors may cause an accident.)



■ Handling

 Warning		Reference section
 Disassembly prohibited	<ul style="list-style-type: none"> Never disassemble, modify or repair. This can result in electric shock, fire and injury. For repairs, call your sales distributor. 	2.
 Prohibited	<ul style="list-style-type: none"> Do not open the terminal block cover while the inverter is on. The unit contains many high voltage parts and contact with them will result in electric shock. Do not stick your fingers into openings such as cable wiring holes and cooling fan covers. This can result in electric shock or other injury. Do not place or insert any kind of object into the inverter (electrical wire cuttings, rods, wires etc.). This can result in electric shock or fire. Do not allow water or any other fluid to come in contact with the inverter. This can result in electric shock or fire. 	2.1 2. 2. 2.
 Mandatory action	<ul style="list-style-type: none"> After replacing the terminal block cover, turn the input power on. Turning on the input power without replacing the terminal block cover may lead to electric shock. If the inverter begins to emit smoke or an unusual odor, or unusual sounds, immediately turn power off. If the equipment is continued in operation in such a state, the result may be fire. Call your local sales agency for repairs. Always turn power off if the inverter is not used for long periods of time since there is a possibility of malfunction caused by leaks, dust and other material. If power is left on with the inverter in that state, it may result in fire. 	2.1 3. 3.
 Caution		Reference section
 Contact prohibited	<ul style="list-style-type: none"> Do not touch heat radiating fins or discharge resistors. These devices are hot, and you'll get burned if you touch them. 	3.
 Mandatory action	<ul style="list-style-type: none"> Use an inverter that conforms to the specifications of power supply and three-phase induction motor being used. If the inverter being used does not conform to those specifications, not only will the three-phase induction motor not rotate correctly, it may also cause serious accidents through overheating and fire. 	1.1



■ Transportation & installation



 Warning		Reference section
 Prohibited	<ul style="list-style-type: none"> Do not install or operate the inverter if it is damaged or any component is missing. This can result in electric shock or fire. Call your local sales agency for repairs. 	1.4.4
	<ul style="list-style-type: none"> Do not place any inflammable objects nearby. If a flame is emitted due to malfunction, it may result in a fire. 	1.4.4
	<ul style="list-style-type: none"> Do not install in any location where the inverter could come into contact with water or other fluids. This can result in electric shock or fire. 	1.4.4



 Warning		Reference section
 Mandatory action	<ul style="list-style-type: none"> Must be used in the environmental conditions prescribed in the instruction manual. Use under any other conditions may result in malfunction. 	1.4.4
	<ul style="list-style-type: none"> Mount the inverter on a metal plate. 	1.4.4
	<ul style="list-style-type: none"> The rear panel gets very hot. Do not install in an inflammable object, this can result in fire. 	1.4.4
	<ul style="list-style-type: none"> Do not use the inverter without the terminal block cover. This can result in electric shock. Failure to do so can lead to risk of electric shock and can result in death or serious injury. 	1.4.4
	<ul style="list-style-type: none"> An emergency stop device must be installed that fits with system specifications (e.g. shut off input power then engage mechanical brake). Operation cannot be stopped immediately by the inverter alone, thus risking an accident or injury. 	1.4.4
	<ul style="list-style-type: none"> All options used must be those specified by Toshiba. The use of any other option may result in an accident. 	1.4.4
	<ul style="list-style-type: none"> When using switchgear for the inverter, it must be installed in a cabinet. Failure to do so can lead to risk of electric shock and can result in death or serious injury. 	10



 Caution		Reference section
 Prohibited	<ul style="list-style-type: none"> When transporting or carrying, do not hold by the front panel covers. The covers may come off and the unit will drop out resulting in injury. 	2.
	<ul style="list-style-type: none"> Do not install in any area where the unit would be subject to large amounts of vibration. That could result in the unit falling, resulting in injury. 	1.4.4
 Mandatory action	<ul style="list-style-type: none"> When removing and installing the terminal cover with a screwdriver, be sure not to scratch your hand as this results in injury. 	1.3.2
	<ul style="list-style-type: none"> Pressing too hard on the screwdriver may scratch the inverter. 	1.3.2
	<ul style="list-style-type: none"> Always cut the power supply when removing the wiring cover. 	1.3.2
	<ul style="list-style-type: none"> After wiring is complete, be sure to replace the terminal cover. 	1.3.2
	<ul style="list-style-type: none"> The main unit must be installed on a base that can bear the unit's weight. If the unit is installed on a base that cannot withstand that weight, the unit may fall resulting in injury. 	1.4.4
	<ul style="list-style-type: none"> If braking is necessary (to hold motor shaft), install a mechanical brake. The brake on the inverter will not function as a mechanical hold, and if used for that purpose, injury may result. 	1.4.4

■ Wiring



 Warning		Reference section
 Prohibited	<ul style="list-style-type: none"> Do not connect input power to the output (motor side) terminals (U/T1,V/T2,W/T3). That will destroy the inverter and may result in fire. 	2.2
	<ul style="list-style-type: none"> Do not connect braking resistors to the DC terminals (across PA/+ - PC/-). That may cause a fire. 	2.2
	<ul style="list-style-type: none"> Within 15 minutes after turning off input power, do not touch wires of devices (MCCB) connected to the input side of the inverter. That could result in electric shock. 	2.2
	<ul style="list-style-type: none"> When supplying power from a wall socket, do not exceed the rated capacity of the socket. Otherwise, this may generate excessive heat which can start a fire. 	10.



 Warning		Reference section
 Mandatory action	<ul style="list-style-type: none"> Electrical installation work must be done by a qualified expert. Connection of input power by someone who does not have that expert knowledge may result in fire or electric shock. 	2.1
	<ul style="list-style-type: none"> Connect output terminals (motor side) correctly. If the phase sequence is incorrect, the motor will operate in reverse and that may result in injury. 	2.1
	<ul style="list-style-type: none"> Wiring must be done after installation. If wiring is done prior to installation that may result in injury or electric shock The following steps must be performed before wiring. <ol style="list-style-type: none"> Turn off all input power. Wait at least 15 minutes and check to make sure that the charge lamp is no longer lit. Use a tester that can measure DC voltage (800VDC or more), and check to make sure that the voltage to the DC main circuits (across PA/+ - PC/-) is 45V or less. If these steps are not properly performed, the wiring will cause electric shock. 	2.1
	<ul style="list-style-type: none"> Tighten the screws on the terminal board to specified torque. If the screws are not tightened to the specified torque, it may lead to fire. Check to make sure that the input power voltage is +10%, -15% of the rated power voltage written on the rating label ($\pm 10\%$ when the load is 100% in continuous operation). If the input power voltage is not +10%, -15% of the rated power voltage ($\pm 10\%$ when the load is 100% in continuous operation) this may result in fire. 	2.1 1.4.4
 Be Grounded	<ul style="list-style-type: none"> Ground must be connected securely. If the ground is not securely connected, it could lead to electric shock or fire. 	2.1 2.2 10.



 Caution		Reference section
 Prohibited	<ul style="list-style-type: none"> Do not attach equipment (such as noise filters or surge absorbers) that have built-in capacitors to the output (motor side) terminals. That could result in a fire. 	2.1

 Warning		Reference section
 Mandatory action	<ul style="list-style-type: none"> Configuring settings on the setup menu incorrectly may break the inverter or lead to malfunction. 	3.1



■ Operations

 Warning		Reference section
 Prohibited	<ul style="list-style-type: none"> Never touch the internal connector while the upper terminal cover of control panel is opened. There is a risk of shock because it carries a high voltage. 	1.3.2



 Warning		Reference section
 Prohibited	<ul style="list-style-type: none"> Do not touch inverter terminals when electrical power is going to the inverter even if the motor is stopped. Touching the inverter terminals while power is connected to it may result in electric shock. Do not touch switches when the hands are wet and do not try to clean the inverter with a damp cloth. Such practices may result in electric shock. Do not go near the motor in alarm-stop status when the retry function is selected. The motor may suddenly restart and that could result in injury. Take measures for safety, e.g. attaching a cover to the motor, against accidents when the motor unexpectedly restarts. 	3. 3. 3.
 Mandatory action	<ul style="list-style-type: none"> After replacing the terminal block cover, turn the input power on. When installed inside a cabinet and using with the front cover removed, always close the cabinet doors first and then turn power on. Turning on the power with the terminal block cover or cabinet doors open may result in electric shock. Make sure that operation signals are off before resetting the inverter after malfunction. If the inverter is reset before turning off the operating signal, the motor may restart suddenly causing injury. 	3. 3.

 Caution		Reference section
 Prohibited	<ul style="list-style-type: none"> Observe all permissible operating ranges of motors and mechanical equipment. (Refer to the motor's instruction manual.) Not observing these ranges may result in injury. Do not set the stall prevention level ($F \underline{5} \underline{0} \underline{1}$) extremely low. If the stall prevention level parameter ($F \underline{5} \underline{0} \underline{1}$) is set at or below the no-load current of the motor, the stall preventive function will be always active and increase the frequency when it judges that regenerative braking is taking place. Do not set the stall prevention level parameter ($F \underline{5} \underline{0} \underline{1}$) below 30% under normal use conditions. 	3. 6.16.2
 Mandatory action	<ul style="list-style-type: none"> Use an inverter that conforms to the specifications of power supply and three-phase induction motor being operated. If the inverter being used does not conform to those specifications, not only will the three-phase induction motor not rotate correctly, but it may cause serious accidents through overheating and fire. Current may leak through the inverter's input/output wires because of insufficient electrostatic capacity on the motor with bad effects on peripheral equipment. The leakage current's value is affected by the carrier frequency and the length of the input/output wires. Test and adopt the following remedies against leak current. 	1.4.1 1.4.3



■ When operation by using remote keypad is selected

 Warning		Reference section
 Mandatory action	<ul style="list-style-type: none"> Set the parameter Communication time-out time (<i>F803</i>), Communication time-out action (<i>F804</i>) and Disconnection detection of remote keypad (<i>F731</i>). If these are not properly set, the inverter can not be stopped immediately in breaking communication and this could result in injury and accidents. An emergency stop device and the interlock that fit with system specifications must be installed. If these are not properly installed, the inverter can not be stopped immediately and this could result in injury and accidents. 	6.19



■ When sequence for restart after a momentary failure is selected (inverter)

 Caution		Reference section
 Mandatory action	<ul style="list-style-type: none"> Stand clear of motors and mechanical equipment. If the motor stops due to a momentary power failure, the equipment will start suddenly after power recovers. This could result in unexpected injury. Attach warnings about sudden restart after a momentary power failure on inverters, motors and equipment for prevention of accidents in advance. 	6.12.1
		6.12.1



■ When retry function is selected (inverter)

 Caution		Reference section
 Mandatory action	<ul style="list-style-type: none"> Stand clear of motors and equipment. If the motor and equipment stop when the alarm is given, selection of the retry function will restart them suddenly after the specified time has elapsed. This could result in unexpected injury. Attach warnings about sudden restart in retry function on inverters, motors and equipment for prevention of accidents in advance. 	6.12.3
		6.12.3



■ Measures to satisfy the standards

 Caution		Reference section
 Mandatory action	<ul style="list-style-type: none"> For preventive maintenance, check at least once a year whether the Safe Torque Off safety function operates normally. 	9.3

■ Maintenance and inspection

 Warning		Reference section
 Prohibited	<ul style="list-style-type: none"> Do not replace parts. This could be a cause of electric shock, fire and bodily injury. To replace parts, call the local sales agency. 	14.2
 Mandatory action	<ul style="list-style-type: none"> The equipment must be inspected every day. If the equipment is not inspected and maintained, errors and malfunctions may not be discovered and that could result in accidents. Before inspection, perform the following steps. <ol style="list-style-type: none"> Turn off all input power to the inverter. Wait at least 15 minutes and check to make sure that the charge lamp is no longer lit. Use a tester that can measure DC voltages (400/800VDC or more), and check to make sure that the voltage to the DC main circuits (across PA/+ - PC/-) is 45V or less. If inspection is performed without performing these steps first, it could lead to electric shock. 	14. 14. 14.2

■ Disposal

 Caution		Reference section
 Mandatory action	<ul style="list-style-type: none"> If you dispose of the inverter, have it done by a specialist in industry waste disposal(*). If you dispose of the inverter in an inappropriate way, this can result in explosion of capacitor or produce noxious gases, resulting in injury. (*) Persons who specialize in the processing of waste and known as "industrial waste product collectors and transporters" or "industrial waste disposal persons. "If the collection, transport and disposal of industrial waste is done by someone who is not licensed for that job, it is a punishable violation of the law. (Laws in regard to cleaning and processing of waste materials) 	16.

■ Attach caution labels

Shown here are examples of warning labels to prevent, in advance, accidents in relation to inverters, motors and other equipment. Be sure to affix the caution label where it is easily visible when selecting the auto-restart function (6.12.1) or the retry function (6.12.3).

If the inverter has been programmed for restart sequence of momentary power failure, place warning labels in a place where they can be easily seen and read.
(Example of warning label)

 Caution (Functions programmed for restart)
Do not go near motors and equipment. Motors and equipment that have stopped temporarily after momentary power failure will restart suddenly after recovery.

If the retry function has been selected, place warning labels in a location where they can be easily seen and read.
(Example of warning label)

 Caution (Functions programmed for retry)
Do not go near motors and equipment. Motors and equipment that have stopped temporarily after an alarm will restart suddenly after the specified time has elapsed.

II. Introduction

Thank you for your purchase of the Toshiba "TOSVERT VF-MB1" industrial inverter.

This is the Ver. 100 CPU version inverter.
Please be informed that CPU version will be frequently upgraded.

— Contents —

I	Safety precautions	1
II	Introduction	8
1.	Read first	A-1
1.1	Check product purchase	A-1
1.2	Contents of the product	A-2
1.3	Names and functions	A-3
1.4	Notes on the application	A-15
2.	Connection	B-1
2.1	Cautions on wiring	B-1
2.2	Standard connections	B-3
2.3	Description of terminals	B-6
3.	Operations	C-1
3.1	How to Set the Setup Menu	C-2
3.2	Simplified Operation of the VF-MB1	C-4
3.3	How to operate the VF- MB1	C-9
3.4	Meter setting and adjustment	C-13
3.5	Setting the electronic thermal	C-17
3.6	Preset-speed operation (speeds in 15 steps)	C-25
4.	Setting parameters	D-1
4.1	Setting and Display Modes	D-1
4.2	How to set parameters	D-3
4.3	Functions useful in searching for a parameter or changing a parameter setting	D-7
4.4	Checking the region settings selection	D-13
4.5	EASY key function	D-14
5.	Main parameters	E-1
5.1	Searching for changes using the history function (<i>RUH</i>)	E-1
5.2	Setting a parameter using the guidance function (<i>RUF</i>)	E-2
5.3	Selecting inverter overload characteristic	E-4
5.4	Setting acceleration/deceleration time	E-5
5.5	Increasing starting torque	E-7
5.6	Selection of operation mode	E-10
5.7	Meter setting and adjustment	E-14
5.8	Forward/reverse run selection (Panel keypad)	E-14
5.9	Maximum frequency	E-15
5.10	Upper limit and lower limit frequencies	E-16

5.11	Base frequency	E-17
5.12	Selecting control mode.....	E-18
5.13	Manual torque boost - increasing torque boost at low speeds	E-25
5.14	Setting the electronic thermal.....	E-25
5.15	Preset-speed operation (speeds in 15 steps).....	E-25
5.16	Process input value of PID control	E-26
5.17	Standard default setting	E-26
5.18	Checking the region setting selection	E-26
5.19	Registered parameters display selection	E-26
5.20	Searching for and resetting changed parameters	E-26
6.	Other parameters	F-1
6.1	Input/output parameters	F-1
6.2	Input signal selection.....	F-4
6.3	Terminal function selection.....	F-7
6.4	Basic parameters 2	F-10
6.5	V/f 5-point setting	F-12
6.6	Frequency priority selection	F-12
6.7	Operation frequency.....	F-22
6.8	DC braking.....	F-24
6.9	Time limit for lower-limit frequency operation	F-26
6.10	Jog run mode	F-27
6.11	Jump frequency - avoiding resonant frequencies.....	F-29
6.12	Preset-speed frequencies	F-30
6.13	Bumpless operation	F-30
6.14	PWM carrier frequency	F-32
6.15	Trip-less intensification.....	F-35
6.16	Droop control.....	F-49
6.17	Light-load high-speed operation function	F-51
6.18	Braking function	F-51
6.19	Acceleration/deceleration suspend function.....	F-55
6.20	PID control	F-57
6.21	Setting motor constants.....	F-63
6.22	Torque limit.....	F-69
6.23	Acceleration/deceleration time 2 and 3	F-73
6.24	Protection functions.....	F-78
6.25	Forced fire-speed control function.....	F-91
6.26	Override	F-92
6.27	Analog input terminal function selection.....	F-95
6.28	Adjustment parameters	F-96
6.29	Operation panel parameter	F-99
6.30	Tracing functions.....	F-110
6.31	Integrating wattmeter	F-114
6.32	Parameter registration to easy setting mode.....	F-114

6.33	Communication function	F-115
6.34	Permanent magnet motors	F-123
6.35	Traverse function	F-124
6.36	Logic sequence function	F-124
7.	Operations with external signal	G-1
7.1	Operating external signals	G-1
7.2	Applied operations by an I/O signal (operation from the terminal block)	G-2
7.3	Speed instruction (analog signal) settings from external devices	G-13
8.	Monitoring the operation status	H-1
8.1	Flow of status monitor mode	H-1
8.2	Status monitor mode	H-2
8.3	Display of trip information	H-6
9.	Measures to satisfy the standards	I-1
9.1	How to cope with the CE directive	I-1
9.2	Compliance with UL Standard and CSA Standard	I-6
9.3	Compliance with Safety Standards	I-8
10.	Peripheral devices	J-1
10.1	Selection of wiring materials and devices	J-1
10.2	Installation of a magnetic contactor	J-3
10.3	Installation of an overload relay	J-4
10.4	Optional external devices	J-5
11.	Table of parameters and data	K-1
11.1	Frequency setting parameter	K-1
11.2	Basic parameters	K-1
11.3	Extended parameters	K-5
11.4	Default settings by inverter rating	K-30
11.5	Default settings by setup menu	K-30
11.6	Input Terminal Function	K-31
11.7	Output Terminal Function	K-35
12.	Specifications	L-1
12.1	Models and their standard specifications	L-1
12.2	Outside dimensions and mass	L-4
13.	Before making a service call - Trip information and remedies	M-1
13.1	Trip causes/warnings and remedies	M-1
13.2	Restoring the inverter from a trip	M-7
13.3	If the motor does not run while no trip message is displayed	M-8
13.4	How to determine the causes of other problems	M-9

14. Inspection and maintenance	N-1
14.1 Regular inspection	N-1
14.2 Periodical inspection	N-2
14.3 Making a call for servicing	N-5
14.4 Keeping the inverter in storage	N-5
15. Warranty.....	O-1
16. Disposal of the inverter	P-1

1. Read first

1.1 Check product purchase

Before using the product you have purchased, check to make sure that it is exactly what you ordered.

⚠ Caution



Mandatory action

Use an inverter that conforms to the specifications of power supply and three-phase induction motor being used. If the inverter being used does not conform to those specifications, not only will the three-phase induction motor not rotate correctly, it may also cause serious accidents through overheating and fire.

1

Rating label

Inverter main unit

Model
Power supply
Motor capacity

VF-MB1
1PH-200/240V-0.2kW/0.25HP

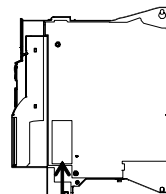

Name plate

Carton box

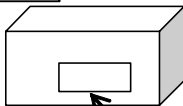

Type indication label

Setup sheet

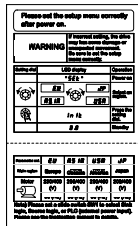

Rating label

Danger label

Danger label



Name plate

Inverter Type
Inverter rated output capacity
Power supply
Rated input current
Rated output current

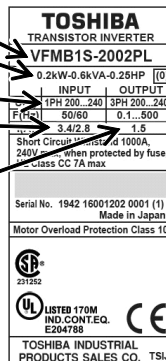

Instruction manual

Danger label kit

E6581697

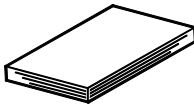

Danger labels for sticking in 6 languages.



1.2 Contents of the product

Explanation of the name plate label

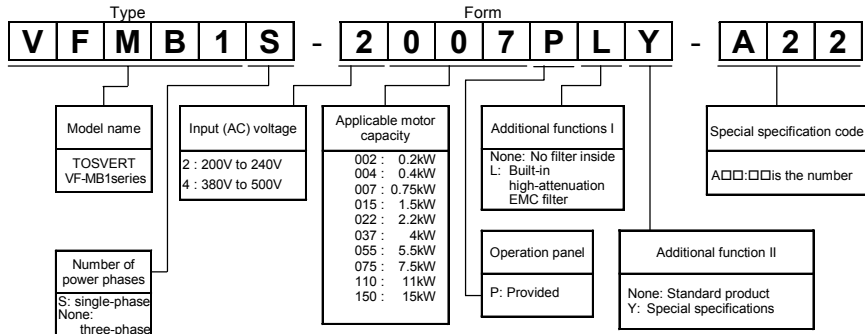

Warning: Always shut power off first then check the ratings label of inverter held in a cabinet.

1.3 Names and functions

1.3.1 Outside view

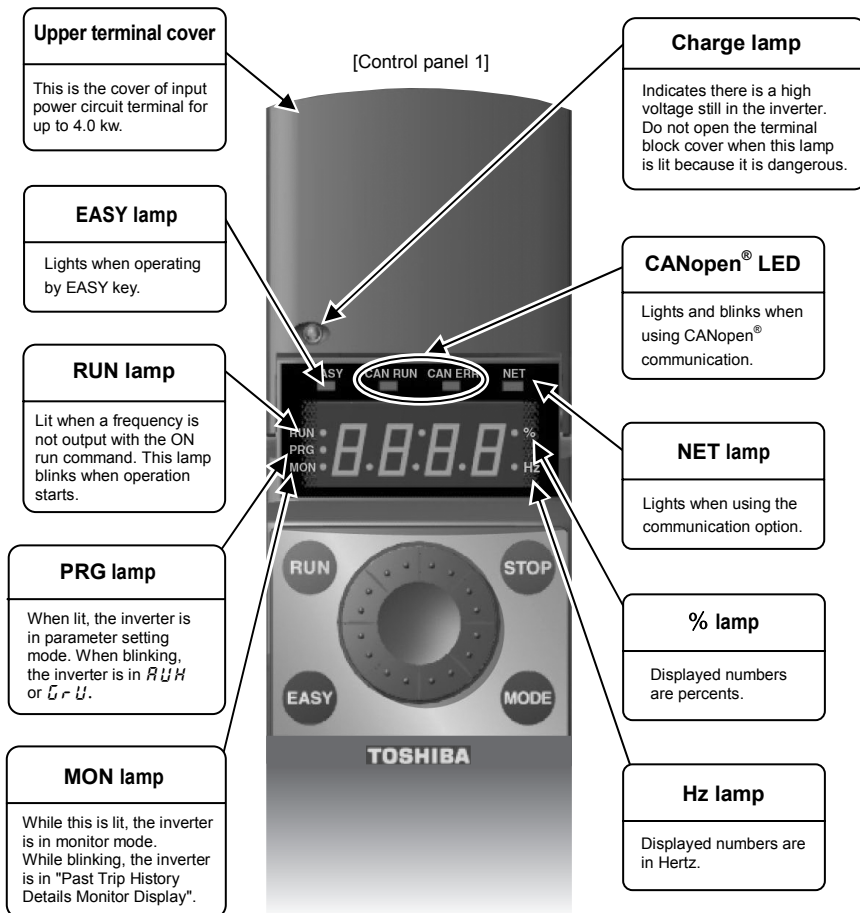

* CANopen is the registered trademark of CAN in Automation.

[Control panel 2]

1

RUN key

Pressing this key while the run lamp is on starts operation.

EASY key

Switches between easy and standard setting modes.

Setting dial

Turning the dial left and right changes the operation frequency, cycles parameters, and cycles among menus within parameters. Pressing the center of the setting dial is used for executing operations and determining values.

Control terminal cover

This is the control terminal board cover. Always close this cover before operation to avoid accidentally touching the terminal board.

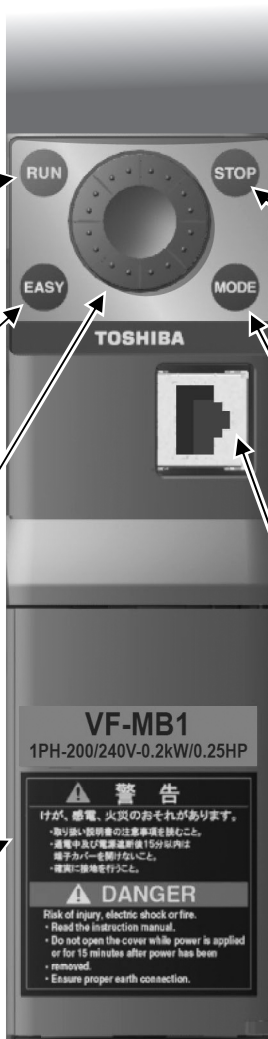
**STOP key**

While the running lamp is blinking, pressing this key slows down and stops the inverter.

MODE key

Switches between run, settings, and status monitor modes.

RS485 connector

RJ45 connector for using RS485/CANopen communication and other options

VF-MB1
1PH-200/240V-0.2kW/0.25HP

警告

けが、感電、火災のおそれがあります。
-取り扱い説明書の注意事項を熟読のこと。
-通電中及び電圧変動時15分以内は
端子カバーを閉鎖すること。
-確認に接地を行ってください。

DANGER

Risk of injury, electric shock or fire.
• Read the instruction manual.
• Do not open the cover while power is applied
or for 15 minutes after power has been
removed.
• Ensure proper earth connection.

[Opening the control terminal cover]

1)

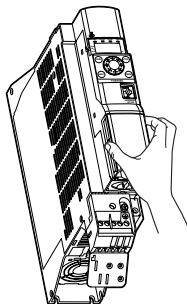

2)

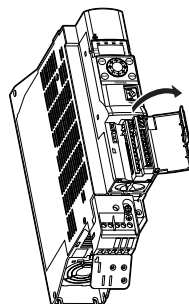

1

★About the monitor display

The LED on the operation panel uses the following symbols to indicate parameters and operations.

LED display (numbers)

0	1	2	3	4	5	6	7	8	9	-
<i>0</i>	<i>1</i>	<i>2</i>	<i>3</i>	<i>4</i>	<i>5</i>	<i>6</i>	<i>7</i>	<i>8</i>	<i>9</i>	<i>-</i>

LED display (letters)

Aa	Bb	C	c	Dd	Ee	Ff	Gg	H	h	I	i	Jj	Kk	Ll
<i>R</i>	<i>b</i>	<i>Ċ</i>	<i>c</i>	<i>d</i>	<i>E</i>	<i>F</i>	<i>G</i>	<i>H</i>	<i>h</i>	<i>I</i>	<i>i</i>	<i>J</i>	<i>K</i>	<i>L</i>
Mm	Nn	O	o	Pp	Qq	Rr	Ss	Tt	Uu	Vv	Ww	Xx	Yy	Zz
<i>m</i>	<i>n</i>	<i>O</i>	<i>o</i>	<i>P</i>	<i>q</i>	<i>r</i>	<i>S</i>	<i>t</i>	<i>U</i>	<i>v</i>	/	/	<i>y</i>	/

1.3.2 Opening terminal cover and terminal block

Warning



Prohibited

- Never touch the internal connector while the upper cover of control panel is opened. There is a risk of shock because it carries a high voltage.

Caution



Mandatory action

- When removing and mounting the terminal cover or the terminal block with a screwdriver, be sure not to scratch your hand as this results in injury.
- Pressing too hard on the screwdriver may scratch the inverter.
- Always cut the power supply when removing the wiring cover.
- After wiring is complete, be sure to replace the terminal cover.

Use the following procedure to open the terminal cover and pull the power terminal block.

(1) Opening the upper terminal (input terminal) cover (VFMB1S-2002 to 2022PL, VFMB1-4004 to 4037PL)

1)

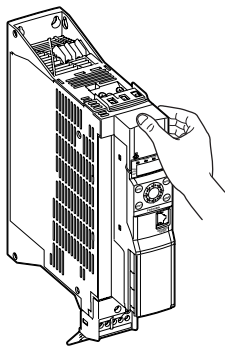

Put your finger on the terminal cover.

2)

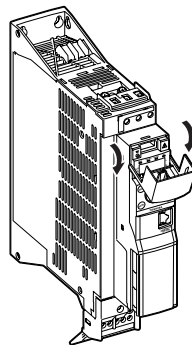

Pull the cover open rotating.

(2) Mounting lower power terminal (output terminal) block (VFMB1S-2002 to 2022PL, VFMB1-4004 to 4037PL)

1)

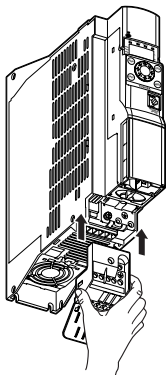

Put the terminal block on lower of inverter.

2)

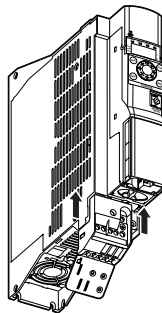

Slide the terminal block in upward.

3)

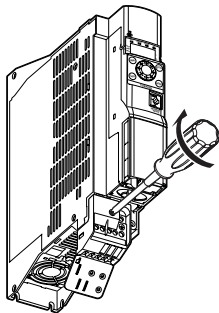

Insert the attached screw into the hole.
And tighten the screw by a screwdriver.
And then insert the attached earth screw into
the earth hole and tighten the earth screw by a
screwdriver.

1

(3) Removing lower power terminal (output terminal) block (VFMB1S-2002 to 2022PL, VFMB1-4004 to 4037PL)

1)

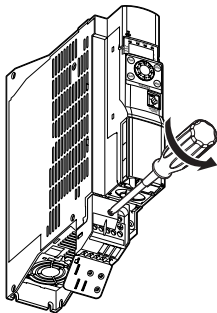

Loose the earth screw by a screwdriver.
Loose the screw by a screwdriver.
And pick the screw up.

2)

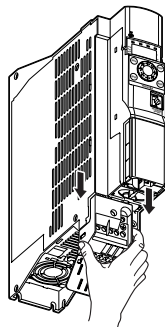

Move the terminal block downward.

3)

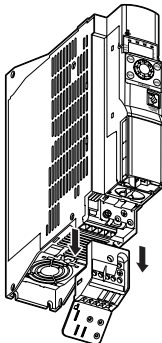

Slide the terminal block to remove it.

(4) Removing the power terminal cover (VFMB1-4055 to 4150PL)

1)

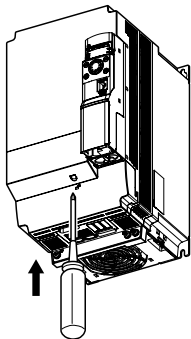

Insert a screwdriver or other thin object into the hole indicated with the □ mark.

2)

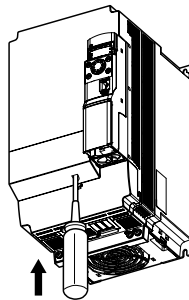

Press in on the screwdriver.

3)

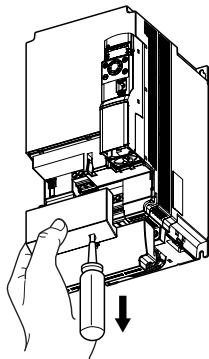

While pressing on the screwdriver, slide the terminal cover downward to remove it.

★ After wiring is complete, be sure to restore the terminal cover to its original position.

1.3.3 Power circuit and control circuit terminal boards

1) Power circuit terminal

In case of the lug connector, cover the lug connector with insulated tube, or use the insulated lug connector.

Use a plus or minus screwdriver to loose or tighten screws.

Models	VFMB1S-2002 to 2022PL VFMB1-4004 to 4037PL				VFMB1-4055 to 4150PL			
	Screw size	Torque		Strip length	Screw size	Torque		Strip length
Input	M3	0.6Nm	5.3lb • in	7-8mm	M4	1.4Nm	12.4lb • in	9-10mm
Output	M3	0.8Nm	7.1lb • in	9-10mm				
Earth (For input)	M5	3.0Nm	26.6lb • in	-	M5	3.0Nm	26.6lb • in	-
Earth (For output)	M4	1.4Nm	12.4lb • in	-				

Refer to section 2.3.1 for details about terminal functions.

VFMB1S-2002 to 2007PL

VFMB1S-2015, 2022PL

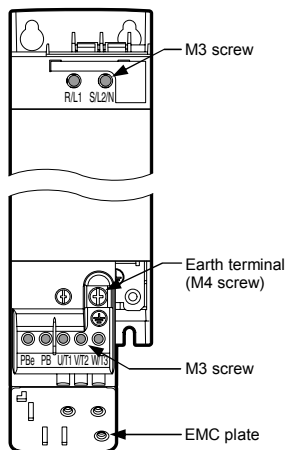
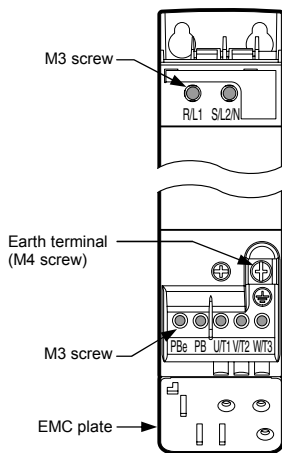

VFMB1-4004 to 4015PL

VFMB1-4022, 4037PL

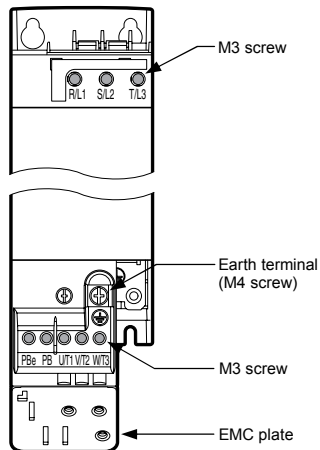
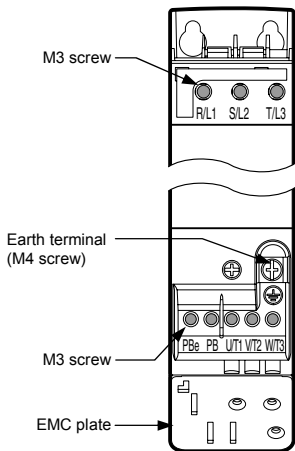

1

<Top view>

VFMB1S-2002 to 2022PL,
VFMB1-4004 to 4037PL

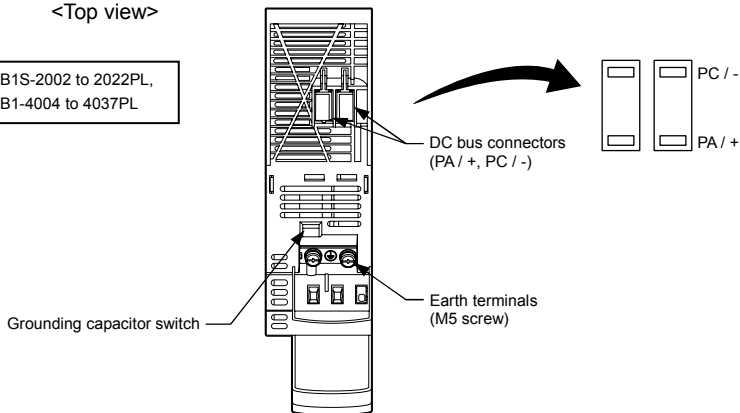

1

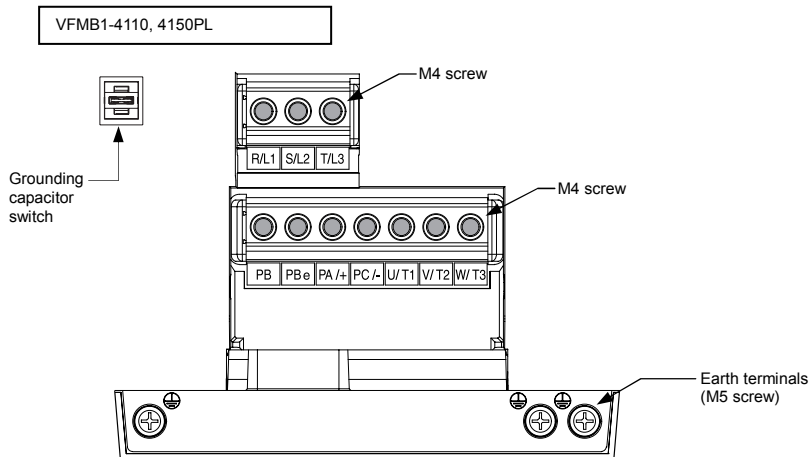
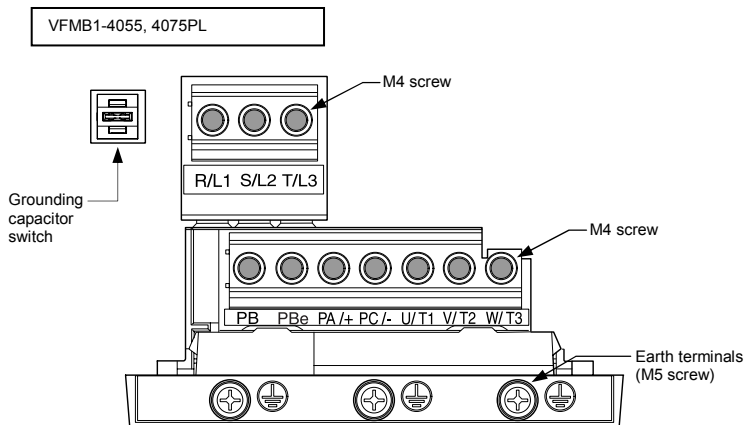

- Note1) Bend the clips on the wiring port of the terminal cover to connect the PB, PB_e, PA/+, and PC/- terminals.
- Note2) Be careful to insert all wires into the cage of terminal block.

2) Grounding capacitor switch

This inverter has a built-in high-attenuation noise filter and is grounded via a capacitor. A switch makes for easy switching to reduce leakage current from the inverter and the load on the capacitor. However, be careful, as reducing the load means non-conformity with the EMC standard on the inverter itself. Always do switching with the power off.

VFMB1S-2002 to 2022PL, VFMB1-4004 to 4037PL

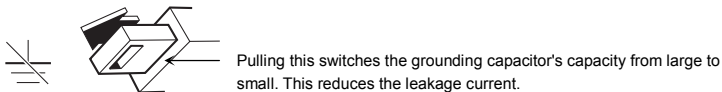
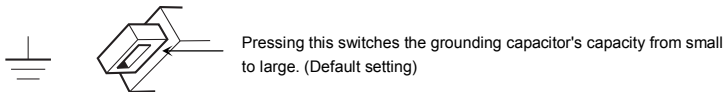

VFMB1-4055 to 4150PL

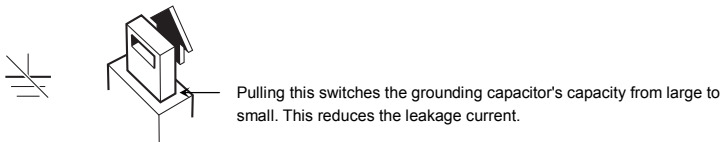
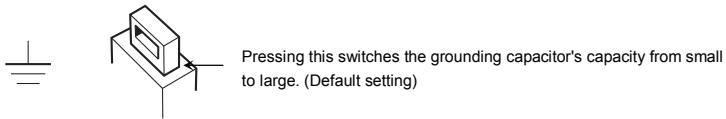

3) Control circuit terminal board

The control circuit terminal board is common to all equipment.

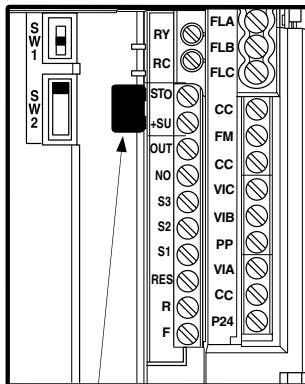
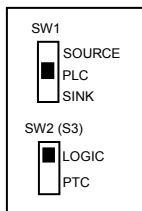

Screw size	Recommended tightening torque
M3 screw	0.5 N·m
	4.4 lb·in

Stripping length: 6 (mm)

Screwdriver: Small-sized flat-blade screwdriver
 (Blade thickness: 0.6 mm, blade width: 3.5 mm)

Shorting-bar

Refer to section 2.3.2 for details about all terminal functions.

Wire size

Conductor	1 wire	2 wires of same size
Solid	0.3-1.5mm ² (AWG 22-16)	0.3-0.75mm ² (AWG 22-18)
Stranded		

Recommended ferrule

Using ferrule to be improved efficiency and reliability of wiring is recommended.

Wire size mm ² (AWG)	Type	
	PHOENIX CONTACT	Dinkle International.,Ltd
0.34 (22)	AI 0.34-6TQ	DN00306
0.5 (20)	AI 0.5-6WH	DN00506
0.75 (18)	AI 0.75-6GY	DN00706
1 (18)	AI 1-6RD	DN01006
1.5 (16)	AI 1.5-8BK	DN01508
*2 2 X 0.5 (-)	AI TWIN2 X 0.5-8WH	DTE00508
*2 2 X 0.75 (-)	AI TWIN2 X 0.75-8GY	DTE00708



*1: Crimping pliers CRIMPFOX ZA3 (PHOENIX CONTACT), CT1 (Dinkle International., Ltd)

*2: These ferrules enable practical crimping of two wires in a ferrule.

1.4 Notes on the application

1.4.1 Motors

When this inverter and the motor are used in conjunction, pay attention to the following items.

 Caution	
 Mandatory action	Use an inverter that conforms to the specifications of power supply and three-phase induction motor being operated. If the inverter being used does not conform to those specifications, not only will the three-phase induction motor not rotate correctly, but it may cause serious accidents through overheating and fire.

Comparisons with commercial power operation

This inverter employs the sinusoidal PWM system. However, the output voltage and output current are not perfect sine waves, they have a distorted wave that is close to sinusoidal waveform. This is why compared to operation with a commercial power there will be a slight increase in motor temperature, noise and vibration.

Operation in the low-speed area

When running continuously at low speed in conjunction with a general purpose motor, there may be a decline in that motor's cooling effect. If this happens, operate with the output decreased from rated load. To carry out low-speed operation continuously at the rated torque, we recommend to use a inverter rated motor or a forced cooled motor designed for use with an inverter. When operating in conjunction with a inverter rated motor, you must change the inverter's motor overload protection level $\overline{C} \overline{L} \overline{P}$ to VF motor use.

Adjusting the overload protection level

This inverter protects against overloads with its overload detection circuits (electronic thermal). The electronic thermal's reference current is set to the inverter's rated current, so it must be adjusted in line with the rated current of the motor being used in combination.

High speed operation at and above 60Hz

Operating at frequencies greater than 60Hz will increase noise and vibration. There is also a possibility this will exceed the motor's mechanical strength limits and the bearing limits so you should inquire to the motor's manufacturer about such operation.

Method of lubricating load mechanisms

Operating an oil-lubricated reduction gear and gear motor in the low-speed areas will worsen the lubricating effect. Check with the manufacturer of the reduction gear to find out about operable gearing area.

Low loads and low inertia loads

The motor may demonstrate instability such as abnormal vibrations or overcurrent trips at light loads of 5% or under of the load percentage, or when the load's inertia moment is extremely small. If that happens reduce the carrier frequency.

Occurrence of instability

Unstable phenomena may occur with the load and motor combinations shown below.

- Combined with a motor that exceeds applicable motor ratings for the inverter
- Combine with a much smaller motor according to the applicable motor rating of the inverter.
- Combined with special motors

To deal with the above lower the settings of inverter carrier frequency.

- Combined with couplings between load devices and motors with high backlash

When using the inverter in the above combination, use the S-pattern acceleration/deceleration function, or when vector control is selected, adjust the speed control response or switch to V/f control mode.

- Combined with loads that have sharp fluctuations in rotation such as piston movements

In this case, adjust the response time (inertial moment setting) during vector control or switch to V/f control.

Braking a motor when cutting off power supply

A motor with its power cut off goes into free-run, and does not stop immediately. To stop the motor quickly as soon as the power is cut off install an auxiliary brake. There are different kinds of brake devices, both electrical and mechanical. Select the brake that is best for the system.

Load that produces regenerative torque

When combined with a load that produces regenerative torque, the overvoltage or overcurrent protection function may be activated to trip the inverter.

Motors with a brake

When motors with a brake are directly connected to the inverter's output, the brake cannot be released at startup because of low voltage. Wire the brake circuit separately from the main circuit.

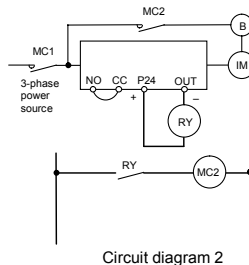
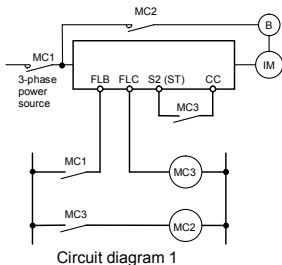

In circuit diagram 1, the brake is turned on and off through MC2 and MC3. If you do not wire it as shown in diagram 1, an over-current trip may occur because of a bound current during brake operation. (Example of running preparation ST assigned to terminal S2.)

In circuit diagram 2, the brake is turned on and off by using low-speed signal OUT.

In some situations, such as with elevators, turning the brake on and off with a low-speed signal may be appropriate. Be sure to contact us before designing your system.

Measures to protect motors against surge voltages

In a system in which a 500V-class inverter is used to control the operation of a motor, very high surge voltages may be produced. When applied to the motor coils repeatedly for a long time, may cause deterioration of their insulation, depending on the cable length, cable routing and types of cables used. Here are some examples of measures against surge voltages.

- (1) Lower the inverter's carrier frequency.
- (2) Set the parameter $F \text{ } \bar{3} \text{ } 1 \text{ } \bar{5}$ (Carrier frequency control mode selection) to 2 or 3.
- (3) Use a motor with high insulation strength.
- (4) Insert an AC reactor or a surge voltage suppression filter between the inverter and the motor.

1.4.2 Inverters

Protecting inverters from overcurrent

The inverter has an overcurrent protection function. The programmed current level is set to the inverter's maximum applicable motor. If the motor used has a small capacity, the overcurrent level and the electronic thermal protection must be readjusted. If adjustment is necessary, refer to section 5.13, and make adjustments as directed.

Inverter capacity

Do not use a small-capacity (kVA) inverter to control the operation of a large-capacity motor (two-class or more larger motor), no matter how light the load is. Current ripple will raise the output peak current making it easier to set off the overcurrent trip.

Power factor correction capacitor

Power factor correction capacitors cannot be installed on the output side of the inverter. When a motor is run that has a power factor correction capacitor attached to it, remove the capacitors. This can cause inverter malfunction and capacitor destruction.

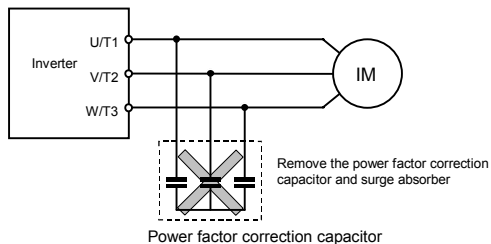

Operating at other than rated voltage

Connections to voltages other than the rated voltage described in the rating label cannot be made. If a connection must be made to a power supply other than one with rated voltage, use a transformer to raise or lower the voltage to the rated voltage.

Circuit breaking when two or more inverters are used on the same power line

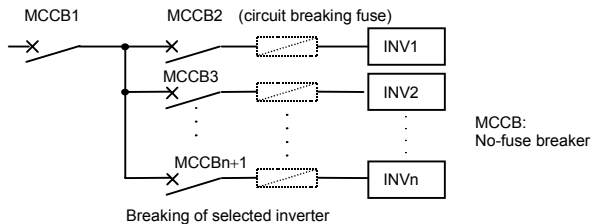

There is no fuse in the inverter's main circuit. Thus, as the diagram above shows, when more than one inverter is used on the same power line, you must select interrupting characteristics so that only MCCB2 to MCCBn+1 will trip and the MCCB1 will not trip when a short occurs in the inverter (INV1). When you cannot select the proper characteristics install a circuit interrupting fuse behind MCCB2 to MCCBn+1.

If power supply distortion is not negligible

If the power supply distortion is not negligible because the inverter shares a power distribution line with other systems causing distorted waves, such as systems with thyristors or large-capacity inverters, install an input reactor to improve the input power factor, to reduce higher harmonics, or to suppress external surges.

■ Disposal

Refer to chapter 16.

1.4.3 What to do about the leakage current



Caution



Mandatory
action

Current may leak through the inverter's input/output wires because of insufficient electrostatic capacity on the motor with bad effects on peripheral equipment.
The leakage current's value is affected by the carrier frequency and the length of the input/output wires.
Test and adopt the following remedies against leak current.

(1) Effects of leak current across ground

Leakage current may flow not just through the inverter system but also through ground wires to other systems. Leakage current will cause earth leakage breakers, leakage current relays, ground relays, fire alarms and sensors to operate improperly, and it will cause superimposed noise on the TV screen or display of incorrect current detection with the CT.

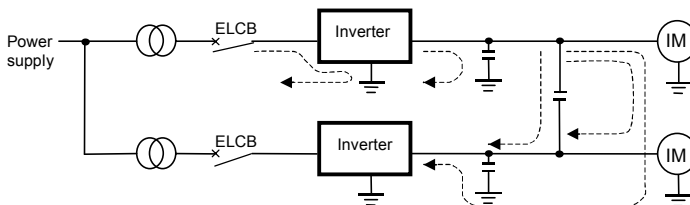

Leakage current path across ground

Remedies:

1. If there is no radio-frequency interference or similar problem, detach the built-in noise filter capacitor, using the grounding capacitor disconnecting switch.
2. Reduce PWM carrier frequency.
The setting of PWM carrier frequency is done with the parameter *F300*.
Although the electromagnetic noise level is reduced, the motor acoustic noise is increased.
3. Use high frequency remedial products for earth leakage breakers

(2) Affects of leakage current across lines

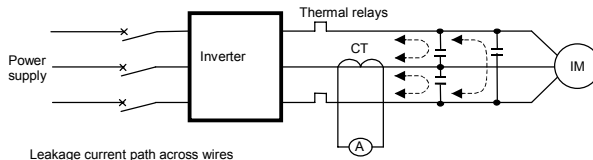

(1) Thermal relays

The high frequency component of current leaking into electrostatic capacity between inverter output wires will increase the effective current values and make externally connected thermal relays operate improperly. If the wires are more than 50 meters long, it will be easy for the external thermal relay to operate improperly with models having motors of low rated current (several A (ampere) or less), because the leakage current will increase in proportion to the motor rating.

Remedies:

1. Use the electronic thermal built into the inverter. (Refer to section 3.5)
The setting of the electronic thermal is done using parameter Q L P, t H r .
2. Reduce the inverter's PWM carrier frequency. However, that will increase the motor's magnetic noise.
The setting of PWM carrier frequency is done with the parameter F 3 0 0 . (Refer to section 6.14)
3. This can be improved by installing 0.1μ to $0.5\mu\text{F}$ - 1000V film capacitor to the input/output terminals of each phase in the thermal relay.

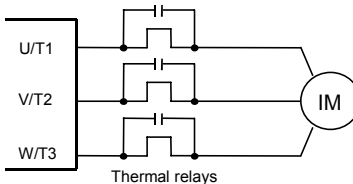

(2) CT and ammeter

If a CT and ammeter are connected externally to detect inverter output current, the leak current's high frequency component may destroy the ammeter. If the wires are more than 50 meters long, it will be easy for the high frequency component to pass through the externally connected CT and be superimposed on and burn the ammeter with models having motors of low rated current (several A (ampere) or less), especially the 400V class low capacity (4.0kW or less) models, because the leakage current will increase in proportion to the motor's rated current.



Remedies:



1. Use a meter output terminal in the inverter control circuit.
The load current can be output on the meter output terminal (FM). If the meter is connected, use an ammeter of 1mA dc full scale or a voltmeter of 10V full scale.
0-20mA dc (4-20mA dc) can be also output. (Refer to section 3.4)
2. Use the monitor functions built into the inverter.
Use the monitor functions on the panel built into the inverter to check current values. (Refer to section 8.2.1)

1.4.4 Installation

■ Installation environment

This inverter is an electronic control instrument. Take full consideration to installing it in the proper operating environment.

 Warning	
 Prohibited	<ul style="list-style-type: none"> • Do not place any inflammable substances near the inverter. If an accident occurs in which flame is emitted, this could lead to fire. • Do not install in any location where the inverter could come into contact with water or other fluids. This can result in electric shock or fire.
 Mandatory action	<ul style="list-style-type: none"> • Operate under the environmental conditions prescribed in the instruction manual. Operations under any other conditions may result in malfunction.

 Caution	
 Prohibited	<ul style="list-style-type: none"> • Do not install the inverter in any location subject to large amounts of vibration. This could cause the unit to fall, resulting in bodily injury.



- Do not install in any location of high temperature, high humidity, moisture condensation and freezing and avoid locations where there is exposure to water and/or where there may be large amounts of dust, metallic fragments and oil mist.
- Do not install in any location where corrosive gases or grinding fluids are present.

- Operate in areas where ambient temperature ranges from -10°C to 60°C. When using the inverter in locations with temperatures above 40°C, the current reduction is necessary. (Refer to section 6.14)



[Position for measuring ambient temperature]

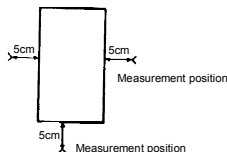

Note: The inverter is a heat-emitting body. Make sure proper space and ventilation is provided when installing in the cabinet.

- Do not install in any location that is subject to large amounts of vibration.







Note: If the inverter is installed in a location that is subject to vibration, anti-vibration measures are required. Please consult with Toshiba about these measures.

- If the inverter is installed near any of the equipment listed below, provide measures to insure against errors in operation.



- | | |
|----------------------|-----------------------------------|
| Solenoids: | Attach surge suppressor on coil. |
| Brakes: | Attach surge suppressor on coil. |
| Magnetic contactors: | Attach surge suppressor on coil. |
| Fluorescent lights: | Attach surge suppressor on coil. |
| Resistors: | Place far away from the inverter. |

■ How to install

 Warning	
 Prohibited	<ul style="list-style-type: none"> Do not install or operate the inverter if it is damaged or any component is missing. This can result in electric shock or fire. Please consult your local sales agency for repairs. Call your local sales agency for repairs.
 Mandatory action	<ul style="list-style-type: none"> Mount the inverter on a metal plate. The rear panel gets very hot. Do not install in an inflammable object, this can result in fire. Do not operate with the front panel cover removed. This can result in electric shock. An emergency stop device must be installed that fits with system specifications (e.g. shut off input power then engage mechanical brake). Operation cannot be stopped immediately by the inverter alone, thus risking an accident or injury. All options used must be those specified by Toshiba. The use of any other option may result in an accident.
 Caution	
 Mandatory action	<ul style="list-style-type: none"> The main unit must be installed on a base that can bear the unit's weight. If the unit is installed on a base that cannot withstand that weight, the unit may fall resulting in injury. If braking is necessary (to hold motor shaft), install a mechanical brake. The brake on the inverter will not function as a mechanical hold, and if used for that purpose, injury may result.

(1) Normal installation

Select an indoor location with good ventilation, and then install it upright on a flat metal plate.

When installing multiple inverters, leave at least 3 cm of space between each inverter and install them aligned horizontally.

When using the inverter in locations with temperatures above 40°C, the current reduction is necessary.

(2) Side-by-side installation

To align the inverters side-by-side horizontally, the current reduction is necessary.

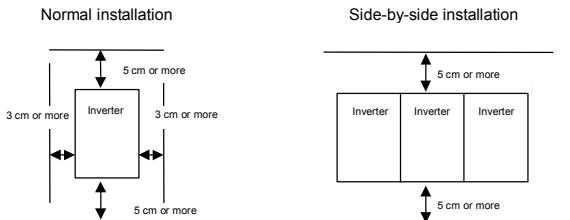

The space shown in the diagram is the minimum allowable space. Because air cooled equipment has cooling fans built in on the top or bottom surfaces, make the space on top and bottom as large as possible to allow for air passage.

Note: Do not install in any location where there is high humidity or high temperatures and where there are large amounts of dust, metallic fragments and oil mist.

(3) Flat mount installation

VFMB1S-2002 to 2022PL and VFMB1-4004 to 4037PL can be installed as flat mounting.

1

■ Calorific values of the inverter and the required ventilation

About 5% of the rated power of the inverter will be lost as a result of conversion from AC to DC or from DC to AC. In order to suppress the rise in temperature inside the cabinet when this loss becomes heat loss, the interior of the cabinet must be ventilated and cooled.

The amount of forcible air-cooling ventilation required and the necessary heat discharge surface quantity when operating in a sealed cabinet according to motor capacity are as follows.

Voltage class	Inverter type	Calorific values (W) Note 1)		Amount of forcible air cooling ventilation required (m ³ /min)		Heat discharge surface area required for sealed storage cabinet (m ²)		Standby power requirement (W) Note 2)	
		4kHz	12kHz	4kHz	12kHz	4kHz	12kHz		
Single-phase 240V class	VFMB1S-	2002PL	25	27	0.14	0.15	0.49	0.54	11
		2004PL	38	43	0.22	0.24	0.76	0.86	11
		2007PL	51	56	0.29	0.32	1.03	1.11	11
		2015PL	81	93	0.46	0.53	1.62	1.86	11
		2022PL	103	112	0.58	0.63	2.05	2.23	11
Three-phase 500V class	VFMB1-	4004PL	28	31	0.16	0.18	0.55	0.63	15.3
		4007PL	37	48	0.21	0.27	0.75	0.96	15.3
		4015PL	63	77	0.36	0.44	1.26	1.54	15.3
		4022PL	78	97	0.44	0.55	1.57	1.94	17.1
		4037PL	125	154	0.71	0.87	2.50	3.07	17.1
		4055PL	233	291	1.32	1.65	4.66	5.81	22
		4075PL	263	352	1.49	2.00	5.26	7.05	22
		4110PL	403	507	2.29	2.88	8.06	10.1	31
4150PL	480	611	2.72	3.47	9.59	12.2	31		

Notes

- 1) Case of 100% Load Continuation operation. The heat loss for the optional external devices (input reactor, DC reactor, radio noise reduction filters, etc.) is not included in the calorific values in the table
- 2) It is power consumption when power is on but output frequency is 0Hz, and cooling fan is activated.

■ Panel designing taking into consideration the effects of noise

The inverter generates high frequency noise. When designing the control panel setup, consideration must be given to that noise. Examples of measures are given below.

- Wire so that the main circuit wires and the control circuit wires are separated. Do not place them in the same conduit, do not run them parallel, and do not bundle them.
- Provide shielding and twisted wire for control circuit wiring.
- Separate the input (power) and output (motor) wires of the main circuit. Do not place them in the same conduit, do not run them parallel, and do not bundle them.
- Ground the inverter ground terminals (⏏).
- Install surge suppressor on any magnetic contactor and relay coils used around the inverter.
- Install noise filters if necessary.
- To comply with the EMC directives, install the optional EMC plate and fix the shield to it.
- Install EMC plate and use shielded wires.



■ Installing more than one unit in a cabinet

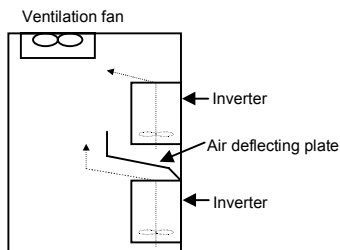

When two or more inverters are installed in one cabinet, pay attention to the followings.

- Inverters may be installed side by side with each other with no space left between them.
- When installing inverters side by side, use them where the ambient temperature will not rise above 40°C.
- When using inverters where the ambient temperature will rise above 40°C, leave a space of 3 cm or more between them, or operate each inverter at a current lower than the rated one.
- Ensure a space of at least 20 centimeters on the top and bottom of the inverters.
- Install an air deflecting plate so that the heat rising up from the inverter on the bottom does not affect the inverter on the top.





2. Connection

 Warning	
 Disassembly prohibited	<ul style="list-style-type: none"> • Never disassemble, modify or repair. This can result in electric shock, fire and injury. For repairs, call your sales agency.
 Prohibited	<ul style="list-style-type: none"> • Don't stick your fingers into openings such as cable wiring hole and cooling fan covers. This can result in electric shock or other injury. • Don't place or insert any kind of object into the inverter (electrical wire cuttings, rods, wires). This can result in electric shock or fire. • Do not allow water or any other fluid to come in contact with the inverter. That may result in electric shock or fire.

 Caution	
 Prohibited	<ul style="list-style-type: none"> • When transporting or carrying, do not hold by the front panel covers. The covers may come off and the unit will drop out resulting in injury.

2.1 Cautions on wiring

 Warning	
 Prohibited	<ul style="list-style-type: none"> • Never remove the terminal cover when power is on or open door if enclosed in a cabinet. The unit contains many high voltage parts and contact with them will result in electric shock.
 Mandatory action	<ul style="list-style-type: none"> • Turn power on only after attaching the front cover or closing door if enclosed in a cabinet. If power is turned on without the terminal cover attached or closing door if enclosed in a cabinet. This can result in electric shock or other injury. • Electrical construction work must be done by a qualified expert. Connection of input power by someone who does not have that expert knowledge may result in fire or electric shock. • Connect output terminals (motor side) correctly. If the phase sequence is incorrect, the motor will operate in reverse and that may result in injury. • Wiring must be done after installation. If wiring is done prior to installation that may result in injury or electric shock. • The following steps must be performed before wiring. <ol style="list-style-type: none"> (1) Shut off all input power. (2) Wait at least 15 minutes and check to make sure that the charge lamp is no longer lit. (3) Use a tester that can measure DC voltage (400VDC or 800VDC or more), and check to make sure that the voltage to the DC main circuits (across PA-PC) is 45V or less. If these steps are not properly performed, the wiring will cause electric shock. • Tighten the screws on the terminal board to specified torque. If the screws are not tightened to the specified torque, it may lead to fire.

**Warning**

Be Grounded

- Ground must be connected securely.
If the ground is not securely connected, it could lead to electric shock or fire.

**Caution**

Prohibited

- Do not attach devices with built-in capacitors (such as noise filters or surge absorber) to the output (motor side) terminal.
This could cause a fire.

2

■ Preventing radio noise

To prevent electrical interference such as radio noise, separately bundle wires to the main circuit's power terminals (R/L1, S/L2, T/L3) and wires to the motor terminals (U/T1, V/T2, W/T3).





■ Control and main power supply

The control power supply and the main circuit power supply for this inverter are the same. If a malfunction or trip causes the main circuit to be shut off, control power will also be shut off. When checking the cause of the malfunction or the trip, use the trip holding retention selection parameter. In addition, please use an optional control power supply backup unit when only control power supply operates, even if the main circuit is shut off due to trouble or tripping.

■ Wiring

- Because the space between the main circuit terminals is small, use sleeved pressure terminals for the connections. Connect the terminals so that adjacent terminals do not touch each other.
- For ground terminal  use wires of the size that is equivalent to or larger than those given in table 10.1 and always ground the inverter (240V voltage class: D type ground, 500V voltage class: C type ground). Use as large and short a ground wire as possible and wire it as close as possible to the inverter.
- For the sizes of electric wires used in the main circuit, refer to the table in section 10.1.
- The length of the main circuit wire in table 10.1 should be no longer than 30 meters. If the wire is longer than 30 meters, the wire size (diameter) must be increased.

2.2 Standard connections

 Warning	
 Prohibited	<ul style="list-style-type: none"> Do not connect input power to the output (motor side) terminals (U/T1, V/T2, W/T3). Connecting input power to the output could destroy the inverter or cause a fire. Do not insert a braking resistor between DC terminals (between PA/+ and PC/-). It could cause a fire. See 6.13.4 for the connection of a resistor. First shut off input power and wait at least 15 minutes before touching wires on equipment (MCCB) that is connected to inverter power side. Touching the wires before that time could result in electric shock. Do not shut down the external power supply on ahead when VIA or VIB terminals are used as logic input terminal by external power supply. It could cause unexpected result as VIA or VIB terminals are ON status.
 Mandatory action	<ul style="list-style-type: none"> Set a parameter $F \setminus \overline{0} \overline{9}$ when VIA or VIB terminals are used as logic input terminal. If it is not set, it could result in malfunction.
 Be Grounded	<ul style="list-style-type: none"> Ground must be connected securely. If the ground is not securely connected, it could lead to electric shock or fire when a malfunction or current leak occurs.

2.2.1 Standard connection diagram 1

This diagram shows a standard wiring of the main circuit.

Standard connection diagram - SINK (Negative) (common:CC)

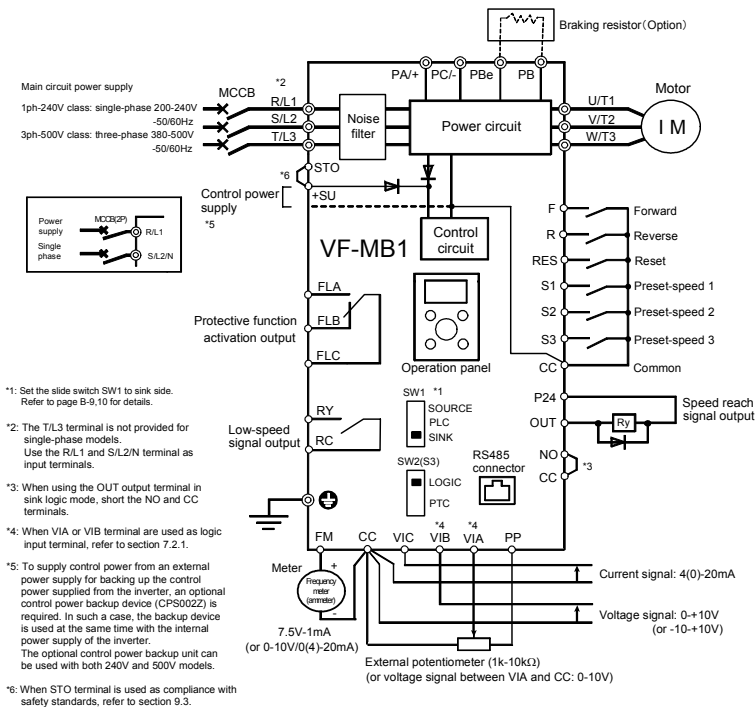

2.2.2 Standard connection diagram 2

Standard connection diagram - SOURCE (Positive) (common:P24)

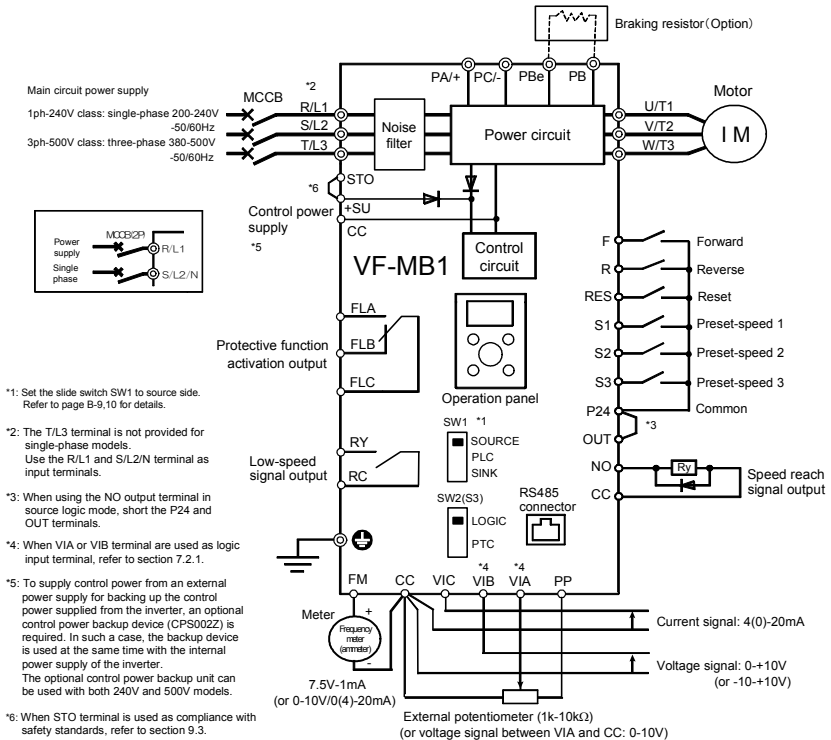

2.3 Description of terminals

2.3.1 Power circuit terminals

■ Connections with peripheral equipment

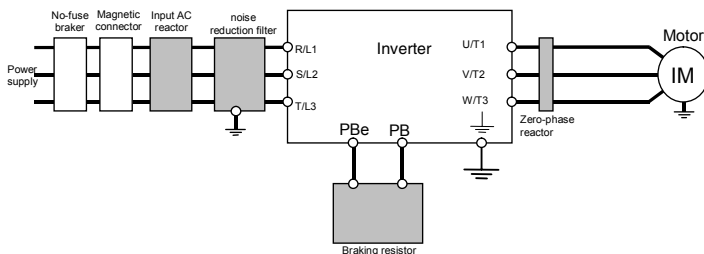

Note 1: The T/L3 terminal is not provided for any single-phase models. So if you are using single-phase models, use the R/L1 and S/L2/N terminals to connect power cables.

■ Power circuit

Terminal symbol	Terminal function
	Grounding terminal for connecting inverter. There are 3 terminals in total. Up to 4.0kW : 2 terminals on upper side, 1 terminal on down side. 5.5 to 15kW : 3 terminals on down side.
R/L1,S/L2,T/L3	240V class: Single-phase 200 to 240V-50/60Hz 500V class: Three-phase 380 to 500V-50/60Hz * Single-phase inputs are R/L1 and S/L2/N terminals.
U/T1,V/T2,W/T3	Connect to a (three-phase induction) motor.
PBe, PB	Connect to braking resistors. Change parameters <i>F304</i> , <i>F305</i> , <i>F308</i> , <i>F309</i> if necessary.
PA+	This is a positive potential terminal in the internal DC main circuit. DC common power can be input with PC/- terminal.
PC/-	This is a negative potential terminal in the internal DC main circuit. DC common power can be input with PA/+ terminal.

The arrangements of power circuit terminals are different from each range.

Refer to section 1.3.3.1) for details.

2.3.2 Control circuit terminals

The control circuit terminal board is common to all equipment.

Regarding to the function and specification of each terminal, please refer to the following table.

Refer to section 1.3.3.3) about the arrangement of control circuit terminals.

■ Control circuit terminals

Terminal symbol	Input / output	Function	Electrical specifications	Inverter internal circuits
F	Input	Shorting across F-CC or P24-F causes forward rotation; open causes deceleration stop. (When Standby ST is always ON) 3 different functions can be assigned.	No voltage logic input 24Vdc-5mA or less <u>*Sink/Source and PLC selectable using slide switch SW1</u> Pulse train input (S2 terminal) Pulse frequency range: 10~20kpps PTC input (S3 terminal) PTC type: PT100	
R	Input	Shorting across R-CC or P24-R causes reverse rotation; open causes deceleration stop. (When Standby ST is always ON) 3 different functions can be assigned.		
RES	Input	This inverter protective function is reset if RES are CC or P24 is connected. Shorting RES and CC or P24 has no effect when the inverter is in a normal condition. 2 different functions can be assigned.		
S1	Input	Shorting across S1-CC or P24-S1 causes preset speed operation. 2 different functions can be assigned.		
S2	Input	Shorting across S2-CC or P24-S2 causes preset speed operation. By changing parameter $F145$ setting, this terminal can also be used as a input pulse trains terminal.		
S3	Input	Shorting across S3-CC or P24-S3 causes preset speed operation. By changing slide switch SW2 and parameter $F147$ setting, this terminal can also be used as a PTC input terminal.		

Terminal symbol	Input / output	Function	Electrical specifications	Inverter internal circuits
CC	Common to Input / output	Control circuit's equipotential terminal (3 terminals)		
PP	Output	Analog power supply output	10Vdc (permissible load current: 10mA)	
VIA Note 1)	Input	Multifunction programmable analog input. Factory default setting: 0-10Vdc (1/1000 resolution) and 0-60Hz (0-50Hz) frequency input. By changing parameter F_{ID9} setting, this terminal can also be used as a multifunction programmable logic input terminal.	10Vdc (internal impedance: 30k Ω)	
VIB Note 1)	Input	Multifunction programmable analog input. Factory default setting: 0-10Vdc (1/1000 resolution) and 0-60Hz (0-50Hz) frequency input. The function can be changed to -10-+10V input by parameter $F_{ID7=1}$ setting. By changing parameter F_{ID9} setting, this terminal can also be used as a multifunction programmable logic input terminal.	10Vdc (internal impedance: 30k Ω)	
VIC	Input	Multifunction programmable analog input. 0-20mA (4-20mA) input.	4-20mA (internal impedance: 250 Ω)	

Note 1) When VIA and VIB terminals are used as logic input terminal, connect the pull-up or pull-down resistors.

Terminal symbol	Input / output	Function	Electrical specifications	Inverter internal circuits
FM	Output	Multifunction programmable analog output. Standard default setting: output frequency. The function can be changed to ammeter, 0-10Vdc voltage or 0-20mA (4-20mA) current output by parameter <i>F E B</i> ! setting.	Analog output 1mAdc full-scale ammeter 0-10V DC volt meter 0-20mA (4-20mA) DC ammeter Permissible load resistance: 750Ω or less 0-10V DC volt meter	
P24	Output	24Vdc power output	24Vdc-100mA	
	Input	This terminal can be used as a common terminal when an external power supply is used by changing SW1 to PLC side.	-	
+SU	Input	DC power input terminal for operating the control circuit. Connect a control power backup device (option) between +SU and CC.	Voltage: 24Vdc±10% Current: 1A or more	
	Output	It is used with STO for safety function. +SU and STO terminals are short-circuited by metal bar at factory setting.	-	
STO Note 2)	Input	When +SU and STO are short-circuited, the inverter is put into a standby state. (Factory setting) And when the circuit between them is opened, the motor is coasting stop. These terminals can be used for inter lock. This terminal is not a multifunction programmable input terminal. It is a terminal with the safety function that complies with SIL II of the safety standard IEC61508.	Independently of SW1 ON: DC17V or more OFF: Less than DC12V (OFF: Coast stop)	

Note2) When STO terminal is used as the safety function, refer to section 9.3.

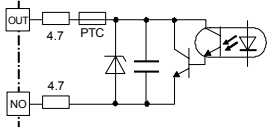
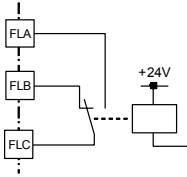
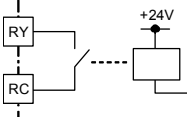
Terminal symbol	Input / output	Function	Electrical specifications	Inverter internal circuits
OUT NO	Output	Multifunction programmable open collector output. Standard default settings detect and output speed reach signal. Multifunction output terminals to which two different functions can be assigned. The NO terminal is an isoelectric output terminal. It is isolated from the CC terminal. By changing parameter <i>F559</i> settings, these terminals can also be used as multifunction programmable pulse train output terminals.	Open collector output 24Vdc-100mA To output pulse trains, a current of 10mA or more needs to be passed. Pulse frequency range: 10~2kpps	
FLA FLB FLC Note 3)	Output	Multifunction programmable relay logic output. Detects the operation of the inverter's protection function. (Standard default setting) Contact across FLA-FLC is closed and FLB-FLC is opened during protection function operation.	Max. switching capacity 250Vac-2A ($\cos\phi=1$) : at resistive load 30Vdc-1A 250Vac-1A ($\cos\phi=0.4$) Min. permissible load 5Vdc-100mA 24Vdc-5mA	
RY RC Note 3)	Output	Multifunction programmable relay contact output. Standard default settings detect and output low-speed signal output frequencies. Multifunction output terminals to which two different functions can be assigned.	Max. switching capacity 250Vac-2A ($\cos\phi=1$) : at resistive load 30Vdc-1A 250Vac-1A ($\cos\phi=0.4$) Min. permissible load 5Vdc-100mA 24Vdc-5mA	

Note3) A chattering (momentary ON/OFF of contact) is generated by external factors of the vibration and the impact, etc. In particular, please set the filter of 10ms or more, or timer for measures when connecting it directly with input unit terminal of programmable controller. Please use the OUT terminal as much as possible when the programmable controller is connected.

■ SINK (Negative) logic (When an external power supply is used)

The P24 terminal is used to connect to an external power supply or to separate a terminal from other input or output terminals.

<Examples of connections when an external power supply is used>

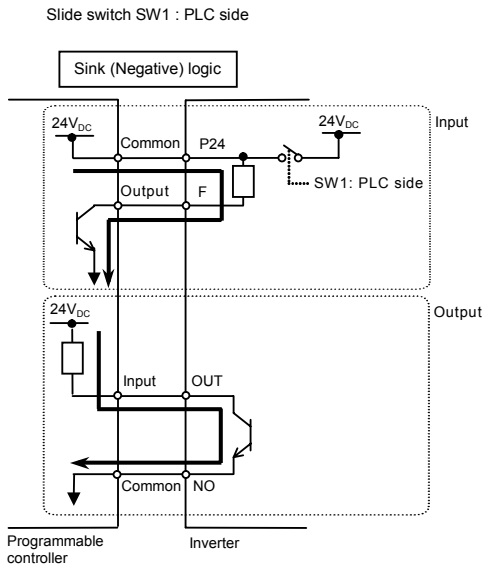

■ Switching of slide switch

Refer to section 1.3.3 3) about location of slide switch.

(1) Switching of sink/source logic: SW1

Setting of sink/source logic for F, R, RES, S1, S2, and S3 terminals are switched by slide switch SW1.

When an external power supply is used for sink logic, set the slide switch SW1 to PLC side.

Set the sink/source logic switching before power supply switches on.

After confirming the right for sink/source setting, power supply switches on.

(2) Switching of S3 terminal function: SW2

Setting of logic input/ PTC input for S3 terminal is switched by slide switch SW2 and parameter F_{147} .



When using S3 terminal as a logic input terminal, set the slide switch SW2 to LOGIC side and set the parameter $F_{147} = 0$.



When using S3 terminal as a PTC input terminal, set the slide switch SW2 to PTC side and set the parameter $F_{147} = 1$.

Match the setting of slide switch SW2 and parameter F_{147} surely.

If it is not, this can result in malfunction.

3. Operations

 Caution	
 Prohibited	<ul style="list-style-type: none"> Do not touch inverter terminals when electrical power is going to the inverter even if the motor is stopped. Touching the inverter terminals while power is connected to it may result in electric shock. Do not touch switches when the hands are wet and do not try to clean the inverter with a damp cloth. Such practices may result in electric shock. Do not go near the motor in alarm-stop status when the retry function is selected. The motor may suddenly restart and that could result in injury. Take measures for safety, e.g. attaching a cover to the motor, against accidents when the motor unexpectedly restarts.
 Mandatory action	<ul style="list-style-type: none"> Turn the input power on only after attaching the terminal block cover (i.e., after closing the cabinet doors). If the input power is turned on without the terminal block cover attached (i.e., without closing the cabinet doors), this may result in electric shock. If the inverter begins to emit smoke or an unusual odor, or unusual sounds, immediately turn power off. If the equipment is continued in operation in such a state, the result may be fire. Call your local sales agency for repairs. Always turn power off if the inverter is not used for long periods of time. Turn the input power on only after attaching the terminal block cover. When enclosed inside a cabinet and used with the terminal block cover removed, always close the cabinet doors first and then turn the power on. If the power is turned on with the terminal block cover or the cabinet doors open, this may result in electric shock. Make sure that operation signals are off before resetting the inverter after malfunction. If the inverter is reset before turning off the operating signal, the motor may restart suddenly causing injury.

 Caution	
 Contact prohibited	<ul style="list-style-type: none"> Do not touch heat radiating fins or discharge resistors. These devices are hot, and you'll get burned if you touch them.
 Prohibited	<ul style="list-style-type: none"> Observe all permissible operating ranges of motors and mechanical equipment. (Refer to the motor's instruction manual.) Not observing these ranges may result in injury.

3

3.1 How to Set the Setup Menu

Warning





Mandatory
action

- With incorrect setting, the drive will be damaged and have unexpected movement. Be sure to set the setup parameter correctly.

Set the setup menu according to the base frequency and the base frequency voltage of the motor connected. (If you are not sure which region code of setup menu should be selected and what values should be specified, consult your distributor.)

Each setup menu automatically sets all parameters relating to the base frequency and the base frequency voltage of the motor connected. (See the table on the following page.)

Follow these steps to change the setup menu [Example: Selecting a region code to *EU*]

Panel operated	LED display	Operation				
	<i>SEt</i>	<i>SEt</i> is blinking				
	<table border="1" style="display: inline-table; text-align: center;"> <tr> <td><i>EU</i></td> <td><i>JP</i></td> </tr> <tr> <td><i>RS1R</i></td> <td><i>USA</i></td> </tr> </table> 	<i>EU</i>	<i>JP</i>	<i>RS1R</i>	<i>USA</i>	Turn the setting dial, and select region code " <i>EU</i> " (Europe).
<i>EU</i>	<i>JP</i>					
<i>RS1R</i>	<i>USA</i>					
	<i>EU <=> in it</i>	Press the center of the setting dial to determine the region.				
	<i>0.0</i>	The operation frequency is displayed (Standby).				

☆ If you want to change the selected region by the setup menu, the setup menu will appear by the following settings.

Please note, however, that all setting parameters return to status of default setting.

- Set parameter *tYP* to "*13*".
- Set parameter *SEt* to "*0*".

☆ The parameter settings in the table on the following page can be changed individually even after they are selected in the setup menu.

■ Values set by each setup parameter

Title	Function		EU (Mainly in Europe)	USA (Mainly in North America)	RSIR (Mainly in Asia, Oceania) Note 1)	JP (Mainly in Japan)
UL / UL / F170	Frequency settings		50.0(Hz)	60.0(Hz)	50.0(Hz)	60.0(Hz)
F204 / F213 / F219 / F330 / F367 / F814	Input point 2 frequency		50.0(Hz)	60.0(Hz)	50.0(Hz)	60.0(Hz)
ULU / F171	Base frequency voltage 1, 2	240V class	230(V)	230(V)	230(V)	200(V)
		500V class	400(V)	460(V)	400(V)	400(V)
Pt	V/F control mode selection		0	0	0	2
F307	Supply voltage correction (output voltage limitation)		2	2	2	3
F417	Motor rated speed		1410(min ⁻¹)	1710(min ⁻¹)	1410(min ⁻¹)	1710(min ⁻¹)

Note 1) Excludes Japan.

3

3.2 Simplified Operation of the VF-MB1

The procedures for setting operation frequency and the methods of operation can be selected from the following.

Run / Stop

- : (1) Run and stop using the panel keypad
- (2) Run and stop using external signals to terminal board

Setting the frequency

- : (1) Setting using setting dial
- (2) Setting using external signals to terminal board (0-10Vdc, 4-20mA_{dc})

Use the basic parameters CND (command mode selection) FND and (frequency setting mode selection) for selection.

[Parameter setting]





Title	Function	Adjustment range	Default setting
CND	Command mode selection	0: Terminal board 1: Panel keypad (including remote keypad) 2: RS485 communication 3: CANopen communication 4: Communication option	1
FND	Frequency setting mode selection	0: Setting dial 1(save even if power is off) 1: Terminal board VIA 2: Terminal board VIB 3: Setting dial 2(press in center to save) 4: RS485 communication 5: UP/DOWN from external logic input 6: CANopen communication 7: Communication option 8: Terminal board VIC 9, 10: - 11: Pulse train input	0

☆ $FND=0$ (setting dial 1) is the mode that after the frequency is set by the setting dial, the frequency is saved even if the power is turned off.



☆ Refer to section 5.6 for details about $FND=4$ to 7 and 11.

3.2.1 How to run and stop

[Example of $\text{C} \text{r} \text{d}$ setting procedure]

Panel operation	LED display	Operation
	0.0	Displays the operation frequency (operation stopped). (When standard monitor display selection $F \text{?} \text{!} \text{0} = \text{0}$ [Operation frequency])
	RUH	Displays the first basic parameter [History (RUH)].
	$\text{C} \text{r} \text{d}$	Turn the setting dial, and select " $\text{C} \text{r} \text{d}$ ".
	!	Press the center of the setting dial to read the parameter value. (Standard default: !).
	0	Turn the setting dial to change the parameter value to 0 (terminal block).
	$0 \leftrightarrow \text{C} \text{r} \text{d}$	Press the center of the setting dial to save the changed parameter. $\text{C} \text{r} \text{d}$ and the parameter set value are displayed alternately.

(1) Run and stop using the panel keypad ($\text{C} \text{r} \text{d} = !$)



Use the  and  keys on the panel keypad to start and stop the motor.



 : Motor runs.  : Motor stops.

- ★ The direction of rotation is determined by the setting of parameter F_r (forward run, reverse run selection). (0: forward run, !: reverse run)
- ★ To switch between forward run and reverse run from the remote keypad (option), the parameter F_r (forward run, reverse run selection) needs to be set to 2 or 3. (Refer to section 5.8)

(2) RUN / STOP by means of an external signal to the terminal board ($\text{C} \text{r} \text{d} = 0$): Sink (Negative) logic

Use external signals to the inverter terminal board to start and stop the motor.

Short  and  terminals: run forward

Open  and  terminals: slow down and stop

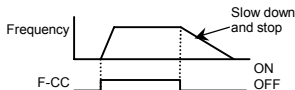

(3) Coast stop

The standard default is deceleration stop. To make a coast stop, assign "6 (ST)" to an idle terminal.

Set parameter $F110=0$.

For coast stop, open the ST-CC when stopping the motor in the state described at right. The monitor on the inverter at this time will display $0FF$.

A coast stop can also be made by assigning "96 (FRR)" to an idle terminal.

When doing this, a coast stop is done by shorting FRR and CC.

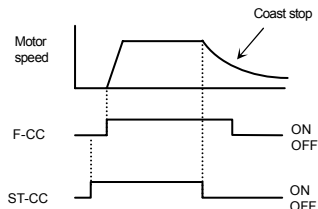

3.2.2 How to set the frequency

[Example of $F\Omega d$ setting procedure]: Setting the frequency by the terminal VIA

Panel operation	LED display	Operation
	0.0	Displays the operation frequency (operation stopped). (When standard monitor display selection $F710=0$ [Operation frequency])
	$R\Omega H$	Displays the first basic parameter [History ($R\Omega H$)].
	$F\Omega d$	Turn the setting dial, and select " $F\Omega d$ ".
	0	Press the center of the setting dial to read the parameter value. (Standard default: 0).
	i	Turn the setting dial to change the parameter value to i (terminal block VIA).
	$i \Rightarrow F\Omega d$	The parameter value is written. $F\Omega d$ and the parameter value are displayed alternately several times.

* Pressing the MODE key twice returns the display to standard monitor mode (displaying operation frequency).

(1) Setting using the keypad ($F\Omega d=0$ or 3)



Moves the frequency up



Moves the frequency down

■ Example of operating from the panel ($F\Omega d=3$: press in center to save)

Panel operation	LED display	Operation
	0.0	Displays the operation frequency. (When standard monitor display selection $F710=0$ [Operation frequency])
	50.0	Set the operation frequency. (The frequency will not be saved if the power is turned off in this state.)
	$50.0 \Rightarrow F\Omega$	Save the operation frequency. $F\Omega$ and the frequency are displayed alternately.

■ Example of operating from the panel (F710=0: save even if power is off)

Panel operation	LED display	Operation
	0.0	Display the operation frequency. (When standard monitor display selection is set as F710=0 [operation frequency])
	60.0	Set the operation frequency.
-	60.0	The frequency will be saved even if the power is turned off in this state.

(2) Setting of frequency using external signals to terminal block ($F_{IND} = 1, 2 \text{ or } B$)

■ Frequency setting

1) Setting the frequency using external potentiometer

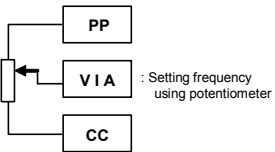

★Potentiometer
Setting frequency using the potentiometer (1k -10kΩ, 1/4W)
Refer to section 6.5.2 for detailed adjustment.

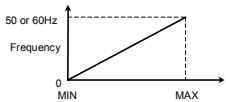

Note) Set parameter $F_{I09} = 0, 1, \text{ or } 2$.

2) Setting the frequency using voltage input (0-10V)

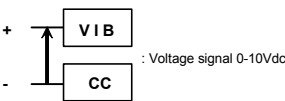

★Voltage signal
Setting frequency using voltage signals (0-10V).
Refer to section 6.5.2 for detailed adjustment.

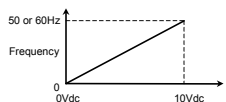

Note) Set parameter $F_{I07} = 0, F_{I09} = 0$.

3) Setting the frequency using current input (4-20mA)

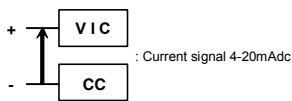

★Current Signal
Current signal Setting frequency using current signals (4-20mA).
Refer to section 6.5.2 for detailed adjustment.

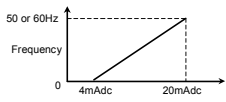

* Setting of parameters also allow 0-20mAdc.
Note) Set parameter $F_{215} = 20$.

4) Setting the frequency using voltage input (-10+10V)

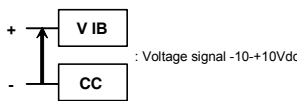

★Voltage signal
Set the frequency using voltage signals (-10+10V).
Refer to section 6.5.2 for detailed adjustment.

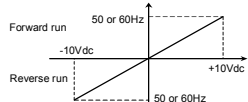

Note) Set parameter $F_{I07} = 1, F_{I09} = 0$.

3.3 How to operate the VF-MB1

Overview of how to operate the inverter with simple examples

Ex.1

Setting the frequency using the setting dial, and run/stop using the panel keypad (1)

(1) Wiring

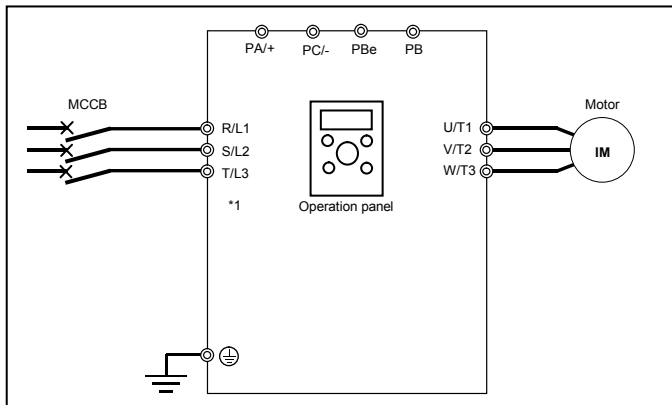

(2) Parameter setting (default setting)

Title	Function	Programmed value
<i>f P d</i>	Command mode selection	1
<i>F P d</i>	Frequency setting mode selection	0

(3) Operation

Run/stop: Press the and keys on the panel.

Frequency setting: Turn the setting dial to set the frequency. The frequency setting is saved just by turning the setting dial.

*1: Single-phase models are R/L1 and S/L2/N.

Ex.2

Setting the frequency using the setting dial, and run/stop using the panel keypad (2)

(1) Wiring

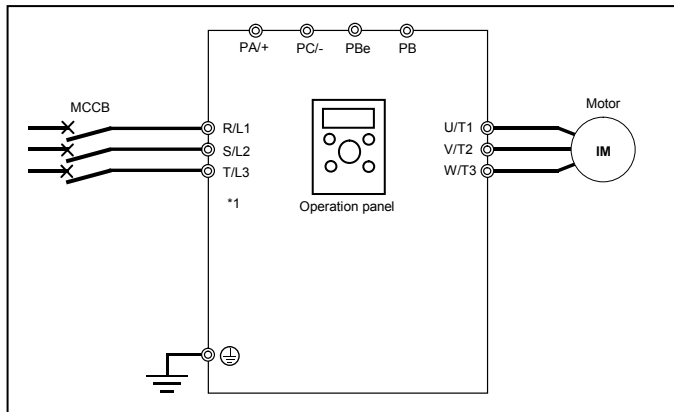

(2) Parameter setting

Title	Function	Programmed value
$\overline{C} \overline{M} \overline{M} \overline{d}$	Command mode selection	1
$\overline{F} \overline{M} \overline{M} \overline{d}$	Frequency setting mode selection	3

(3) Operation

Run/stop: Press the **RUN** and **STOP** keys on the panel.

Frequency setting: Turn the setting dial to set the frequency.

To save the frequency setting, press the center of the setting dial.

$\overline{F} \overline{C}$ and the set frequency will flash on and off alternately.

*1: Single-phase models are R/L1 and S/L2/N.

Ex.3

Setting the frequency using the setting dial, and run/stop using external signals

(1) Wiring

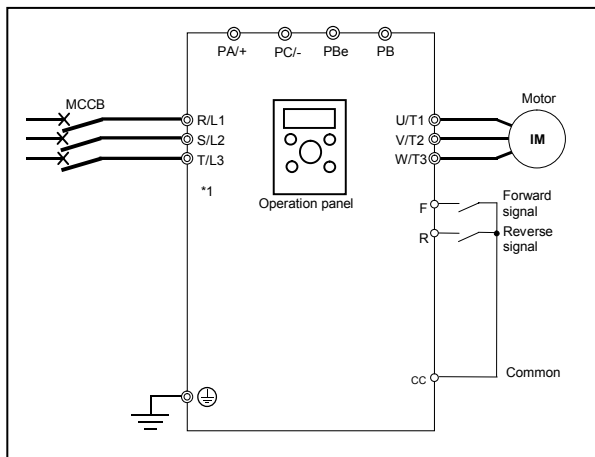

(2) Parameter setting

Title	Function	Programmed value
<i>C M d</i>	Command mode selection	0
<i>F M d</i>	Frequency setting mode selection	0 or 3

(3) Operation

Run/stop: ON/OFF input to F-CC, R-CC. (with sink logic)

Frequency setting: Turn the setting dial to set the frequency.

*1: Single-phase models are R/L1 and S/L2/N.

Ex.4

Setting the frequency using external signals, run/stop using external signals.

(1) Wiring

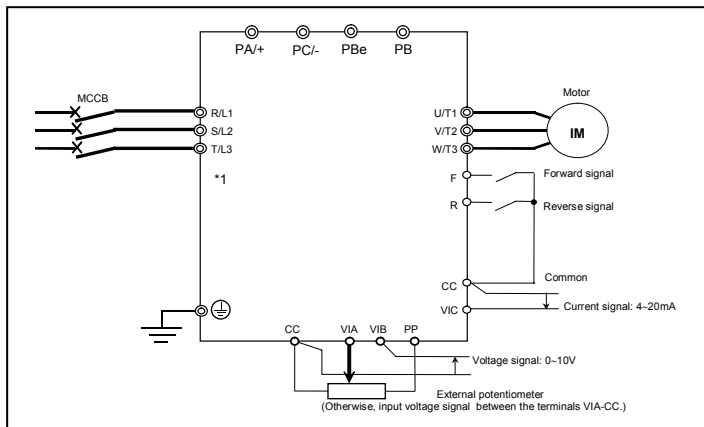

(2) Parameter setting

Title	Function	Programmed value
$F\bar{R}\bar{Q}\bar{d}$	Command mode selection	0
$F\bar{R}\bar{Q}\bar{d}$	Frequency setting mode selection	1, 2 or 8

(3) Operation

Run/stop: ON/OFF input to F-CC, R-CC. (with sink logic)

Frequency setting: VIA: Input 0-10Vdc (external potentiometer), VIB: Input 0-10Vdc or VIC: 4-20mAdc to set the frequency.

☆ Set the selection of VIA, VIB or VIC in parameter $F\bar{R}\bar{Q}\bar{d}$.

VIA : $F\bar{R}\bar{Q}\bar{d} = 1$

VIB : $F\bar{R}\bar{Q}\bar{d} = 2$

VIC : $F\bar{R}\bar{Q}\bar{d} = 8$

*1: Single-phase models are R/L1 and S/L2/N.

3.4 Meter setting and adjustment

F \overline{N} SL: Meter selection

F \overline{N} : Meter adjustment gain

- Function
Output of 0 - 1mAdc, 0 (4) - 20mAdc, 0 - 10vdc can be selected for the output signal from the FM terminal, depending on the **F \overline{G} B** setting. Adjust the scale at **F \overline{N}** .
Use an ammeter with a full-scale 0 - 1mAdc meter.
The **F \overline{G} Q** (analog output bias) needs to be adjusted if output is 4 - 20mAdc.

[Parameter setting]

Title	Function	Adjustment range	Supposition output at F\overline{N}SL = 17	Default setting
F\overline{N}SL	Meter selection	0: Output frequency 1: Output current 2: Frequency reference 3: Input voltage (DC detection) 4: Output voltage (command value) 5: Input power 6: Output power 7: Torque 8: - 9: Motor cumulative load factor 10: Inverter cumulative load factor 11: PBR (Braking resistor) cumulative load factor 12: Frequency setting value (after compensation) 13: VIA input value 14: VIB input value 15: Fixed output 1 (output current 100% equivalent) 16: Fixed output 2 (output current 50% equivalent) 17: Fixed output 3 (Other than the output current) 18: RS485 communication data 19: For adjustments (F\overline{N} set value is displayed.) 20: VIC input value 21: Pulse train input value 22: - 23: PID feedback value 24: Integral input power 25: Integral output power	Maximum frequency (F\overline{H}) - Maximum frequency (F\overline{H}) 1.5x rated voltage 1.5x rated voltage 1.85x rated power 1.85x rated power 2.5x rated torque - Rated load factor Rated load factor Rated load factor Maximum frequency (F\overline{H}) Maximum input value Maximum input value - - - Maximum value (100.0%) - Maximum input value Maximum input value - Maximum frequency (F\overline{H}) 1000x F$\overline{7}$49 1000x F$\overline{7}$49	0
F\overline{N}	Meter adjustment gain	-	-	-

- Resolution
All FM terminals have a maximum of 1/1000.
- Example of 4-20mA output adjustment (Refer to section 6.17.2 for details)

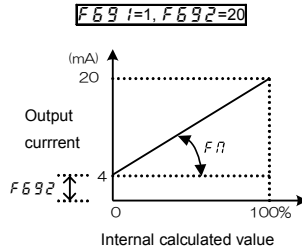
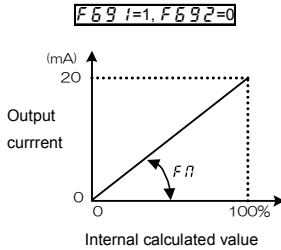





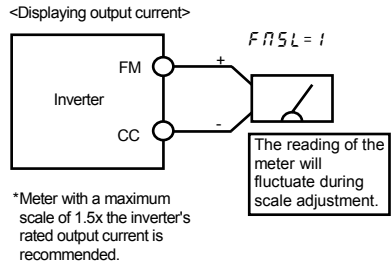
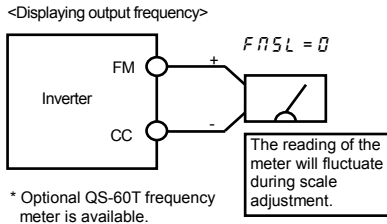

- Note 1) When using the FM terminal for current output, be sure that the external load resistance is less than 750Ω.
Use over 1kΩ external load resistance for voltage output.
- Note 2) $F75L = f$ is the motor drive frequency.

- Adjustment scale with parameter $F7$ (Meter adjustment)
Connect meters as shown below.



[Example of how to adjust the FM terminal frequency meter]

* Use the meter's adjustment screw to pre-adjust zero-point.

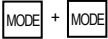
Operation panel action	LED display	Operation
-	50.0	Displays the output frequency. (When standard monitor display selection $F710$ is set to 0)
	RUH	The first basic parameter "RUH" (history function) is displayed.
	F \bar{n}	Turn the setting dial to select $F\bar{n}$.
	50.0	Operation frequency can be read by pressing the center of the setting dial.
	50.0	Turn the setting dial to adjust the meter. Note that the meter's indicator changes at this time, but the inverter's display (monitor) does not change. 
	50.0 \leftrightarrow F \bar{n}	Press the center of the setting dial to save the meter's calibrations. F \bar{n} and the frequency are displayed alternately.
	50.0	The display returns to its original indications. (When standard monitor display selection $F710$ is set to 0 [Operation frequency])

■ Adjusting the meter in inverter stop state

- Adjustment of output current ($F\bar{n}5L = 1$)

If, when adjusting the meter for output current, there are large fluctuations in data during adjustment, making adjustment difficult, the meter can be adjusted in inverter stop state.

When setting $F\bar{n}5L$ to 15 for fixed output 1 (output current 100% equivalent), a signal of absolute values will be output (inverter's rated current = 100%). In this state, adjust the meter with the $F\bar{n}$ (Meter adjustment) parameter.

Similarly, if you set $F\bar{n}5L$ to 16 for fixed output 2 (output current 50% equivalent), a signal that is sent out when half the inverter's rated current is flowing will be output through the FM terminal.

After meter adjustment is ended, set $F\bar{n}5L$ to 1 (output current).

- Other adjustments ($FNSL = 0, 2$ to $14, 18, 20, 21, 23$ to 25)

$FNSL = 17$: When fixed output 3 (other than the output current) is set, a signal of the value for other monitors is fixed at the following values and output through the FM terminal.

100% standard value for each item is the following:

$FNSL = 0, 2, 12, 23$: Maximum frequency (FH)
$FNSL = 3, 4$: 1.5 times of rated voltage
$FNSL = 7$: 2.5 times of rated torque
$FNSL = 9$ to 11	: Rated load factor
$FNSL = 13, 14, 20, 21$: Maximum input value (10V, or 20mA)
$FNSL = 18$: Maximum value (100.0%)
$FNSL = 24, 25$: $1000 \times F749$

3.5 Setting the electronic thermal

- RUL*** : Overload characteristic selection
- THR*** : Motor electronic-thermal protection level 1
- OLN*** : Electronic-thermal protection characteristic selection
- F173*** : Motor electronic-thermal protection level 2
- F607*** : Motor 150% overload detection time
- F631*** : Inverter overload detection method
- F632*** : Electronic-thermal memory
- F657*** : Overload alarm level

- Function

This parameter allows selection of the appropriate electronic thermal protection characteristics according to the particular rating and characteristics of the motor.

[Parameter setting]

Title	Function	Adjustment range				Default setting
<i>RUL</i>	Overload characteristic selection	0: - 1: Constant torque characteristic (150%-60s) 2: Variable torque characteristic (120%-60s)				0
<i>THR</i>	Motor electronic-thermal protection level 1	10 – 100 (%) / (A) *1				100
<i>OLN</i>	Electronic-thermal protection characteristic selection	Setting value		Overload protection	Overload stall	0
		0	Standard motor	valid	invalid	
		1		valid	valid	
		2		invalid	invalid	
		3		invalid	valid	
		4	VF motor (special motor)	valid	invalid	
		5		valid	valid	
		6		invalid	invalid	
7	invalid	valid				
<i>F173</i>	Motor electronic-thermal protection level 2	10 – 100 (%) / (A) *1				100
<i>F607</i>	Motor 150% overload detection time	10 – 2400 (s)				300
<i>F631</i>	Inverter overload detection method	0: 150%-60s (120%-60s) 1: Temperature estimation				0

[Parameter setting]

Title	Function	Adjustment range	Default setting
F 5 3 2	Electronic-thermal memory	0: Disabled 1: Enabled *2	0
F 5 5 7	Overload alarm level	10-100	50

*1: The inverter's rated current is 100%. When F 7 0 i (current and voltage unit selection) = 1 (A (amps)/V (volts)) is selected, it can be set at A (amps).

*2: F 5 3 2 = 1 : Electronic-thermal statuses (cumulative overload value) of motor and inverter are saved when power supply is OFF. It is calculated from the saved value when power supply is ON again.

3 1) Setting the electronic thermal protection characteristics selection **0 L n** and motor electronic thermal protection level 1 **EHr**, 2 **F 1 7**

The electronic thermal protection characteristics selection **0 L n** is used to enable or disable the motor overload trip function (**0 L 2**) and the overload stall function.

While the inverter overload trip (**0 L i**) will be in constantly detective operation, the motor overload trip (**0 L 2**) can be selected using the parameter **0 L n**.

Explanation of terms

Overload stall: This is an optimum function for equipment such as fans, pumps and blowers with variable torque characteristics that the load current decreases as the operating speed decreases.

When the inverter detects an overload, this function automatically lowers the output frequency before the motor overload trip **0 L 2** is activated. With this function, operation can be continued, without tripping, by operating using a frequency balanced by load current.

Note: Do not use the overload stall function with loads having constant torque characteristics (such as conveyor belts in which load current is fixed with no relation to speed).

[Using standard motors (other than motors intended for use with inverters)]

When a motor is used in the lower frequency range than the rated frequency, that will decrease the cooling effects for the motor. This speeds up the start of overload detection operations when a standard motor is used in order to prevent overheating.

■ Setting of electronic thermal protection characteristics selection $\overline{0} \overline{1} \overline{2}$

Setting value	Overload protection	Overload stall
$\overline{0}$	valid	invalid
$\overline{1}$	valid	valid
$\overline{2}$	invalid	invalid
$\overline{3}$	invalid	valid

■ Setting of motor electronic thermal protection level $\overline{1} \overline{\xi} \overline{H} \overline{r}$ (Same as $\overline{F} \overline{1} \overline{1} \overline{3}$)

When the capacity of the motor in use is smaller than the capacity of the inverter, or the rated current of the motor is smaller than the rated current of the inverter, adjust thermal protection level $\overline{1} \overline{\xi} \overline{H} \overline{r}$ for the motor in accordance with the motor's rated current.

* When displaying as a percentage, 100% = rated output current (A) of the inverter is displayed.

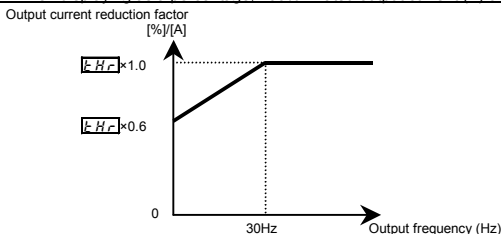

Note: The motor overload protection start level is fixed at 30Hz.

(Example of setting: When the VFMB1S-2007PL is running with a 0.4kW motor having 2A rated current)

Operation panel action	LED display	Operation
	$\overline{0} \overline{0}$	Displays the operation frequency. (Perform during operation stopped.) (When standard monitor display selection $\overline{F} \overline{7} \overline{1} \overline{0}$ is set to $\overline{0}$ [Operation frequency])
	$\overline{R} \overline{U} \overline{H}$	The first basic parameter " $\overline{R} \overline{U} \overline{H}$ " (history function) is displayed.
	$\overline{\xi} \overline{H} \overline{r}$	Turn the setting dial to change the parameter to $\overline{\xi} \overline{H} \overline{r}$.
	$\overline{1} \overline{0} \overline{0}$	Parameter values can be read by pressing the center of the setting dial (default setting is 100%).
	$\overline{4} \overline{8}$	Turn the setting dial to change the parameter to $\overline{4} \overline{8}$ (= motor rated current/inverter output rated current $\times 100 = 2.0/4.2 \times 100$)
	$\overline{4} \overline{8} \Rightarrow \overline{\xi} \overline{H} \overline{r}$	Press the center of the setting dial to save the changed parameter. $\overline{\xi} \overline{H} \overline{r}$ and the parameter are displayed alternately.

Note: The rated output current of the inverter should be calculated from the rated current for frequencies below 4kHz, regardless of the setting of the PWM carrier frequency parameter ($\overline{F} \overline{3} \overline{0} \overline{0}$).

[Using a VF motor (motor for use with inverter)]

■ Setting of electronic thermal protection characteristics selection **$\underline{0L7}$**

Setting value	Overload protection	Overload stall
4	valid	invalid
5	valid	valid
6	invalid	invalid
7	invalid	valid

VF motors (motors designed for use with inverters) can be used in frequency ranges lower than those for standard motors, but their cooling efficiency decreases at frequencies below 6Hz.

■ Setting of motor electronic thermal protection level 1 **$\underline{E}Hr$** (Same as **$\underline{E}173$**)

If the capacity of the motor is smaller than the capacity of the inverter, or the rated current of the motor is smaller than the rated current of the inverter, adjust the electronic thermal protection level 1 $\underline{E}Hr$ so that it fits the motor's rated current.

* If the indications are in percentages (%), then 100% equals the inverter's rated output current (A).

Output current reduction factor [%][A]

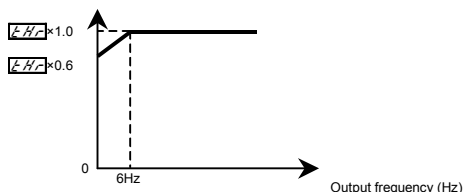

Note) The start level for motor overload reduction is fixed at 6 Hz.

2) Motor 150%-overload detection time **$\underline{F}607$**

Parameter **$\underline{F}607$** is used to set the time elapsed before the motor trips under a load of 150% (overload trip $\underline{0L2}$) within a range of 10 to 2400 seconds.

3) Inverter overload characteristics **$\underline{F}631$**

This function is set to protect the inverter unit. This function cannot be turned off by parameter setting.

The inverter has two overload detecting functions, which can be switched from one to another using parameter **$\underline{F}631$** (Inverter overload detection method).

[Parameter setting]

Title	Function	Adjustment range	Default setting
$\underline{F}631$	Inverter overload detection method	0: 150%-60s (120%-60s) 1: Temperature estimation	0

If the inverter overload trip function ($\underline{0L1}$) is activated frequently, this can be improved by adjusting the stall operation level **$\underline{F}607$** downward or increasing the acceleration time **$\underline{R}66$** or deceleration time **$\underline{d}E6$** .

■ $F_{\beta} \beta \neq 0$ (150%-60s), $R_{UL} = 1$ (Constant torque characteristic)

Protection is given uniformly regardless of ambient temperature, as shown by the 150%-60 sec overload curve in the figure below.

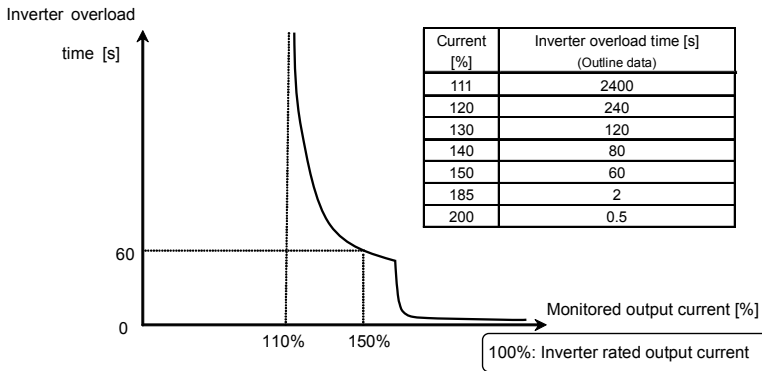

Inverter overload protection characteristics

■ $F_{\beta} \beta \neq 1$ (Temperature estimation), $R_{UL} = 1$ (Constant torque characteristic)

This parameter adjusts automatically overload protection, predicting the inverter internal temperature rise. (diagonally shaded area in the figure below)

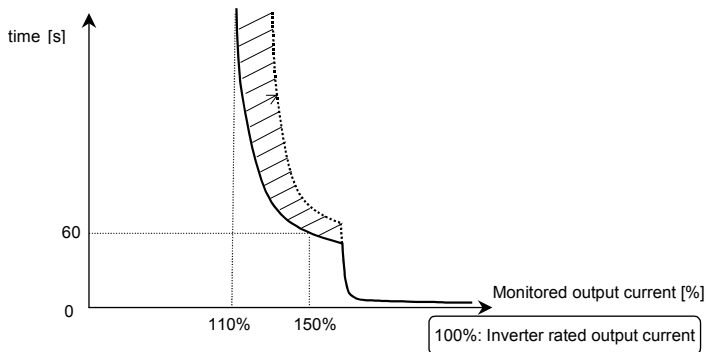

Inverter overload protection characteristics

Note 1: If the load applied to the inverter exceeds 150% of its rated load or the operation frequency is less than 0.1Hz, the inverter may trip (OL1 or OL2 to OL3) in a shorter time.

Note 2: The inverter is factory-set so that, if the inverter becomes overloaded, it will automatically reduce the carrier frequency to avoid an overload trip (OL1 or OL2 to OL3). A reduction in carrier frequency causes an increase in noise from the motor, but this does not affect the performance of the inverter.

If you do not want the inverter to reduce the carrier frequency automatically, set the parameter $F315=0$.

Note 3: Overload detection level is variable by condition of output frequency and carrier frequency.

Note 4: Regarding to characteristic for $RUL=2$ setting, refer to section 3.5.5).

4) Electronic thermal memory F632

When the power is OFF, it is possible to reset or maintain the overload totaling level.

This parameter's settings are applied both to the motor's electronic thermal memory and the electronic thermal memory for inverter protection.

[Parameters settings]

Title	Function	Adjustment range	Default setting
F632	Electronic thermal memory	0: Disabled 1: Enabled	0

☆ F632 = 1 is a function for complying with the U.S. NEC standards.

5) Overload characteristic selection **RUL**

Overload characteristic of inverter can be selected to 150%-60s or 120%-60s.

[Parameters settings]

Title	Function	Adjustment range	Default setting
RUL	Overload characteristic selection	0: - 1: Constant torque characteristic (150%-60s) 2: Variable torque characteristic (120%-60s)	0

☆ Regarding to characteristic for $RUL = 1$ setting, refer to section 3.5.3).

Note 1) In case of $RUL = 2$ setting, be sure to install the input AC reactor (ACL) between power supply and inverter.

■ $RUL = 2$ (Variable torque characteristic), $F53 = 0$ (120%-60s)

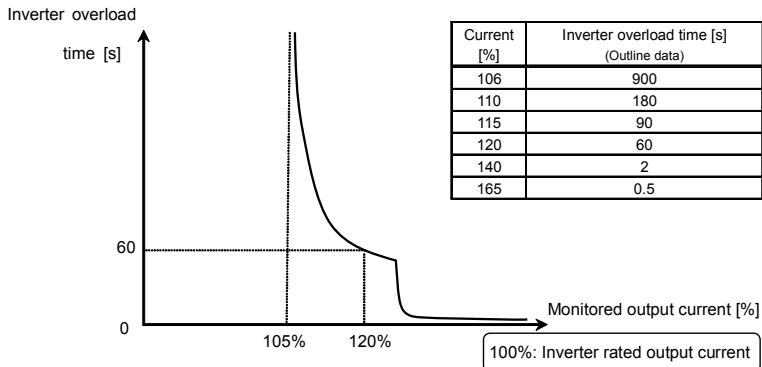

Inverter overload protection characteristic

■ $RUU = 2$ (Variable torque characteristic), $F631 = 1$ (Temperature estimation)

This parameter adjusts automatically overload protection, predicting the inverter internal temperature rise. (diagonally shaded area in the figure below)

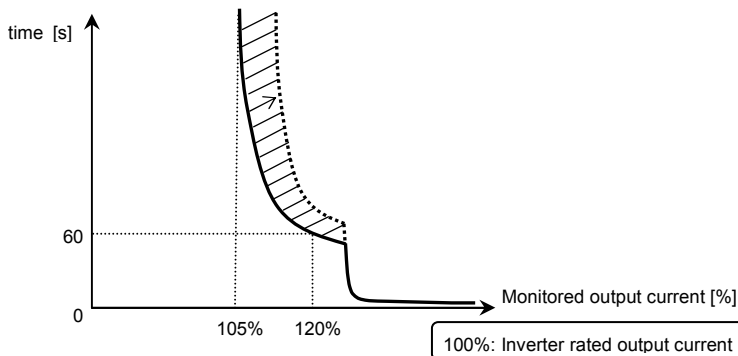

Inverter overload protection characteristics

Note 1: The rated output current of inverter is changed by setting of $RUU = 1$ or 2 .

Refer to page L-1 about each rated output current.

Note 2: Parameter RUU is displayed as "0" during reading after this is set.

Note 3: Present setting of inverter overload characteristic can be confirmed by status monitor.

Refer to monitor "Overload and region setting" of section 8.2.1.

6) Overload alarm level F657

When the motor overload level reaches to $F657$ setting value (%) of overload trip (OL2) level, output frequency monitor and "L" of left side digit are blinking on overload alarm status.

Overload alarm signal can be output.

[Parameters settings]

Title	Function	Adjustment range	Default setting
$F657$	Overload alarm level	10-100 (%)	50

[Example of setting] : Assigning the overload alarm to the S2 terminal.

Title	Function	Adjustment range	Setting
$F115$	Input terminal selection 5 (S2)	0-203	16: POL

17 is reverse signal.

3.6 Preset-speed operation (speeds in 15 steps)

$Sr1$ to $Sr7$: Preset-speed frequency 1 to 7

$F287$ to $F294$: Preset-speed frequency 8 to15

- Function
A maximum of 15 speed steps can be selected just by switching an external logic signal. Multi-speed frequencies can be programmed anywhere from the lower limit frequency L_L to the upper limit frequency U_L .

[Setting method]

1) Run/stop

The starting and stopping control is done from the terminal board.

Title	Function	Adjustment range	Setting
Cmd	Command mode selection	0: Terminal board 1: Panel keypad (including remote keypad) 2: RS485 communication 3: CANopen communication 4: Communication option	1

Note: When switching between preset-speed operation and other speed commands (analog signal, setting dial, communication, etc.), select the frequency setting mode at Cmd . → Refer to section 3) or 5.5

2) Preset-speed frequency setting

Set the speed (frequency) of the number of steps necessary.

[Parameter setting]

Setting from speed 1 to speed 7

Title	Function	Adjustment range	Default setting
$Sr1 - Sr7$	Preset-speed frequency 1-7	$L_L - U_L$ (Hz)	0.0

Setting from speed 8 to speed 15

Title	Function	Adjustment range	Default setting
$F287 - F294$	Preset-speed frequency 8-15	$L_L - U_L$ (Hz)	0.0

Preset-speed logic input signal example: Slide switch SW1 = SINK side

O: ON -: OFF (Speed commands other than preset-speed commands are valid when all are OFF)

Terminal	Preset-speed														
	1	2	3	4	5	6	7	8	9	10	11	12	13	14	15
S1-CC	○	-	○	-	○	-	○	-	○	-	○	-	○	-	○
S2-CC	-	○	○	-	-	○	○	-	-	○	○	-	-	○	○
S3-CC	-	-	-	○	○	○	○	-	-	-	-	○	○	○	○
RES-CC	-	-	-	-	-	-	-	○	○	○	○	○	○	○	○

★ Terminal functions are as follows.

Terminal S1Input terminal function selection 4A (S1)

$F \setminus i4 = i0$ (Preset-speed command 1: SS1)

Terminal S2Input terminal function selection 5 (S2)

$F \setminus i5 = i2$ (Preset-speed command 2: SS2)

Terminal S3Input terminal function selection 6 (S3)

$F \setminus i6 = i4$ (Preset-speed command 3: SS3)

Terminal RESInput terminal function selection 3A (RES)

$F \setminus i3 = i6$ (preset-speed command 4: SS4)

★ In the default settings, SS4 is not assigned. Assign SS4 to RES with input terminal function selection.

[Example of a connection diagram]
(with sink logic settings)

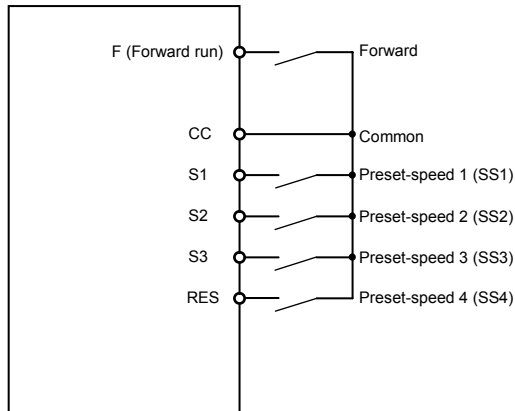

3) Using other speed commands with preset-speed command

Command mode selection <i>C P Q d</i>		0: Terminal board			1: Panel keypad (including remote keypad), 2: RS485 communication 3: CANopen communication 4: Communication option		
Frequency setting mode selection <i>F P Q d</i>		1: Terminal board VIA 2: Terminal board VIB 5: UP/DOWN from external logic input 8: Terminal board VIC 11: Pulse train input	0: Setting dial 1 (save even if power is off) 3: Setting dial 2 (press in center to save)	4: RS485 communication 6: CANopen communication 7: Communication option	1: Terminal board VIA 2: Terminal board VIB 5: UP/DOWN from external logic input 8: Terminal board VIC 11: Pulse train input	0: Setting dial 1 (save even if power is off) 3: Setting dial 2 (press in center to save)	4: RS485 communication 6: CANopen communication 7: Communication option
Preset-speed command	Active	Preset-speed command valid (Note)			Terminal command valid	Setting dial command valid	Communication command valid
	Inactive	Terminal command valid	Setting dial command valid	Communication command valid	(The inverter doesn't accept Preset-speed command.)		

3

Note) The preset-speed command is always given priority when other speed commands are input at the same time.

An example of three-speed operation with the default settings is shown below. (Frequency settings are required for *Sr 1* to *3*)

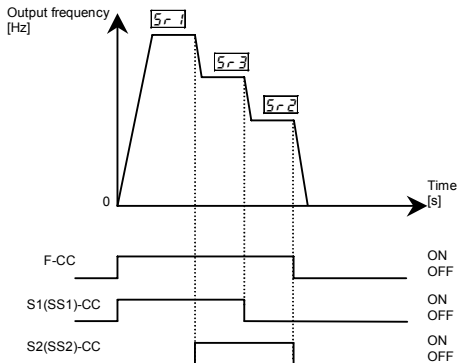

Example of 3-speed operation

4. Setting parameters

4.1 Setting and Display Modes

This inverter has the following three display modes.

Standard monitor mode

The standard inverter mode. This mode is enabled when inverter power goes on.

This mode is for monitoring the output frequency and setting the frequency reference value. It also displays information about status alarms during running and trips.

- Display of output frequency, etc.
 - $F \ 7 \ 1 \ 0$ Initial panel display selection
 - $(F \ 7 \ 2 \ 0)$ Initial remote keypad display selection
 - $F \ 7 \ 0 \ 2$ Free unit display scale
- Setting frequency reference values.
- Status alarm

If there is an error in the inverter, the alarm signal and the frequency will flash alternately in the LED display.

\overline{C} : When a current flows at or higher than the overcurrent stall prevention level.

P : When a voltage is generated at or higher than the over voltage stall prevention level.

\overline{L} : When the cumulative amount of overload reaches 50% or more of the overload trip value, or when the main circuit element temperature reaches the overload alarm level

H : When the overheat protection alarm level is reached

Setting monitor mode

The mode for setting inverter parameters.

⇒ How to set parameters, refer to section 4. 2.

There are two parameter read modes. Refer to section 4. 2 for details about selection and switching of modes.

Easy setting mode : Only the seven most frequently used parameters are displayed.
Parameters can be registered as necessary.
(max. 32 parameters)

Standard setting mode : Both basic and extended all parameters are displayed.

☆ Each press of the EASY key switches between the Easy setting mode and the Standard setting mode.

Status monitor mode

The mode for monitoring all inverter status.

Allows monitoring of set frequencies, output current/voltage and terminal information.

⇒ Refer to chapter 8.

The inverter can be moved through each of the modes by pressing the MODE key.

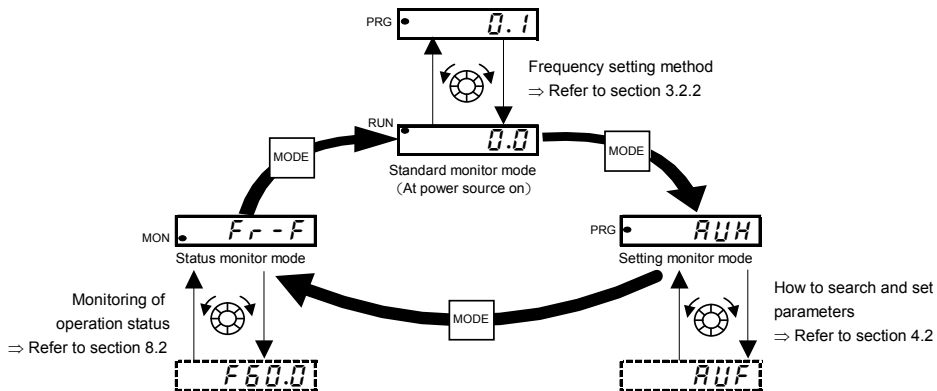

4.2 How to set parameters

There are two types of setting monitor modes: Easy mode and Standard setting mode. The mode active when power is turned on can be selected at *PSEL* (Registered parameter display selection), and the mode can be switched by the EASY key. Note, however, that the switching method differs when only the Easy mode is selected. Refer to section 4.5 for details.

Setting dial and panel key operations are as follows:



Turning the setting dial
Used to select items and incrementing/
decrementing values. Note)



Pressing the center of the setting dial
Used for executing operations and determining
values. Note)



Used to select the mode and return to
the previous menu



Used to switch between the Easy and Standard
setting modes.
Each press alternately switches between the two
modes in the standard monitor mode.

Easy setting mode

: The mode changes to the Easy setting mode when the EASY key is pressed at the standard monitor mode and "EASY" is displayed. In the Easy setting mode, the EASY lamp lights.

Only the most frequently used 7 basic parameters are displayed.
(standard default)

Easy setting mode

Title	Function
<i>CMO d</i>	Command mode selection
<i>FNO d</i>	Frequency setting mode selection
<i>ACC</i>	Acceleration time 1
<i>dEC</i>	Deceleration time 1
<i>tHr</i>	Motor overload protection level 1
<i>FN</i>	Meter adjustment
<i>PSEL</i>	Registered parameter display selection

☆ In the Easy setting mode, the EASY lamp lights.

☆ If the EASY key is pressed while the setting dial is being turned, values continue to be incremented or decremented even if you release your finger from the setting dial. This feature is handy when setting large values.

Note) Of the available parameters, number value parameters (*ACC* etc.) are reflected in actual operation when the setting dial is turned. Note, however, that the center of the setting dial must be pressed to save values even when the power is turned off.

Note, also, that item selection parameters (*FNO d* etc.) are not reflected in actual operation by just turning the setting dial. To reflect these parameters, press the center of the setting dial.

Standard setting mode

: The mode changes to the Standard setting mode when the EASY key is pressed and "5 E d" is displayed.
Both basic and extended all parameters are displayed.

Basic parameters

: This parameter is a basic parameter for the operation of the inverter.

⇒ Refer to chapter 5 for details.

⇒ Refer to chapter 11 for parameter tables.

Extended parameters

: The parameters for detailed and special setting.

⇒ Refer to chapter 6 for details.

⇒ Refer to chapter 11 for parameter tables.

For reasons of safety, the following parameters have been set up so that they cannot be reprogrammed while the inverter is running.

[Basic parameters]

<i>RVF</i>	(Guidance function)	<i>FN0d</i> *1	(Frequency setting mode selection)
<i>RUL</i>	(Overload characteristic selection)	<i>FH</i>	(Maximum frequency)
<i>RV1</i>	(Automatic acceleration/deceleration)	<i>PE</i>	(V/F control mode selection)
<i>RV2</i>	(Torque boost setting macro function)	<i>UP</i>	(Default setting)
<i>EN0d</i> *1	(Command mode selection)	<i>SEL</i>	(Checking the region setting)

[Extended parameters]

<i>F104</i> to <i>F156</i>	<i>F405</i> to <i>F417</i>
<i>F190</i> to <i>F199</i>	<i>F451</i>
<i>F207</i> / <i>F258</i> / <i>F261</i>	<i>F454</i> , <i>F458</i>
<i>F301</i> , <i>F302</i>	<i>F480</i> to <i>F495</i>
<i>F304</i> to <i>F316</i>	<i>F519</i> / <i>F603</i> / <i>F605</i> / <i>F608</i> / <i>F613</i>
<i>F319</i>	<i>F626</i> to <i>F631</i>
<i>F328</i> to <i>F330</i>	<i>F644</i> / <i>F669</i> / <i>F681</i> / <i>F750</i> / <i>F899</i>
<i>F340</i> , <i>F341</i>	<i>F909</i> to <i>F913</i>
<i>F346</i>	<i>F915</i> , <i>F916</i>
<i>F348</i> , <i>F349</i>	<i>F980</i>
<i>F360</i> / <i>F369</i>	<i>A900</i> to <i>A917</i>
<i>F375</i> to <i>F378</i>	<i>A973</i> to <i>A977</i>
<i>F389</i> / <i>F400</i>	

*1: *EN0d* and *FN0d* can be changed during operation by setting *F736*=0.

Note) Refer to "Communication manual" about parameter Cxxx.

4.2.1 Settings in the Easy setting mode

The inverter enters this mode by pressing the MODE key when the Easy setting mode is selected

When you are unsure of something during operation:
You can return to the Standard monitor mode by pressing the MODE key several times.

0.0
Standard monitor mode

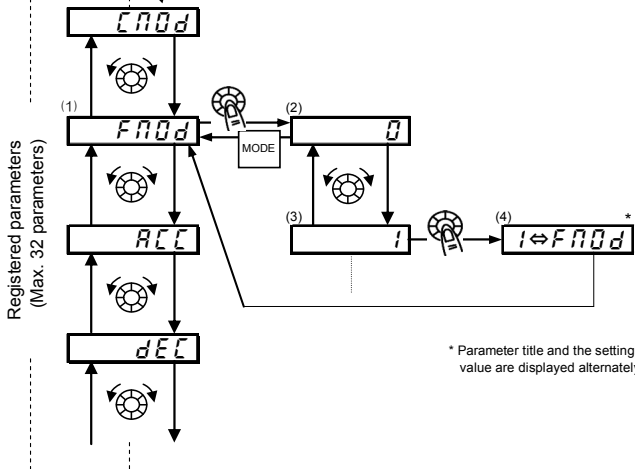

■ Setting parameters in the Easy setting mode

- (1) Selects parameter to be changed. (Turn the setting dial.)
- (2) Reads the programmed parameter setting. (Press the center of the setting dial.)
- (3) Change the parameter value. (Turn the setting dial.)
- (4) Press this key to save the change. (Press the center of the setting dial.)

☆ To switch to the Standard setting mode, press the EASY key in the Standard monitor mode. "5 & d" is displayed, and the mode is switched.

4.2.2 Settings in the Standard setting mode

The inverter enters this mode by pressing the MODE key when the Standard setting mode is selected.

When you are unsure of something during operation:
You can return to the Standard monitor mode by pressing the MODE key several times.

■ How to set basic parameters

- (1) Selects parameter to be changed. (Turn the setting dial.)
- (2) Reads the programmed parameter setting. (Press the center of the setting dial.)
- (3) Change the parameter value. (Turn the setting dial.)
- (4) Press this key to save the change. (Press the center of the setting dial.)

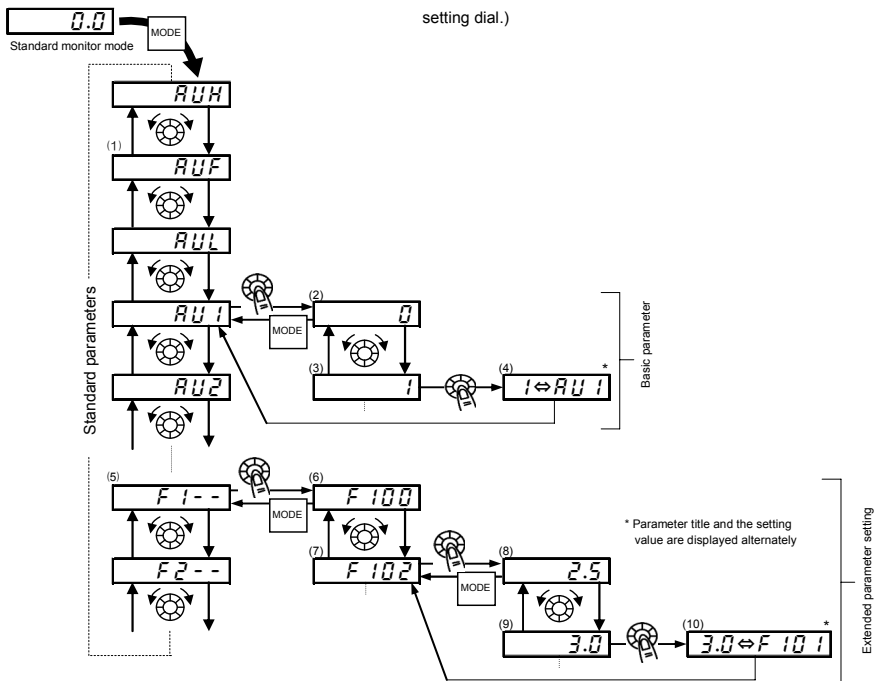

☆ To switch to the Easy setting mode, press the EASY key in the Standard monitor mode. *EASY* is displayed, and the mode is switched.

■ How to set extended parameters

Each extended parameter is composed of an "F", "R" or "L" suffixed with a 3-digit figure, so first select and read out the heading of the parameter you want "F 1 - -" to "F 9 - -", "R - - -", "L - - -" ("F 1 - -": Parameter starting point is 100, "R - - -": Parameter starting point is A.)

- (5) Select the title of the parameter you want to change. (Turn the setting dial.)
- (6) Press the Enter key to activate the selected parameter. (Press the center of the setting dial.)
- (7) Selects parameter to be changed. (Turn the setting dial.)
- (8) Reads the programmed parameter setting. (Press the center of the setting dial.)
- (9) Change the parameter value. (Turn the setting dial.)
- (10) Press this key to save the change. (Press the center of the setting dial.)

■ Adjustment range and display of parameters

H I: An attempt has been made to assign a value that is higher than the programmable range. (Note that the setting of the currently selected parameter may exceed the upper limit as a result of changing other parameters.)

L O: An attempt has been made to assign a value that is lower than the programmable range. (Note that the setting of the currently selected parameter may fall below the lower limit as a result of changing other parameters.)

If the above alarm is flashing on and off, values that exceed **H I** or are equal or lower than **L O** cannot be set.

4

4.3 Functions useful in searching for a parameter or changing a parameter setting

This section explains functions useful in searching for a parameter or changing a parameter setting. To use these functions, a parameter needs to be selected or set in advance.

Changed parameters history search (History function) **RUH**

This function automatically searches for the last five parameters whose settings have been changed. To use this function, select the **RUH** parameter. (Any changes are displayed regardless of whether or not they are the same as standard defaults.)

⇒ Refer to section 5.1 for details.

Set parameters by purpose (Guidance function) **RUF**

Only parameters required for a special purpose can be called up and set.

To use this function, select parameter **RUF**.

⇒ Refer to section 5.2 for details.

Reset parameters to default settings $\boxed{\text{EYP}}$

Use the EYP parameter to reset all parameters back to their default settings. To use this function, set parameter $\text{EYP}=\text{3}$ or 13 .

⇒ Refer to section 4.3.2 for details.

Call saved customer settings $\boxed{\text{EYP}}$

Customer settings can be batch-saved and batch-called.

These settings can be used as customer-exclusive default settings.

To use this function, set parameter $\text{EYP}=\text{7}$ or 8 .

⇒ Refer to section 4.3.2 for details.

Search changed parameters $\boxed{\text{Gru}}$

Automatically searches for only those parameters that are programmed with values different from the standard default setting. To use this function, select the Gru parameter.

⇒ Refer to section 4.3.1 for details.

4.3.1 Searching for and resetting changed parameters

$\boxed{\text{Gru}}$: Automatic edit function

• **Function**

Automatically searches for only those parameters that are programmed with values different from the standard default setting and displays them in the Gru . Parameter setting can also be changed within this group.









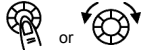

Note 1: If you reset a parameter to its factory default, the parameter will no longer appear in Gru .

Note 2: It may take several seconds to display changed parameters because all data stored in the user parameter group Gru is checked against the factory default settings. To cancel a parameter search, press the MODE key.

Note 3: Parameters which cannot be reset to the default setting after setting EYP to 3 are not displayed.

⇒ Refer to section 4.3.2 for details.

■ How to search and reprogram parameters

Panel operation	LED display	Operation
	<i>0.0</i>	Displays the operation frequency (operation stopped). (When standard monitor display selection is set as <i>F 7 1 0 = 0</i> (operation frequency))
	<i>R U H</i>	Displays the first basic parameter "History function (<i>R U H</i>)."
	<i>U r U</i>	Turn the setting dial, and select <i>U r U</i> .
	<i>U - -</i>	Press the center of the setting dial to enter the user parameter setting change search mode.
	<i>R C C</i>	Searches for and displays parameters different to the default settings. Parameters are changed by either pressing the center of the setting dial or turning it to the right. (Turning the setting dial to the left searches for parameter in the reverse direction.)
	<i>B.0</i>	Press the center of the setting dial to display set values.
	<i>S.0</i>	Turn the setting dial, and change set values.
	<i>S.0 ↔ R C C</i>	Press the center of the setting dial to set values. The parameter name and set value light alternately and are written.
	<i>U - - F</i> (<i>U - - r</i>)	Use the same steps as those above and turn the setting dial to display parameters to search for or whose settings must be changed, and check or change the parameter settings.
	<i>U r U</i>	When <i>U r U</i> appears again, the search is ended.
  	Parameter display ↓ <i>U r U</i> ↓ <i>F r - F</i> ↓ <i>0.0</i>	A search can be canceled by pressing the MODE key. Press the key once while the search is underway to return to the display of parameter setting mode. Pressing it while searching returns to the <i>U r U</i> display. After that you can press the MODE key to return to the status monitor mode or the standard monitor mode (display of operation frequency).

4.3.2 Return to default settings

Ⓔ 4 P : Default setting

- Function

It is possible to return groups of parameters to their defaults, clear run times, and record/recall set parameters.

[Parameter setting]

Title	Function	Adjustment range	Default setting
Ⓔ 4 P	Default setting	0: - 1: 50Hz default setting 2: 60Hz default setting 3: Default setting 1 (Initialization) 4: Trip record clear 5: Cumulative operation time clear 6: Initialization of type information 7: Save user setting parameters 8: Load user setting parameters 9: Cumulative fan operation time record clears 10, 11: - 12: Number of starting clear 13: Default setting 2 (complete initialization)	0

★ This function will be displayed as 0 during reading on the right. This previous setting is displayed.

Example: **Ⓔ 4 P**

★ Ⓔ 4 P cannot be set during the inverter operating. Always stop the inverter first and then program.

Programmed value

50 Hz default setting (Ⓔ 4 P= 1)

Setting Ⓔ 4 P to 1 sets the following parameters for base frequency 50 Hz use.

(The setting values of other parameters are not changed.)

- | | | | |
|---|--------------------------|---|--------|
| • Max. frequency (F H) | : 50Hz | • Upper limit frequency (UL) | : 50Hz |
| • Base frequency 1 (u L) | : 50Hz | • Base frequency 2 (F 1 7 0) | : 50Hz |
| • VIA input point 2 frequency (F 2 0 4) | : 50Hz | • VIB input point 2 frequency (F 2 1 3) | : 50Hz |
| • VIC input point 2 frequency (F 2 1 9) | : 50Hz | • Automatic light-load high-speed operation frequency (F 3 3 0) | : 50Hz |
| • Process upper limit (F 3 6 7) | : 50Hz | • Communication command point 2 frequency (F B 1 4) | : 50Hz |
| • Motor rated RPM (F 4 1 7) | : 1410 min ⁻¹ | | |

60 Hz default setting ($\text{tYP} = 2$)

Setting tYP to 2 sets the following parameters for base frequency 60 Hz use.

(The setting values of other parameters are not changed.)

- | | | | |
|--|--------------------------|--|--------|
| • Max. frequency (FH) | : 60Hz | • Upper limit frequency (UL) | : 60Hz |
| • Base frequency 1 (ωL) | : 60Hz | • Base frequency 2 ($F170$) | : 60Hz |
| • VIA input point 2 frequency ($F204$) | : 60Hz | • VIB input point 2 frequency ($F213$) | : 60Hz |
| • VIC input point 2 frequency ($F219$) | : 60Hz | • Automatic light-load high-speed operation frequency ($F330$) | : 60Hz |
| • Process upper limit ($F367$) | : 60Hz | • Communication command point 2 frequency ($F814$) | : 60Hz |
| • Motor rated RPM ($F417$) | : 1710 min ⁻¹ | | |

Default setting 1 ($\text{tYP} = 3$)

Setting tYP to 3 will return parameters to the standard values that were programmed at the factory.

- ☆ When 3 is set, $\overline{\text{trtl}}$ is displayed for a short time after the settings are configured, and then disappears. Then the inverter is in standard motor mode. In this case, the trip history data is cleared.

Be aware that the following parameters do not return to the standard factory settings even if $\text{tYP} = 3$ is set for maintainability. (To initialize all parameters, set $\text{tYP} = 13$.)

- | | |
|--|--|
| • $RU L$: Overload characteristic selection | • $F470 \sim F475$: VIA input bias / gain |
| • $F75L$: Meter selection | • $F669$: Logic output/pulse train output selection |
| • $F7$: Meter adjustment gain | • $F681$: Analog output signal selection |
| • $SE L$: Checking the region setting | • $F691$: Inclination characteristic of analog output |
| • $F107$: Analog input terminal selection | • $F692$: Analog output bias |
| • $F109$: Analog/logic input selection | • $F880$: Free notes |
| • $F127$: Sink/source switching | |

* : Refer to "Communication manual" about parameter Cxxx.

Trip record clear ($\text{tYP} = 4$)

Setting tYP to 4 initializes the past eight sets of recorded error history data.

- ☆ The parameter does not change.

Cumulative operation time clear ($\text{tYP} = 5$)

Setting tYP to 5 resets the cumulative operation time to the initial value (zero).

Initialization of type information ($\text{tYP} = 6$)

Setting tYP to 6 clears the trips when an $E \text{tYP}$ format error occurs. But if the $E \text{tYP}$ displayed, call us.

Save user setting parameters (t Y P = 7)

Setting t Y P to 7 saves the current settings of all parameters. (Refer to section 4.2.7)

Load user setting parameters (t Y P = 8)

Setting t Y P to 8 loads parameter settings to (calls up) those saved by setting t Y P to 7.
(Refer to section 4.2.7)

☆ By setting t Y P to 7 or 8, you can use parameters as your own default parameters.

Cumulative fan operation time record clear (t Y P = 9)

Setting t Y P to 9 resets the cumulative operation time to the initial value (zero).

Set this parameter when replacing the cooling fan, and so on

Number of starting clear (t Y P = 12)

Setting t Y P to 12 resets the number of starting to the initial value (zero).

Default setting 2 (t Y P = 13)

Set t Y P to 13 to return all parameters to their default settings.

When 13 is set, **in ik** is displayed for a short time after the settings are configured, and then disappears. Then setup menu 5 E t is displayed. After reviewing the setup menu items, make a setup menu selection. In this case, all parameters are returned to their defaults, and the trip history data is cleared. (Refer to section 3.1.)

4.4 Checking the region settings selection

5 E L: Checking the region setting

- Function

The region selected on the setup menu can be checked.

Also, the setup menu can be started to change to a different region.

[Parameter setting]

Title	Function	Adjustment range	Default setting
5 E L	Checking the region setting	0: Start setup menu 1: Japan (read only) 2: North America (read only) 3: Asia (read only) 4: Europe (read only)	*

* Default setting values vary depending on the setup menu setting. 1 to 4 are displayed.

■ Content of region settings

The number displayed when parameter 5 E L is read indicates which of the following regions was selected on the setup menu.

4: E U (Europe) is selected on the setup menu.

3: A S I A (Asia, Oceania) is selected on the setup menu.

2: U S A (North America) is selected on the setup menu.

1: J P (Japan) is selected on the setup menu.

The setup menu is started by writing 5 E L = 0.

Refer to section 3.1 for details.

Note: 1 to 4 set to parameter 5 E L are read-only. Be aware that they cannot be written.

4.5 EASY key function

PSEL : Registered parameters display selection

F751 to **F782** : Easy setting mode parameter 1 to 32

• **Function**

It is possible to switch between standard mode and easy setting mode using the EASY key.
Up to 32 arbitrary parameters can be registered to easy setting mode.

[Parameter setting]

Title	Function	Adjustment range	Default setting
PSEL	Registered parameters display selection	0: Standard setting mode at power on 1: Easy setting mode at power on 2: Easy setting mode only	0

It is possible to switch between standard mode and easy setting mode using the EASY key.
The way parameters are read out and displayed varies according to the mode selected.

Easy setting mode

Allows pre-registration (easy setting mode parameters) of frequently changed parameters and reading of only registered parameters (maximum of 32 types).

Standard setting mode

Standard setting mode in which all parameters are read out.

[How to read out parameters]

To enter the setting monitor mode, switch to the setting monitor mode using the EASY key, and then press the MODE key.

Turn the setting dial to read the parameter.

The relation between the parameter and the mode selected is shown below.

PSEL=0

* When the power is turned on, the inverter is in standard mode. Press the EASY key to switch to easy setting mode.

PSEL=1

* When the power is turned on, the inverter is in easy setting mode. Press the EASY key to switch to standard mode.

PSEL=2

* Always in easy setting mode.

[How to select parameters]

In easy setting mode, only parameters registered to parameters 1 to 32 are displayed in order of registration.
The values of the default settings are shown in the table below.

[Parameter setting]

Title	Function	Adjustment range	Default setting
F 75 1	Easy setting mode parameter 1	0-2999	3 (EN0d)
F 75 2	Easy setting mode parameter 2	0-2999	4 (FN0d)
F 75 3	Easy setting mode parameter 3	0-2999	9 (RCC)
F 75 4	Easy setting mode parameter 4	0-2999	10 (dEC)
F 75 5	Easy setting mode parameter 5	0-2999	600 (t Hr)
F 75 6	Easy setting mode parameter 6	0-2999	6 (Fn)
F 75 7	Easy setting mode parameter 7	0-2999 (Set by communication number)	999 (No function)
F 75 8	Easy setting mode parameter 8		
F 75 9	Easy setting mode parameter 9		
F 76 0	Easy setting mode parameter 10		
F 76 1	Easy setting mode parameter 11		
F 76 2	Easy setting mode parameter 12		
F 76 3	Easy setting mode parameter 13		
F 76 4	Easy setting mode parameter 14		
F 76 5	Easy setting mode parameter 15		
F 76 6	Easy setting mode parameter 16		
F 76 7	Easy setting mode parameter 17		
F 76 8	Easy setting mode parameter 18		
F 76 9	Easy setting mode parameter 19		
F 77 0	Easy setting mode parameter 20		
F 77 1	Easy setting mode parameter 21		
F 77 2	Easy setting mode parameter 22		
F 77 3	Easy setting mode parameter 23		
F 77 4	Easy setting mode parameter 24		
F 77 5	Easy setting mode parameter 25		
F 77 6	Easy setting mode parameter 26		
F 77 7	Easy setting mode parameter 27		
F 77 8	Easy setting mode parameter 28		
F 77 9	Easy setting mode parameter 29		
F 78 0	Easy setting mode parameter 30		
F 78 1	Easy setting mode parameter 31		
F 78 2	Easy setting mode parameter 32		

Note: If any number other than communication numbers is specified, it is regarded as 999 (no function assigned).

5. Main parameters

Before you operate the inverter, the parameters that you must first program are the basic parameters.

5.1 Searching for changes using the history function (R U H)

R U H : History function







History function (R U H):

Automatically searches for 5 latest parameters that are programmed with values different from the standard default setting and displays them in the R U H. Parameter setting can also be changed within this group R U H.

Notes on operation

- If no history information is stored, this parameter is skipped and the next parameter "R U F" is displayed.
- H E R d and E n d are added respectively to the first and last parameters in a history of changes.

How to use the history function

Operation panel action	LED display	Operation
	0.0	Displays the operation frequency (operation stopped). (When standard monitor display selection F 7 ! 0=0 [Operation frequency])
	R U H	The first basic parameter "R U H" (history function) is displayed.
	R C C	The parameter that was set or changed last is displayed.
	B.0	Press the center of the setting dial to display the set value.
	S.0	Turn the setting dial to change the set value.
	S.0 ↔ R C C	Press the center of the setting dial to save the changed value. The parameter name and the programmed value will flash on and off alternately.
	****	Turn the dial as described above to search for and display changed parameters to check and change the settings.
	H E R d (E n d)	H E R d: First historic record E n d: Last historic record

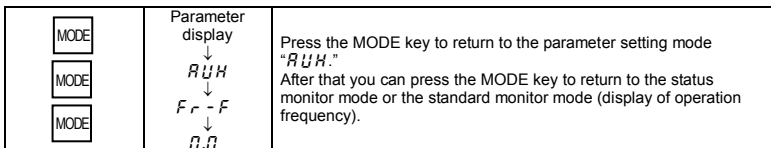

Note: The following parameters are not displayed in this *R U H*, even if they are the most recent changes.

F C (Operation frequency of operation panel),

R U F (Guidance function),

R U L (Overload characteristic selection),

R U I (Automatic acceleration/deceleration),

R U Q (Torque boost setting macro function),

t Y P (Default setting),

S E t (Checking the region setting),

F 7 0 0 (Prohibition of change of parameter settings)

F 7 3 7 (All key operation prohibition),

F 7 3 B (Password setting (*F 7 0 0*)),

F 7 3 9 (Password verification)

5.2 Setting a parameter using the guidance function (*R U F*)

R U F : Guidance function

Guidance function (*R U F*):

The guidance function refers to the special function of calling up only functions necessary to set up the inverter in response to the user's needs. When a purpose-specific guidance is selected, a group of parameters needed for the specified application (function) is formed and the inverter is switched automatically to the mode of setting the group of parameters selected. You can set up the inverter easily by simply setting the parameters in the group one after another. The guidance function (*R U F*) provides five purpose-specific guidance.











[Parameter setting]

Title	Function	Adjustment range	Default setting
<i>R U F</i>	Guidance function	0:- 1: - Note 1 2: Preset speed guidance 3: Analog signal operation guidance 4: Motor 1/2 switching operation guidance 5: Motor constant setting guidance	0

Note1) 1 is for manufacturer's settings. Do not change the settings.

■ How to use the guidance function

Here are the steps to follow to set parameters, using the guidance function. (When the Preset speed guidance $RUF = 2$)

Operation panel action	LED display	Operation
	0.0	Displays the operation frequency (operation stopped). (When standard monitor display selection $F7:0=0$ is set to 0 (operation frequency)).
	RUH	The first basic parameter "History (RUH)" is displayed.
	RUF	Turn the setting dial to select the guidance function (RUF).
	0	Press the center of the setting dial to display 0.
	2	Turn the setting dial to change to the purpose-specific guidance setting value "2".
	ENd	Press the center of the setting dial to display the purpose-specific parameter group (refer to following table).
	****	After moving to the purpose-specific guidance parameter group, use the setting dial to change the parameters.
	ENd	ENd is displayed on completion of the setting of the guidance parameter group.
  	Display of parameter ↓ RUF ↓ Fr - F ↓ 0.0	Press the MODE key to exit the guidance parameter group. By pressing the MODE key, you can return to the default monitoring mode (display of operation frequency).

If there is anything you do not understand during this operation, press the MODE key several times to start over from the step of RUH display.

HERd or ENd is affixed respectively to the first or last parameter in each guidance wizard parameter group.

Table of parameters that can be changed using the guidance function

Preset-speed setting guidance RUF=2	Analog input operation guidance RUF=3	Motor 2 switching operation guidance RUF=4	Motor constant setting guidance RUF=5
EN0d	EN0d	F111	Pe
FN0d	FN0d	F112	UL
ACC	ACC	F113	ULU
dEC	dEC	F114	F405
FH	FH	F115	F415
UL	UL	F116	F417
F111	LL	UL	F400
F112	F109	ULU	
F113	F216	ub	
F114	F217	F415	
F115	F218	EHr	
F116	F219	F601	
Sr1		ACC	
Sr2		dEC	
Sr3		F170	
Sr4		F171	
Sr5		F172	
Sr6		F173	
Sr7		F185	
F287		F500	
F288		F501	
F289			
F290			
F291			
F292			
F293			
F294			

5.3 Selecting inverter overload characteristic

FUL : Overload characteristic selection

Refer to section 3.5 for details.

5.4 Setting acceleration/deceleration time

\overline{RUI} : Automatic acceleration/deceleration

\overline{RCL} : Acceleration time 1

\overline{dEL} : Deceleration time 1

- Function
 - 1) For acceleration time 1 \overline{RCL} programs the time that it takes for the inverter output frequency to go from 0.0Hz to maximum frequency FH .
 - 2) For deceleration time 1 \overline{dEL} programs the time that it takes for the inverter output frequency to go from maximum frequency FH to 0.0Hz.

5.4.1 Automatic acceleration/deceleration

This automatically adjusts acceleration and deceleration time in line with load size.

\overline{RUI} = 1

* Adjusts the acceleration/deceleration time automatically within the range of 1/8 to 8 times as long as the time set with the \overline{RCL} or \overline{dEL} , depending on the current rating of the inverter.

\overline{RUI} = 2

* Automatically adjusts speed during acceleration only. During deceleration, speed is not adjusted automatically but reduced at the rate set with \overline{dEL} .

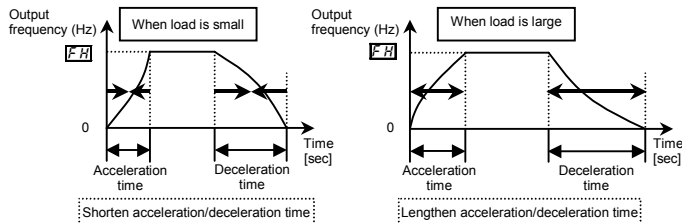

Set \overline{RUI} (automatic acceleration/deceleration) to 1 or 2.





[Parameter setting]

Title	Function	Adjustment range	Default setting
\overline{RUI}	Automatic acceleration/deceleration	0: Disabled (manual setting) 1: Automatic 2: Automatic (only at acceleration)	0

★ When automatically setting acceleration/deceleration time, always change the acceleration/deceleration time so that it conforms to the load. The acceleration/deceleration time changes constantly with load fluctuations. For inverters that require a fixed acceleration/deceleration time, use the manual settings (\overline{RCL} , \overline{dEL}).

- ★ Setting acceleration/deceleration time ($R\check{C}\check{C}$, $d\check{E}\check{C}$) in conformance with mean load allows optimum setting that conforms to further changes in load.
- ★ Use this parameter after actually connecting the motor.
- ★ When the inverter is used with a load that fluctuates considerably, it may fail to adjust the acceleration or deceleration time in time, and therefore may be tripped.
- ★ Do not use $R\check{U}i = i$ when using a dynamic braking resistor (optional).

[Methods of setting automatic acceleration/deceleration]

Operation panel action	LED display	Operation
	0.0	Displays the operation frequency. (When standard monitor display selection $F7i0$ is set to 0 [Operation frequency])
	$R\check{U}H$	The first basic parameter " $R\check{U}H$ " (history function) is displayed.
	$R\check{U}i$	Turn the setting dial to the right to change the parameter to $R\check{U}i$.
	0	Parameter values can be read by pressing the center of the setting dial.
	i	Turn the setting dial to the right to change the parameter to i or \check{C} .
	$i \rightarrow R\check{U}i$	Press the center of the setting dial to save the changed parameter. $R\check{U}i$ and the parameter are displayed alternately.

- ★ Assigning the forced deceleration command (function number 120 to 123) to any logic input terminal, it can be changed automatic deceleration on a mandatory.

5.4.2 Manually setting acceleration/deceleration time

Set acceleration time from 0.0 (Hz) operation frequency to maximum frequency FH and deceleration time as the time when operation frequency goes from maximum frequency FH to 0.0 (Hz).

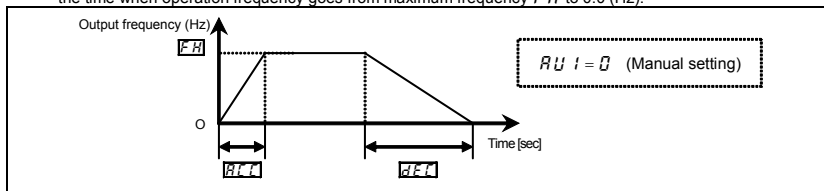

[Parameter setting]

Title	Function	Adjustment range	Default setting
$R\check{L}\check{C}$	Acceleration time 1	0.0-3600 (360.0) (s)	10.0
$d\check{E}\check{C}$	Deceleration time 1	0.0-3600 (360.0) (s)	10.0

Note1): When the acceleration/deceleration time is set to 0.0 seconds, the inverter accelerates and decelerates 0.05 seconds.

Note2): Setting increment unit can be changed to 0.01 seconds by parameter $F519$.

★ If the programmed value is shorter than the optimum acceleration/deceleration time determined by load conditions, overcurrent stall or overvoltage stall function may make the acceleration/deceleration time longer than the programmed time. If an even shorter acceleration/deceleration time is programmed, there may be an overcurrent trip or overvoltage trip for inverter protection. (Refer to section 13.1 for details)

5.5 Increasing starting torque

$RU2$: Torque boost setting macro function

- Function

Simultaneously switches inverter output (V/F) control and programs motor constants automatically (On-line automatic-tuning function) to improve torque generated by the motor. This parameter integrates the setting of special V/F control selection such as vector control.

[Parameter setting]

Title	Function	Adjustment range	Default setting
$RU2$	Torque boost setting macro function	0: Disabled 1: Automatic torque boost + auto-tuning 2: Vector control + auto-tuning 3: Energy saving + auto-tuning	0

Note1) Parameter displays on the right always return to 0 after setting. The previous setting is displayed on the left.

Ex. $\boxed{10}$

Note2) Auto-tuning is performed at the start of the motor.

Caution:

When the torque boost setting macro function $RU2$ is set, look at the motor's name plate and set the following parameters.

- UL : Base frequency 1 (rated frequency)
- ULV : Base frequency voltage 1 (rated voltage)
- $F405$: Motor rated capacity
- $F415$: Motor rated current
- $F417$: Motor rated speed

Set the other motor constants as necessary.

1) Increasing torque automatically according to the load

$RU2$ is set to 1 (Automatic torque boost + auto-tuning)

When torque boost setting macro function control $RU2$ is set to 1 (automatic torque boost + auto-tuning), the inverter keeps track of the load current in any speed range and automatically adjusts the output voltage to ensure enough torque and stable operation.

Note 1: The same characteristic can be obtained by setting the V/F control mode selection parameter P_{L} to 2 (automatic torque boost control) and the auto-tuning parameter F_{400} to 2 (auto-tuning).
 \Rightarrow Refer to section 6.21

Note 2: Setting R_{U2} to 1 automatically programs P_{L} to 2 .

2) When using vector control (increasing starting torque and high-precision operations)

R_{U2} is set to 2 (Vector control + auto-tuning)

Setting torque boost setting macro function control R_{U2} to 2 (vector control + auto-tuning) provides high starting torque bringing out the maximum in motor characteristics from the low-speed range. This suppresses changes in motor speed caused by fluctuations in load to provide high precision operation. This is an optimum feature for elevators and other load transporting machinery.

Note 3: The same characteristic can be obtained by setting the V/F control mode selection parameter P_{L} to 3 (vector control) and the auto-tuning parameter F_{400} to 2 (auto-tuning).
 \Rightarrow Refer to section 6.21

Note 4: Setting R_{U2} to 2 automatically programs P_{L} to 3 .

3) Energy-saving operation





R_{U2} is set to 3 (Energy saving + auto-tuning)

When torque boost setting macro function control R_{U2} is set to 3 (energy saving + auto-tuning), the inverter always passes a current appropriate to the load for energy saving.

Note 5: The same characteristic can be obtained by setting the V/F control mode selection parameter P_{L} to 4 (automatic energy saving) and the auto-tuning parameter F_{400} to 2 (auto-tuning).
 \Rightarrow Refer to section 6.21

Note 6: Setting R_{U2} to 3 automatically programs P_{L} to 3 .

[Example of parameter setting]

Operation panel action	LED display	Operation
	0.0	Displays the operation frequency. (Perform during operation stopped.) (When standard monitor display selection F_{710} is set to 0 (Operation frequency))
	R_{UH}	The first basic parameter " R_{UH} " (history function) is displayed.
	R_{U2}	Turn the setting dial to the right to change the parameter to R_{U2} (torque boost setting macro function).
	0.0	Parameter values can be read by pressing the center of the setting dial.
	0.3	Turn the setting dial to the right to change the parameter to 3 (energy saving + auto-tuning). (Right side is the setting value, left side is the history of the previous setting.)

	$0 \Rightarrow RU2$	Press the center of the setting dial to save the changed parameter. $RU2$ and the parameter are displayed alternately.
--	---------------------	--

If vector control cannot be programmed....

First read the precautions about vector control in section 5.12-9).

- 1) If the desired torque cannot be obtained \Rightarrow Refer to section 6.21 selection 2
- 2) If auto-tuning error "E t n !" appears \Rightarrow Refer to section 6.21 selection 4

■ $RU2$ (Torque boost setting macro function) and Pt (V/F control mode selection)

Automatic torque boost is the parameter for setting V/F control mode selection (Pt) and auto-tuning ($F400$) together. That is why all parameters related to change automatically when $RU2$ is changed.

		Automatically programmed parameters	
		Pt	$F400$
0	Displays 0 after resetting	-	Check the programmed value of Pt .
1	Automatic torque boost + auto-tuning	2	Automatic torque boost
2	Vector control + auto-tuning	3	Vector control
3	Energy saving + auto-tuning	4	Energy saving

5

4) Increasing torque manually (V/F constant control)

This is the setting of constant torque characteristics that are suited for such things as conveyors. It can also be used to manually increase starting torque.

If V/F constant control is programmed after changing $RU2$,

Set V/F control mode selection $Pt = 0$ (V/F constant).

\Rightarrow Refer to section 5.12.1)

Note 7: To further increase torque, increase the torque boost value $1(\nu b)$.

How to set the torque boost value $1(\nu b)$

\Rightarrow Refer to section 5.13

Note 8: V/F control selection $Pt = 1$ (variable torque) is an effective setting for load such as fans and pumps.

\Rightarrow Refer to section 5.12.2)

5.6 Selection of operation mode

cmd: Command mode selection

Fcmd: Frequency setting mode selection

- Function

These parameters are used to specify which input device (panel keypad, terminal board, or communication) takes priority in entering an operation stop command or frequency setting mode (terminal board VIA/VIB/VIC, setting dial, communication, or UP/DOWN from external logic).

<Command mode selection>

[Parameter setting]

Title	Function	Adjustment range	Default setting
cmd	Command mode selection	0: Terminal board 1: Panel keypad (including remote keypad) 2: RS485 communication 3: CANopen communication 4: Communication option	1

[Programmed value]

- 0**: Terminal board operation ON and OFF of an external signal run and stop operation.
- 1**: Panel keypad operation Press the **RUN** and **STOP** keys on the panel keypad to run and stop. Operation can also be done from the extension panel.
- 2**: RS485 communication Run/stop operations by RS485 communication from an external device. ⇒ Refer to section 6.33.
- 3**: CANopen communication Run/stop operations by CANopen communication from an external device. ⇒ Refer to section 6.33.
- 4**: Communication option Run/stop operations by commands from a communication option. ⇒ Refer to section 6.33.

* There are two types of function: the function that conforms to commands selected by **cmd**, and the function that conforms only to commands from the terminal board. (function number 108, 109) See the table of input terminal function selection in section 11.6.

* When priority is given to commands from a linked computer or terminal board, they have priority over the setting of **cmd**.

<Frequency setting mode selection>

[Parameter setting]

Title	Function	Adjustment range	Default setting
<i>F00d</i>	Frequency setting mode selection 1	0: Setting dial 1(save even if power is off) 1: Terminal board VIA 2: Terminal board VIB 3: Setting dial 2(press in center to save) 4: RS485 communication 5: UP/DOWN from external logic input 6: CANopen communication 7: Communication option 8: Terminal board VIC 9, 10: - 11: Pulse train input	0

[Programmed value]

- 0**: Setting dial 1 Frequencies are set by rotating the setting dial on the inverter. Like the position of notches in a volume knob, the frequency setting value at the position of the notch is saved.
⇒ Refer to section 3.2.2
- 1**: Terminal board VIA A frequency command is set by means of external analog signals. (VIA terminal: 0 – 10Vdc)
⇒ Refer to section 3.2.2 and 7.3
- 2**: Terminal board VIB A frequency command is set by means of external analog signals. (VIB terminal: 0 - +10Vdc or -10 - +10Vdc)
⇒ Refer to section 3.2.2 and 7.3
- 3**: Setting dial 2 Frequencies are set by rotating the setting dial on the inverter. Press the center of the setting dial to save the frequency setting value.
⇒ Refer to section 3.2.2
- 4**: RS485 communication Frequencies are set by RS485 communication from an external device.
⇒ Refer to section 6.33
- 5**: UP/DOWN frequency Frequencies are set by up/down commands from a terminal.
⇒ Refer to section 6.6.3
- 6**: CANopen communication Frequencies are set by CANopen communication from an external device.
⇒ Refer to section 6.33
- 7**: Communication option Frequencies are set by commands from a communication option.
⇒ Refer to section 6.33

- B**: Terminal board VIC A frequency command is set by means of external analog signals.
(VIC terminal: 0 (4) - 20mAdc)
⇒ Refer to section 3.2.2 and 7.3
- i i**: Pulse train input A frequency command is set by means of external pulse train signals.
(S2 terminal: 10pps - 20kpps)
⇒ Refer to section 6.6.5

- ★ No matter what value the command mode selection $\underline{C} \ \underline{N} \ \underline{O} \ \underline{d}$ and the frequency setting mode selection 1 $\underline{F} \ \underline{N} \ \underline{O} \ \underline{d}$ are set to the control input terminal functions described below are always in operative state.
 - Reset terminal (valid only for tripping if set for programmable input terminal function)
 - Standby terminal (when programmed by programmable input terminal functions).
 - External input tripping stop terminal command (when so set using the programmable input terminal function)
 - Coast stop command terminal (if set for programmable input terminal function)
- ★ To make changes in the command mode selection $\underline{C} \ \underline{N} \ \underline{O} \ \underline{d}$ and the frequency setting mode selection 1 $\underline{F} \ \underline{N} \ \underline{O} \ \underline{d}$, first stop the inverter temporarily.
(Can be changed while in operation when $\underline{F} \ \underline{7} \ \underline{3} \ \underline{G}$ is set to \underline{O} .)
- ★ Priority commands from communications or terminal boards are given priority over $\underline{F} \ \underline{N} \ \underline{O} \ \underline{d}$.

■ Preset-speed operation

$\underline{C} \ \underline{N} \ \underline{O} \ \underline{d}$: Set to \underline{O} (Terminal board operation)

$\underline{F} \ \underline{N} \ \underline{O} \ \underline{d}$: Valid in all setting values.

■ Input terminal settings

Assign the following functions to the input terminal to allow switching of the frequency command by turning the terminal ON/OFF.

Input terminal function		ON	OFF
48	Forced local from communication	Enabled during communication Local (Setting of $\underline{C} \ \underline{N} \ \underline{O} \ \underline{d}$, $\underline{F} \ \underline{N} \ \underline{O} \ \underline{d}$)	Communication
106	Frequency setting mode terminal board	Terminal board (VIA) enabled	setting of $\underline{F} \ \underline{N} \ \underline{O} \ \underline{d}$

Each of the following numbers (49, 107) are reverse signals.

■ Example of run and frequency command switching

Command mode and frequency setting mode switching

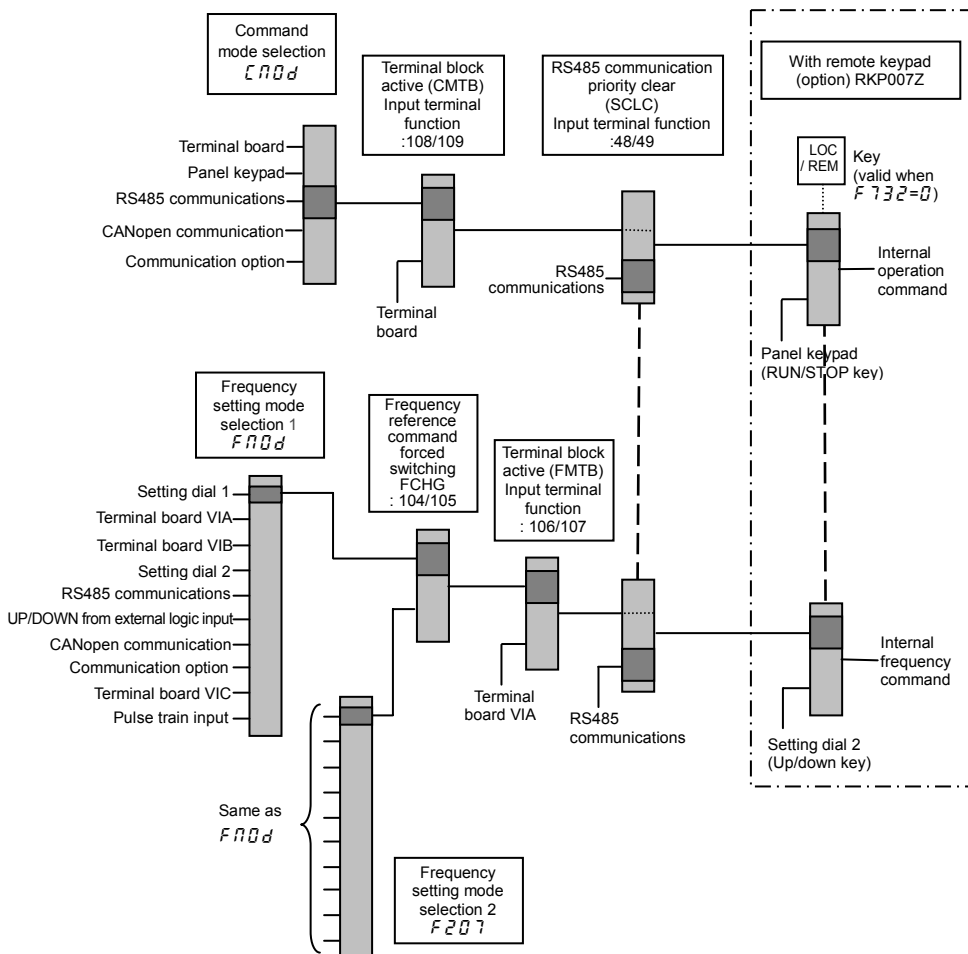

5.7 Meter setting and adjustment

FN5L: Meter selection

FN: Meter adjustment gain

Refer to section 3.4 for details.

5.8 Forward/reverse run selection (Panel keypad)

Fr: Forward/reverse run selection (Panel keypad)

- Function
Program the direction of rotation of the motor when the running and stopping are made using the RUN key and STOP key on the operation panel.
Valid when \overline{CND} (command mode) is set to 1 (operation panel).

[Parameter setting]

Title	Function	Adjustment range	Default setting
F_r	Forward/reverse run selection (Panel keypad)	0: Forward run 1: Reverse run 2: Forward run (F/R switching on remote keypad) 3: Reverse run (F/R switching on remote keypad)	0

- ★ Using remote keypad RKP007Z (option) : When F_r is set to 2 and the standard monitor is displayed, pressing the FWD/REV key changes the direction of rotation from reverse to forward after displaying the message $F_r - r$.
Pressing the FWD/REV key again changes the direction of rotation from reverse to forward after displaying the message $F_r - F$.
- ★ Using remote keypad RKP002Z (option) : When F_r is set to 2 and the standard monitor is displayed, pressing the DOWN key while pressing the ENT key changes the direction of rotation from reverse to forward after displaying the message $F_r - r$.
Pressing the UP key while pressing the ENT key again changes the direction of rotation from reverse to forward after displaying the message $F_r - F$.
- ★ Check the direction of rotation on the status monitor. Refer to section 8.1 for details about monitor.
 $F_r - F$: Forward run
 $F_r - r$: Reverse run
- ★ When the F and R terminals are used for switching between forward and reverse rotation from the terminal board, the F_r forward/reverse run selection parameter is rendered invalid.
Short across the F-CC or P24-F terminals: forward rotation
Short across the R-CC or P24-R terminals: reverse rotation

- ★ The inverter was factory-configured by default so that shorting terminals F-CC and terminals R-CC simultaneously would cause the motor to deceleration stop.
Using the parameter $F105$, however, you can select deceleration stop or reverse run.

5.9 Maximum frequency

FH : Maximum frequency

- Function
 - 1) Programs the range of frequencies output by the inverter (maximum output values).
 - 2) This frequency is used as the reference for acceleration/deceleration time.

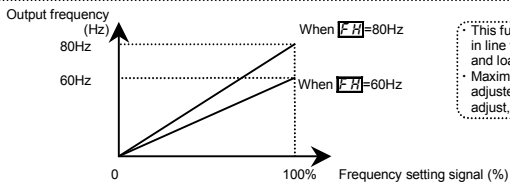

This function determines the value in line with the ratings of the motor and load.
Maximum frequency cannot be adjusted during operation. To adjust, first stop the inverter.

5

- ★ If FH is increased, adjust the upper limit frequency UL as necessary.

[Parameter setting]

Title	Function	Adjustment range	Default setting
FH	Maximum frequency	30.0-500.0 (Hz)	80.0

5.10 Upper limit and lower limit frequencies

\overline{UL} : Upper limit frequency

\overline{LL} : Lower limit frequency

- Function
Programs the lower limit frequency that determines the lower limit of the output frequency and the upper limit frequency that determines the upper limit of that frequency.

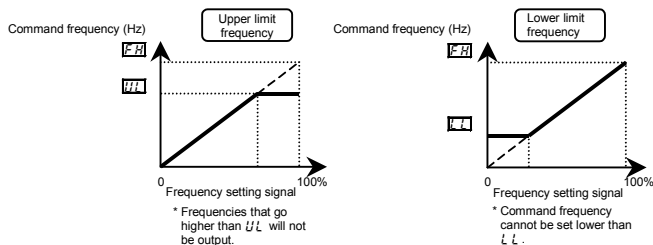

[Parameter setting]

Title	Function	Adjustment range	Default setting
\overline{UL}	Upper limit frequency	0.5 - FH (Hz)	*
\overline{LL}	Lower limit frequency	0.0 - \overline{UL} (Hz)	0.0

* Default setting values vary depending on the setup menu setting. Refer to section 11.5.

Note1) Do not set a value 10 times larger than ωL (base frequency 1) and $F170$ (base frequency 2) for \overline{UL} .

If a large number is set, the output frequency can only be output at 10 times of minimum value ωL and $F170$ and $R-05$ alarm is displayed.

Note2) Output frequency lower than parameter $F240$ (Starting frequency setting) is not output. Parameter $F240$ setting is needed.

5.11 Base frequency

$\underline{u\dot{L}}$: Base frequency 1

$\underline{u\dot{L}u}$: Base frequency voltage 1

- Function
Set the base frequency and the base frequency voltage in conformance with load specifications or the base frequency.

Note: This is an important parameter that determines the constant torque control area.

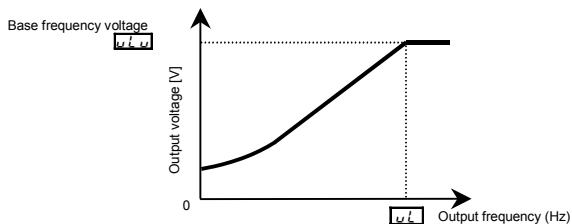

[Parameter setting]

Title	Function	Adjustment range	Default setting
$\underline{u\dot{L}}$	Base frequency 1	20.0-500.0 (Hz)	*
$\underline{u\dot{L}u}$	Base frequency voltage1	50-330 (240V class) 50-660 (500V class)	*

* Default setting values vary depending on the setup menu setting. Refer to section 11.5.

5.12 Selecting control mode

P₄: V/F control mode selection

- Function
 - The V/F controls shown below can be selected.
 - V/F constant
 - Variable torque
 - Automatic torque boost control (*1)
 - Vector control (*1)
 - Energy saving (*1)
 - Dynamic energy-saving (For fan and pump)
 - PM motor control
 - V/F 5-point setting
- (*1) Parameter setting macro torque boost: $R U \bar{2}$ parameter can automatically set this parameter and auto-tuning at a time.

[Parameter setting]

Title	Function	Adjustment range	Default setting
P ₄	V/F control mode selection	0: V/F constant 1: Variable torque 2: Automatic torque boost control 3: Vector control 4: Energy-saving 5: Dynamic energy-saving (For fan and pump) 6: PM motor control 7: V/F 5-point setting 8: - (*3)	(*2)

(*2): Default setting values vary depending on the setup menu setting. Refer to section 11.5.

(*3): 8 is manufacturer setting parameter. Do not change the value of this parameter.





Note: P₄ (V/F control mode selection) is valid only for the first motor.

Changes to "V/F constant control" when switching to the second motor, regardless of the P₄ setting.

Steps in setting are as follows

(In this example, the V/F control mode selection parameter P₄ is set to 3 (Vector control).)

[Setting V/F control mode selection to 3 (sensorless vector control)]

Operation panel action	LED display	Operation
	$\overline{0.0}$	Displays the operation frequency. (Perform during operation stopped.) (When standard monitor display selection $F 7 \ 1 \overline{0}$ is set to $\overline{0}$ [Operation frequency])
	$\overline{R U H}$	The first basic parameter " $\overline{R U H}$ " (history function) is displayed.
	$\overline{P \underline{L}}$	Rotate the setting dial to the right, and change the parameter to $\overline{P \underline{L}}$ (control selection).
	$\overline{0}$	Parameter values can be read by pressing the center of the setting dial (In case of $\overline{0}$).
	$\overline{3}$	Rotate the setting dial to the right, and change the parameter to $\overline{3}$ (vector control).
	$\overline{3} \leftrightarrow \overline{P \underline{L}}$	Press the center of the setting dial to save the changed parameter. $\overline{P \underline{L}}$ and parameter set value " $\overline{3}$ " are displayed alternately.

Caution:

When the V/F control mode selection $\overline{P \underline{L}}$ is set to $\overline{2}$: Automatic torque boost control, $\overline{3}$: Vector control, $\overline{4}$: Energy-saving, $\overline{5}$: Dynamic energy-saving, or $\overline{6}$: PM motor control, be sure to set the following parameters according to the motor's name plate.

- $\overline{u \underline{L}}$: Base frequency 1 (rated frequency)
- $\overline{u \underline{L} \ u}$: Base frequency voltage 1 (rated voltage)
- $\overline{F 4 \ \overline{0} \ 5}$: Motor rated capacity
- $\overline{F 4 \ \overline{1} \ 5}$: Motor rated current
- $\overline{F 4 \ \overline{1} \ 7}$: Motor rated speed

Set the other motor constants as necessary

5

1) Constant torque characteristics

Setting of V/F control mode selection $\overline{P \underline{L}}$ to $\overline{0}$ (V/F constant)

This is applied to loads with equipment like conveyors and cranes that require the same torque at low speeds as at rated speeds.

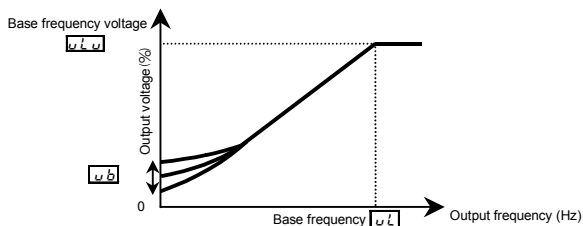

* To increase the torque further, increase the setting value of the manual torque boost value 1 (ωb).

⇒ Refer to section 5.12 for details.

2) Setting for fans and pumps

Setting of V/F control mode selection $P \xi$ to f (variable torque)

This is appropriate for load characteristics of such things as fans, pumps and blowers in which the torque in relation to load rotation speed is proportional to its square.

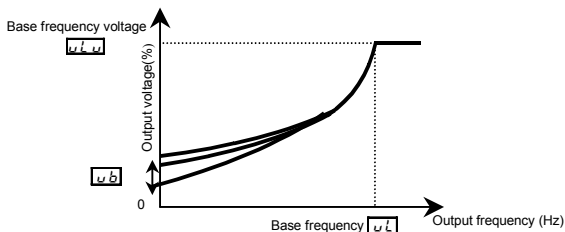

3) Increasing starting torque

Setting of V/F control mode selection $P \xi$ to ζ (automatic torque boost control)

Detects load current in all speed ranges and automatically adjusts voltage output (torque boost) from inverter. This gives steady torque for stable runs.

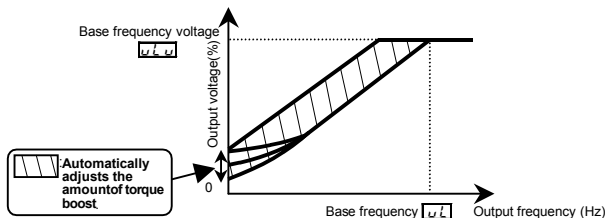

Note: This control system can oscillate and destabilize runs depending on the load. In this case, set V/F mode selection $P \xi = \square$ (V/F constant) and increase manual torque boost ωb .

★ Motor constant must be set

If the motor you are using is a 4P Toshiba standard motor and if it has the same capacity as the inverter, there is basically no need to set the motor constant. In any other case, set the following parameters according to the motor's name plate.

ωL (Base frequency 1), $\omega L v$ (Base frequency voltage 1), $F 4 0 5$ (Motor rated capacity), $F 4 1 5$ (Motor rated current), $F 4 1 7$ (Motor rated speed)

There are three procedures for setting the other motor constants.

- 1) Auto torque boost and a motor constant (auto-tuning) can be set at once.
To do so, set the basic parameter $R U 2$ to 1. ⇒ Refer to section 5.5 for details.
- 2) The motor constant can be automatically set (auto-tuning).
Set the extended parameter $F 4 0 0$ to 2. ⇒ Refer to section 6.21 selection 2 for details.
- 3) Each motor constant can be set individually. ⇒ Refer to section 6.21 selection 4 for details.

4) Vector control - increasing starting torque and achieving high-precision operation.

Setting of V/F control mode selection $P 1$ to 3 (Vector control)

Using sensorless vector control will provide the highest torque at the low speed ranges.

- (1) Provides large starting torque.
- (2) Effective when stable operation is required to move smoothly up from the low speeds.
- (3) Effective in elimination of load fluctuations caused by motor slippage.

★ Motor constant must be set

If the motor you are using is a 4P Toshiba standard motor and if it has the same capacity as the inverter, there is basically no need to set the motor constant. In any other case, set the following parameters according to the motor's name plate.

ωL (Base frequency 1), $\omega L v$ (Base frequency voltage 1), $F 4 0 5$ (Motor rated capacity), $F 4 1 5$ (Motor rated current), $F 4 1 7$ (Motor rated speed)

There are three procedures for setting the other motor constants.

- 1) The sensorless vector control and motor constants (auto-tuning) can be set at a time.
Set the basic parameter $R U 2$ to 2. ⇒ Refer to section 5.5 for details.
- 2) The motor constant can be automatically set (auto-tuning).
Set the extended parameter $F 4 0 0$ to 2. ⇒ Refer to section 6.21 selection 2 for details.
- 3) Each motor constant can be set individually. ⇒ Refer to section 6.21 selection 4 for details.

5) Energy-saving

Setting of V/F control mode selection $P 1$ to 4 (Energy-saving)
--

Energy can be saved in all speed areas by detecting load current and flowing the optimum current that fits the load.

★ Motor constant must be set

If the motor you are using is a 4P Toshiba standard motor and if it has the same capacity as the inverter, there is no need to set the motor constant. In any other case, set the following parameters according to the motor's name plate.

ωL (Base frequency 1), $\omega L \omega$ (Base frequency voltage 1), $F 4 \square \square$ (Motor rated capacity), $F 4 \square 5$ (Motor rated current), $F 4 \square 7$ (Motor rated speed)

There are three procedures for setting the other motor constants.

- 1) Automatic energy-saving operation and a motor constant can be set at once.
Set the basic parameter $R U \square$ to \square . \Rightarrow Refer to section 5.5 for details.
- 2) The motor constant can be automatically set (auto-tuning).
Set the extended parameter $F 4 \square \square$ to \square . \Rightarrow Refer to section 6.21 selection 2 for details.
- 3) Each motor constant can be set individually. \Rightarrow Refer to section 6.21 selection 4 for details.

6) Achieving further energy savings

Setting of V/F control mode selection $P \square$ to \square (Dynamic energy-saving)

More substantial energy savings than those provided by setting $P \square$ to \square can be achieved in any speed range by keeping track of the load current and passing a current appropriate to the load. The inverter cannot respond to rapid load fluctuations, so that this feature should be used only for loads, such as fans and pumps, that are free of violent load fluctuations.

★ Motor constant must be set

If the motor you are using is a 4P Toshiba standard motor and if it has the same capacity as the inverter, there is no need to set the motor constant. In any other case, set the following parameters according to the motor's name plate.

ωL (Base frequency 1), $\omega L \omega$ (Base frequency voltage 1), $F 4 \square \square$ (Motor rated capacity), $F 4 \square 5$ (Motor rated current), $F 4 \square 7$ (Motor rated speed)

There are three procedures for setting the other motor constants.

- 1) The motor constant can be automatically set (auto-tuning).
Set the extended parameter $F 4 \square \square$ to \square . \Rightarrow Refer to section 6.21 selection 2 for details.
- 2) Each motor constant can be set individually. \Rightarrow Refer to section 6.21 selection 4 for details.

7) Operating a permanent magnet motor

Setting of V/F control mode selection $P \square$ to \square (PM motor control)

Permanent magnet motors (PM motors) that are light, small in size and highly efficient, as compared to induction motors, can be operated in sensor-less operation mode.

Note that this feature can be used only for specific motors. For more information, contact your Toshiba dealer.

8) Setting of V/f characteristic arbitrarily

Setting of V/f control mode selection $P\grave{e}$ to 7 (V/f 5-point setting)

In this mode, the base frequency and the base frequency voltage for the V/f control need to be set to operate the motor while switching a maximum of 5 different V/f characteristics.

[Parameter setting]

Title	Function	Adjustment range	Default setting
F 190	V/f 5-point setting VF1 frequency	0.0~FH Hz	0.0
F 191	V/f 5-point setting VF1 voltage	0.0~100% *	0.0
F 192	V/f 5-point setting VF2 frequency	0.0~FH Hz	0.0
F 193	V/f 5-point setting VF2 voltage	0.0~100% *	0.0
F 194	V/f 5-point setting VF3 frequency	0.0~FH Hz	0.0
F 195	V/f 5-point setting VF3 voltage	0.0~100% *	0.0
F 196	V/f 5-point setting VF4 frequency	0.0~FH Hz	0.0
F 197	V/f 5-point setting VF4 voltage	0.0~100% *	0.0
F 198	V/f 5-point setting VF5 frequency	0.0~FH Hz	0.0
F 199	V/f 5-point setting VF5 voltage	0.0~100% *	0.0

* 100% adjustment value (200V class: 200V, 400V class: 400V)

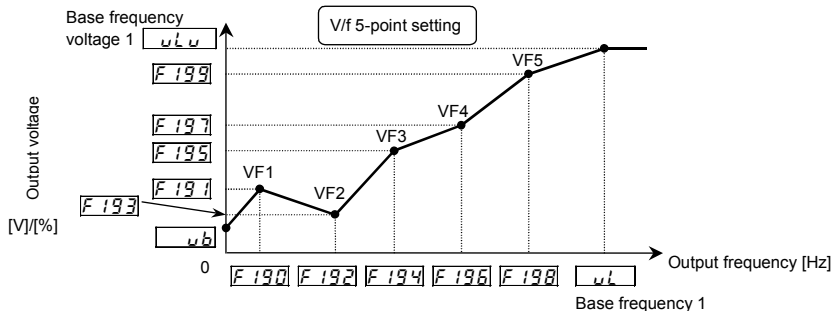

Note 1: Restrict the value of torque to boost (ωb) to 3% or so. Boosting the torque too much may impair the linearity between points.

Note 2: If the V/f 5-point is set within the diagonally shaded area in the figure below, the V/f 5-point is placed automatically on the boundary line (heavy line in the figure).

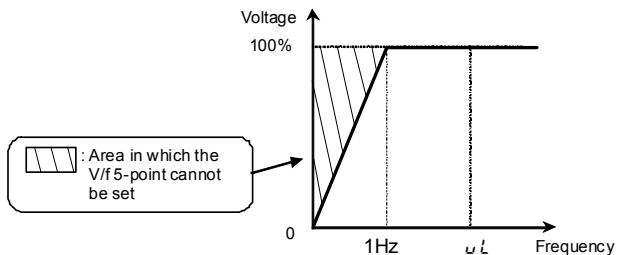

9) Cautions for vector control

- 1) When performing vector control, look at the motor's name plate and set the following parameters.
 ωL (Base frequency 1), $\omega L \omega$ (Base frequency voltage 1), $F 4 \text{ } \overline{5}$ (Motor rated capacity), $F 4 \text{ } \overline{5}$ (Motor rated current), $F 4 \text{ } \overline{7}$ (Motor rated speed)
- 2) The sensorless vector control exerts its characteristics effectively in frequency areas below the base frequency (ωL). The same characteristics will not be obtained in areas above the base frequency.
- 3) Set the base frequency to anywhere from 40 to 120Hz during vector control ($P \text{ } \overline{2}$).
- 4) Use a general purpose squirrel-cage motor with a capacity that is the same as the inverter's rated capacity or one rank below. The minimum applicable motor capacity is 0.1kW.
- 5) Use a motor that has 2-8 P.
- 6) Always operate the motor in single operation (one inverter to one motor). Sensorless vector control cannot be used when one inverter is operated with more than one motor.
 When using a combination of several motors, set the V/F constant ($P \text{ } \overline{7}$).
- 7) The maximum length of wires between the inverter and motor is 30 meters. If the wires are longer than 30 meters, set standard auto-tuning with the wires connected to improve low-speed torque during sensorless vector control.
 However the effects of voltage drop cause motor-generated torque in the vicinity of rated frequency to be somewhat lower.
- 8) When a reactor is connected between the inverter and a motor, the motor's generated torque may fall.
 Setting auto-tuning may also cause a trip ($E \text{ } \overline{n} \text{ } \overline{1}$) rendering sensorless vector control unusable.

5.13 Manual torque boost - increasing torque boost at low speeds

ub: Torque boost value 1

- Function
If torque is inadequate at low speeds, increase torque by raising the torque boost rate with this parameter.

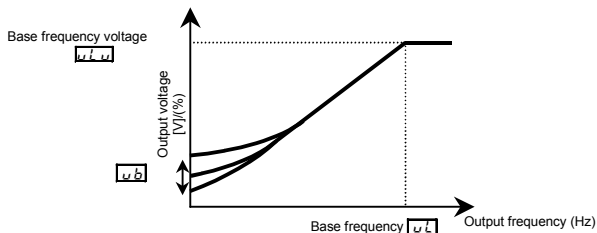

[Parameter setting]

Title	Function	Adjustment range	Default setting
ub	Torque boost value 1	0.0 - 30.0 (%)	According to model (Refer to section 11.4)

★ Valid when $P\ell$ is set to 0, 1, or 7.

Note 1: The optimum value is programmed for each inverter capacity. Be careful not to increase the torque boost rate too much because it could cause an overcurrent trip at startup.

5.14 Setting the electronic thermal

EHr: Motor electronic-thermal protection level 1

QLN: Electronic thermal protection characteristic selection

Refer to section 3.5 for details

5.15 Preset-speed operation (speeds in 15 steps)

Fr1 to **Fr7**, **F287** to **F294**: Preset-speed frequency 1 to 15

Refer to section 3.6 for details.

5.16 Process input value of PID control

FPId: Process input value of PID control

Refer to section 6.20 for details.

5.17 Standard default setting

ESP: Default setting

Refer to section 4.3.2 for details.

5

5.18 Checking the region setting selection

SET: Checking the region setting

Refer to section 4.4 for details.

5.19 Registered parameters display selection

PSEL: Registered parameters display selection

Refer to section 4.5 for details.

5.20 Searching for and resetting changed parameters

EDU: Automatic edit function

Refer to section 4.3.1 for details.

6. Other parameters

Extended parameters are provided for sophisticated operation, fine adjustment and other special purposes. Modify parameter settings as required. Refer to section 11 tables of extended parameters.

6.1 Input/output parameters

6.1.1 Low-speed signal

F100: Low-speed signal output frequency

- **Function**
When the output frequency exceeds the setting of **F100** an ON signal will be generated. This signal can be used as an electromagnetic brake excitation/release signal. This signal can also be used as an operation signal when **F100** is set to 0.0Hz, because an ON signal is put out if the output frequency exceeds 0.0Hz.
★ Output from the open collector output terminal RY-RC. (Default)
Output FLA-FLB-FLC and OUT are possible depending on the parameter settings.

[Parameter setting]

Title	Function	Adjustment range	Default setting
F100	Low-speed signal output frequency	0.0 - F_H (Hz)	0.0

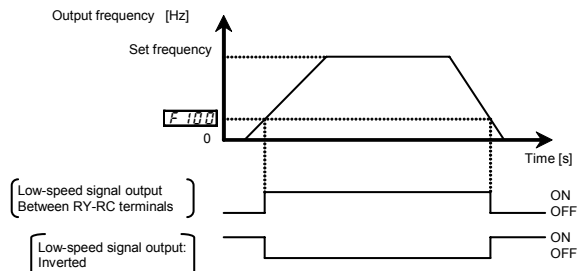

An example of the connection of the open collector OUT (sink logic)

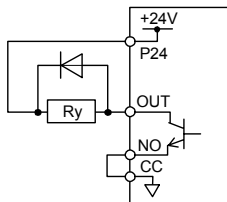

An example of the connection of the relay output terminals

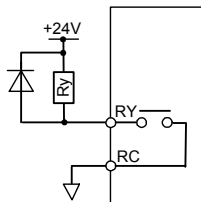

- Output terminal setting
Default outputs low-speed signal (ON signal) to RY-RC terminal. This setting must be changed to invert the polarity of the signal.

[Parameter setting]

Title	Function	Adjustment range	Default setting
$F\ 130$	Output terminal selection 1A (RY-RC)	0-255 (Refer to section 11.7)	4: LOW (Low-speed detection signal)

Setting value 5 is reverse signal.

Note) Set $F\ 132$ to output to FLA-FLC-FLB terminals and $F\ 131$ to OUT terminal.

6.1.2 Output of designated frequency reach signal

$F\ 102$: Speed reach detection band

- Function
When the output frequency becomes equal to the setting by designated frequency $\pm F\ 102$, an ON or OFF signal is generated.

[Parameter setting]

■Parameter setting of designated frequency and detection band

Title	Function	Adjustment range	Default setting
$F\ 102$	Speed reach detection band	0.0-FH (Hz)	2.5

■Parameter setting of output terminal selection

Title	Function	Adjustment range	Default setting
$F\ 131$	Output terminal selection 2A (OUT)	0-255 (Refer to section 11.7.)	6: RCH (Output frequency attainment signal (acceleration/deceleration completed))

Setting value 7 is reverse signal.

Note: Set $F\ 132$ to output to FLA-FLC-FLB terminals and $F\ 130$ to RY-RC terminal.

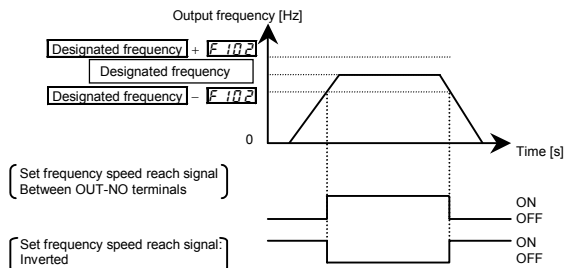

6.1.3 Output of set frequency speed reach signal

$F101$: Speed reach setting frequency

$F102$: Speed reach detection band

- Function
When the output frequency becomes equal to the frequency set by $F101 \pm F102$, an ON or OFF signal is generated.

[Parameter setting]

■Parameter setting of frequency and detection band

Title	Function	Adjustment range	Default setting
$F101$	Speed reach setting frequency	0.0- F_H (Hz)	0.0
$F102$	Speed reach detection band	0.0- F_H (Hz)	2.5

■Parameter setting of output terminal selection

Title	Function	Adjustment range	Setting
$F131$	Output terminal selection 2A (OUT)	0-255 (Refer to section 11.7.)	8: RCHF (Set frequency attainment signal)

Setting value 9 is reverse signal.

Note: Set $F132$ to output to FLA-FLC-FLB terminals and $F130$ to RY-RC terminal.

If the detection band value + the set frequency is less than the designated frequency

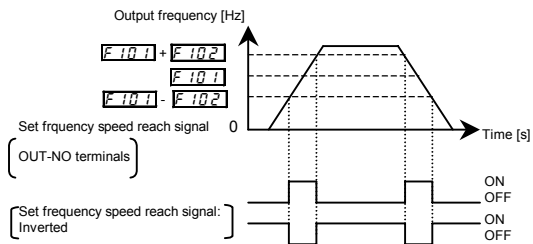

6.2 Input signal selection

6.2.1 Priority selection (Both F and R are ON)

F105: Priority selection (Both F and R are ON)

- Function
This parameter allows you to select the direction in which the motor runs when a forward run (F) command and a reverse run (R) command are entered simultaneously.
 - 1) Reverse
 - 2) Deceleration stop

[Parameter setting]

Title	Function	Adjustment range	Default setting
F105	Priority selection (Both F and R are ON)	0: Reverse 1: Deceleration stop	1

- (1) [F \bar{O} $S = \bar{O}$ (Reverse)]: If an F command and an R command are entered simultaneously, **the motor will run in the reverse direction.**

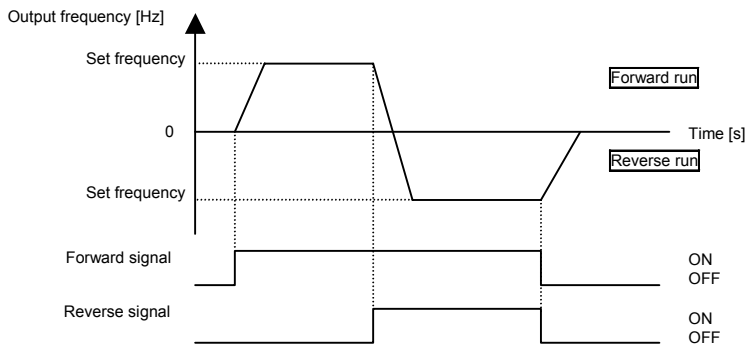

- (2) [F \bar{O} $S = I$ (Stop)]: If an F command and an R command are entered simultaneously, **the motor will deceleration stop.**

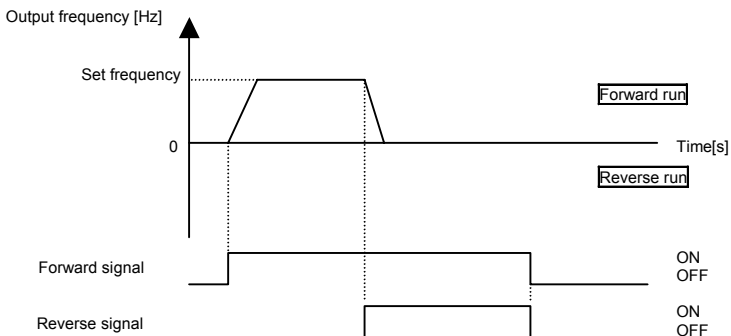

6.2.2 Changing the voltage range of VIB terminal

F107: Analog input terminal selection (VIB)

- Function
This parameter allows you to choose the voltage signal input for the VIB terminal.

[Parameter setting]

Title	Function	Adjustment range	Default setting
F107	Analog input terminal selection (VIB)	0: 0+10V 1: -10+10V	0

☆ F107=0: Input 0 to +10Vdc to VIB-CC terminals.

Resolution is maximum 1/1000 between 0 to +10Vdc.

☆ F107=1: Input -10 to +10Vdc to VIB-CC terminals.

Resolution is maximum 1/1000 between -10 to +10Vdc.

6.2.3 Changing the functions of VIA and VIB terminals

F109: Analog/logic input selection (VIA/VIB)

- Function
This parameter allows you to choose between signal input and contact signal input for the VIA and VIB terminals.

[Parameter setting]

Title	Function	Adjustment range	Default setting
F109	Analog/logic input selection (VIA/VIB)	0: Analog input for communications VIB - analog input 1: VIA - analog input VIB - contact input (Sink) 2: VIA - analog input VIB - contact input (Source) 3: VIA - contact input (Sink) VIB - contact input (Sink) 4: VIA - contact input (Source) VIB - contact input (Source)	0

Note) When using VIA and VIB terminals as contact input terminals, be sure to insert a resistor between P24 terminal and VIA/VIB terminals in sink logic connection, and insert a resistor between VIA/VIB terminals and CC terminal in source logic connection. (Recommended resistance: 4.7kΩ-1/2W)

6.3 Terminal function selection

6.3.1 Keeping an input terminal function always active (ON)

F104: Always active function selection 1

F108: Always active function selection 2

F110: Always active function selection 3

- Function
This parameter specifies an input terminal function that is always to be kept active (ON).

[Parameter setting]

Title	Function	Adjustment range	Default setting
F104	Always active function selection 1	0-153 (Refer to section 11.6.)	0 (No function)
F108	Always active function selection 2	0-153 (Refer to section 11.6.)	0 (No function)
F110	Always active function selection 3	0-153 (Refer to section 11.6.)	6 (ST)

- ★ Explanation of the coast stop function
When ST (Standby) is OFF, coast stops.
The default setting for ST (Standby) is ON, change the following settings.

- **F110=0** (no function)
- Assign open input terminal 6: ST (Standby).

Coast stops if terminal set for ST (Standby) is set to OFF. The monitor on the inverter at this time displays

0FF

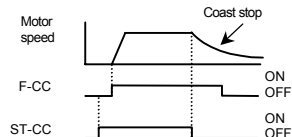

6.3.2 Modifying input terminal functions

F111: Input terminal selection 1A (F) **F151**: Input terminal selection 1B (F)

F112: Input terminal selection 2A (R) **F152**: Input terminal selection 2B (R)

F113: Input terminal selection 3A (RES) **F153**: Input terminal selection 3B (RES)

F114: Input terminal selection 4A (S1) **F154**: Input terminal selection 4B (S1)

F115: Input terminal selection 5 (S2) **F155**: Input terminal selection 1C (F)

F116: Input terminal selection 6 (S3) **F156**: Input terminal selection 2C (R)

F109: Analog/logic input selection (VIA/VIB):

F117: Input terminal selection 7 (VIB)

F118: Input terminal selection 8 (VIA)

⇒ Refer to section 7.2.1 for details about input terminal functions.

6.3.3 Modifying output terminal functions

F130: Output terminal selection 1A (RY-RC)

F131: Output terminal selection 2A (OUT)

F132: Output terminal selection 3 (FL)

F137: Output terminal selection 1B (RY-RC)

F138: Output terminal selection 2B (OUT)

F139: Output terminal logic selection (RY-RC, OUT)

⇒ Refer to section 7.2.2 for details about output terminal functions.

6.3.4 Comparing the frequency command values

F167: Frequency command agreement detection range

F00d: Frequency setting mode selection 1

F207: Frequency setting mode selection 2

- Function
If the frequency command value specified using **F00d** (or **F207**) almost agrees with the frequency command value from the VA terminal with an accuracy of \pm the setting of **F167**, an ON or OFF signal will be sent out.

■ Frequency command value and agreement detection range parameter setting

Title	Function	Adjustment range	Default setting
F167	Frequency command agreement detection range	0.0 ~ F_H (Hz)	2.5
F00d	Frequency setting mode selection 1	0: Setting dial 1(save even if power is off) 1: Terminal board VIA 2: Terminal board VIB 3: Setting dial 2(press in center to save) 4: RS485 communication 5: UP/DOWN from external logic input	0
F207	Frequency setting mode selection 2	6: CANopen communication 7: Communication option 8: Terminal board VIC 9, 10: - 11: Pulse train input	1

Note: To put out signals to RY-RC, OUT or FLA-FLB-FLC, set **F130**, **F131**, or **F132** respectively to 144 or 145

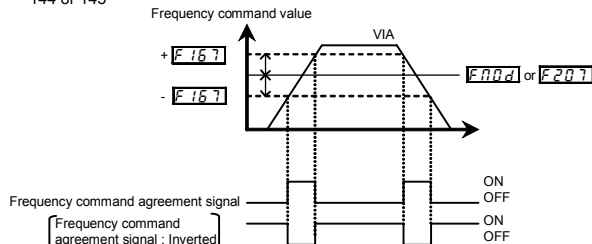

Note: This function can be used, for example, to send out a signal indicating whether the amount of processing and the amount of feedback agree with each other when the PID function is in use. For an explanation of the PID function, see section 6.20.

6.4 Basic parameters 2

6.4.1 Switching motor characteristics via terminal input

F170: Base frequency 2

F171: Base frequency voltage 2

F172: Torque boost value 2

F173: Motor electronic-thermal protection level 2

F185: Stall prevention level 2

- Function

Use the above parameters to switch the operation of two motors with a single inverter and to select motor V/F characteristics (two types) according to the particular needs or operation mode.

Note: The $P\bar{L}$ (V/F control mode selection) parameter is enabled only for motor1.
If motor 2 is selected, V/F control will be given constant torque characteristics.

[Parameter setting]

Title	Function	Adjustment range	Default setting
F170	Base frequency 2	20.0-500.0	*1
F171	Base frequency voltage 2	50-330 (V) (240V class) 50-660 (V) (500V class)	*1
F172	Torque boost value 2	0.0-30.0 (%)	Depending on model (Refer to section 11.4)
F173	Motor electronic-thermal protection level 2	10-100 (%) / (A) *2	100
F185	Stall prevention level 2	10-199 (%) / (A), 200 : Disabled *2	150

*1: Default setting values vary depending on the setup menu setting. Refer to section 11.5.

*2: The inverter's rated current is 100%. When $F70$ (current and voltage unit selection) = I (A (amps)/V (volts)) is set, it can be set at A (amps).

■ Setting of switching terminals

To switch to motor 2, assign the following functions to a terminal not being used. It is also possible to switch to acceleration/deceleration 2 (AD2). Refer to section 6.15.1 for details.

It is possible to set 3 functions for terminal F and R, and 2 functions for terminal S1 and S2.

Input terminal function number				Parameters changed from applicable parameters and default standards
24 AD2	26 AD3	28 VF2	32 OCS2	
OFF	OFF	OFF	OFF	Default setting : $Pt, uL, uLv, ub, tHr, RCC, dEC, F502, F601$
ON	OFF	OFF	OFF	$RCC \rightarrow F500, dEC \rightarrow F501, F502 \rightarrow F503$
OFF	ON	OFF	OFF	$RCC \rightarrow F510, dEC \rightarrow F511, F502 \rightarrow F512$
OFF	OFF	ON	OFF	During stop : $Pt \rightarrow V/F \text{ constant}, uL \rightarrow F170, uLv \rightarrow F171, ub \rightarrow F172, tHr \rightarrow F173$ During run : $uL \rightarrow F170, uLv \rightarrow F171, ub \rightarrow F172, tHr \rightarrow F173$
OFF	OFF	OFF	ON	$F601 \rightarrow F185$

Note 1: Each of the following numbers (25, 27, 29, 33) are reverse signals.

Note 2: Switching from "V/F constant" to $Pt = t$ to τ cannot be done while running. Stop the motor before changing.

Note 3: Integral value of motor electronic thermal is kept, after the motor switching.

■ Example of setting a terminal for switching : Sink logic

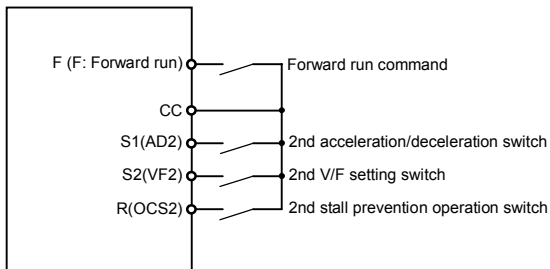

6.5 V/f 5-point setting

F190 : V/f5-point setting VF1 frequency

F191 : V/f 5-point setting VF1 voltage

F192 : V/f 5-point setting VF2 frequency

F193 : V/f 5-point setting VF2 voltage

F194 : V/f 5-point setting VF3 frequency

F195 : V/f 5-point setting VF3 voltage

F196 : V/f 5-point setting VF4 frequency

F197 : V/f 5-point setting VF4 voltage

F198 : V/f 5-point setting VF5 frequency

F199 : V/f 5-point setting VF5 voltage

⇒ For details, refer to 8) of section 5.12.

6.6 Frequency priority selection

6.6.1 Using a frequency command according to the particular situation

F00d : Frequency setting mode selection 1

F200 : Frequency priority selection

F207 : Frequency setting mode selection 2

- Function

These parameters are used to switch between two types of frequency command signals.

- Setting by parameters
- Switching by frequency
- Switching via terminal board input

Parameter setting

Title	Function	Adjustment range	Default setting
<i>F n 0 d</i>	Frequency setting mode selection 1	0: Setting dial 1(save even if power is off) 1: Terminal board VIA 2: Terminal board VIB 3: Setting dial 2(press in center to save) 4: RS485 communication 5: UP/DOWN from external logic input	0
<i>F 2 0 7</i>	Frequency setting mode selection 2	6: CANopen communication 7: Communication option 8: Terminal board VIC 9, 10: - 11: Pulse train input	1
<i>F 2 0 0</i>	Frequency priority selection	0: <i>F n 0 d</i> (Switchable to <i>F 2 0 7</i> by the input terminal) 1: <i>F n 0 d</i> (<i>F 2 0 7</i> for output frequencies equal to or lower than 1.0 Hz)	0

1) External switching (Input terminal function 104/105 : FCHG)

Frequency priority selection parameter *F 2 0 0* = 0

Switching between the command specified with *F n 0 d* and *F 2 0 7* can be made by entering a command from a terminal board.

To do so, however, the frequency command forced switching function (input terminal function selection: 104) needs to be set beforehand to an input terminal board.

If an OFF command is entered to the input terminal board: The command specified with *F n 0 d* will be selected.

If an ON command is entered to the input terminal board: The command specified with *F 2 0 7* will be selected.

Note) Input terminal function 105 is inverse.

2) Automatic switching by frequency command

Frequency priority selection parameter *F 2 0 0* = 1

The switching between the command specified with *F n 0 d* and *F 2 0 7* is done automatically according to the frequency command entered.

If the frequency set with *F n 0 d* is above 1Hz: The command specified with *F n 0 d* will be selected.

If the frequency set with *F n 0 d* is 1Hz or less: The command specified with *F 2 0 7* will be selected.

☆ Refer to the figure of "Example of run and frequency command switching" in section 5.6

6.6.2 Setting frequency command characteristics

F107: Analog input terminal selection(VIB)

F109: Analog/logic input selection (VIA/VIB)

F201: VIA input point 1 setting

F202: VIA Input point 1 frequency

F203: VIA Input point 2 setting

F204: VIA Input point 2 frequency

F209: Analog input filter

F210: VIB input point 1 setting

F211: VIB input point 1 frequency

F212: VIB input point 2 setting

F213: VIB input point 2 frequency

F216: VIC input point 1 setting

F217: VIC input point 1 frequency

F218: VIC input point 2 setting

F219: VIC input point 2 frequency

F810: Communication command point selection

F811: Communication command point 1 setting

F812: Communication command point 1 frequency

F813: Communication command point 2 setting

F814: Communication command point 2 frequency

- Function

Output frequency is adjusted in relation to frequency command according to external analog signals. VIA and VIB terminals are set to analog input.

F209 analog input filter is effective for eliminating noise from frequency setting circuit. Increase if operation cannot be done because noise effects stability.

★ To fine adjust the frequency command characteristics for analog input, use the parameters **F470** to **F475**. (Refer to section 6.6.4)

[Parameter setting]

Title	Function	Adjustment range	Default setting
<i>F 107</i>	Analog input terminal selection (VIB)	0: 0-+10V 1: -10-+10V	0
<i>F 109</i>	Analog/logic input selection (VIA/VIB)	0: Analog input for communications VIB - analog input 1: VIA - analog input VIB - contact input (Sink) 2: VIA - analog input VIB - contact input (Source) 3: VIA - contact input (Sink) VIB - contact input (Sink) 4: VIA - contact input (Source) VIB - contact input (Source)	0
<i>F 201</i>	VIA input point 1 setting	0-100 (%)	0
<i>F 202</i>	VIA input point 1 frequency	0.0-500.0 (Hz)	0.0
<i>F 203</i>	VIA input point 2 setting	0-100 (%)	100
<i>F 204</i>	VIA input point 2 frequency	0.0-500.0 (Hz)	*1
<i>F 209</i>	Analog input filter	2-1000 (ms)	64
<i>F 210</i>	VIB input point 1 setting	-100-+100 (%)	0
<i>F 211</i>	VIB input point 1 frequency	0.0-500.0 (Hz)	0.0
<i>F 212</i>	VIB input point 2 setting	-100-+100 (%)	100
<i>F 213</i>	VIB input point 2 frequency	0.0-500.0 (Hz)	*1
<i>F 216</i>	VIC input point 1 setting	0-100 (%)	0
<i>F 217</i>	VIC input point 1 frequency	0.0-500.0 (Hz)	0
<i>F 218</i>	VIC input point 2 setting	0-100 (%)	100
<i>F 219</i>	VIC input point 2 frequency	0.0-500.0 (Hz)	*1
<i>F 810</i>	Communication command point selection	0: Disabled 1: Enabled	0
<i>F 811</i>	Communication command point 1 setting	0-100 (%)	0
<i>F 812</i>	Communication command point 1 frequency	0.0- <i>F H</i> (Hz)	0
<i>F 813</i>	Communication command point 2 setting	0-100 (%)	100
<i>F 814</i>	Communication command point 2 frequency	0.0- <i>F H</i> (Hz)	*1

*1: Default setting values vary depending on the setup menu setting. Refer to section 11.5.

Note 1: Do not set point 1 and 2 to the same value. If they are set to the same value, *E r r i* is displayed.

1) 0-10Vdc voltage input adjustment (VIA, VIB terminals)

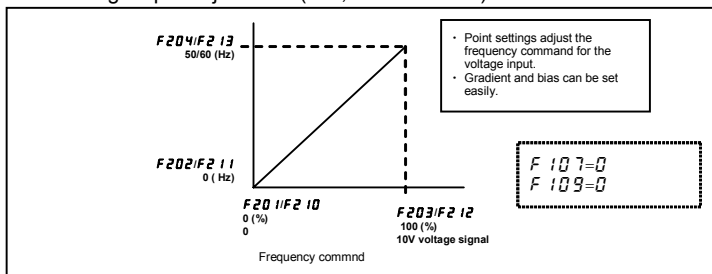

2) 4-20mA current input adjustment (VIC terminal)

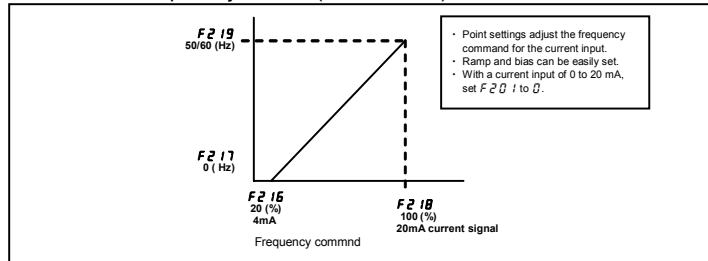

3) -10-+10 Vdc voltage input adjustment (VIB terminal)

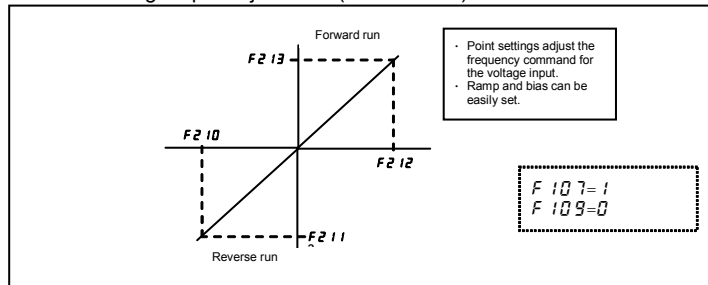

6.6.3 Setting of frequency with the input from an external logic

F264: External logic input - UP response time

F265: External logic input - UP frequency steps

F266: External logic input - DOWN response time

F267: External logic input - DOWN frequency steps

F268: Initial value of UP/DOWN frequency

F269: Change of the initial value of UP/DOWN frequency

- Function

These parameters are used to set an output frequency by means of a signal from an external device.

[Parameter setting]

Title	Function	Adjustment range	Default setting
F264	External logic input - UP response time	0.0 - 10.0 (s)	0.1
F265	External logic input - UP frequency steps	0.0 - FH (Hz)	0.1
F266	External logic input - DOWN response time	0.0 - 10.0 (s)	0.1
F267	External logic input - DOWN frequency steps	0.0 - FH (Hz)	0.1
F268	Initial value of UP/DOWN frequency	LL - UL (Hz)	0.0
F269	Change of the initial value of UP/DOWN frequency	0: Not changed 1: Setting of F268 changed when power is turned off	1

☆ This function is valid when the parameter FND (Frequency setting mode selection 1) = 5 is set.

Input terminal settings

Assign the following functions to the input terminal, you can change (up/down) or clear the output frequency by using the terminal's ON/OFF.

Input terminal function		ON	OFF
88	Frequency UP	Frequency setting increase	Clear
90	Frequency DOWN	Frequency setting decrease	Clear
92	Clear frequency UP/DOWN	OFF → ON: External logic up/down frequency clear settings	F268 settings

Each of the following numbers (89, 91, 93) are reverse signals.

■ Adjustment with continuous signals (Operation example 1)

Set parameters as follows to adjust the output frequency up or down in proportion to the frequency adjustment signal input time:

Panel frequency incremental gradient = $F255 / F254$ setting time

Panel frequency decremental gradient = $F267 / F266$ setting time

Set parameters as follows to adjust the output frequency up or down almost in synchronization with the adjustment by the panel frequency command:

$F254 = F266 = 1$

$(FHRLC) \geq (F255 / F254)$ setting time

$(FH/dEC) \geq (F267 / F266)$ setting time

<<Sample sequence diagram 1: Adjustment with continuous signals>>

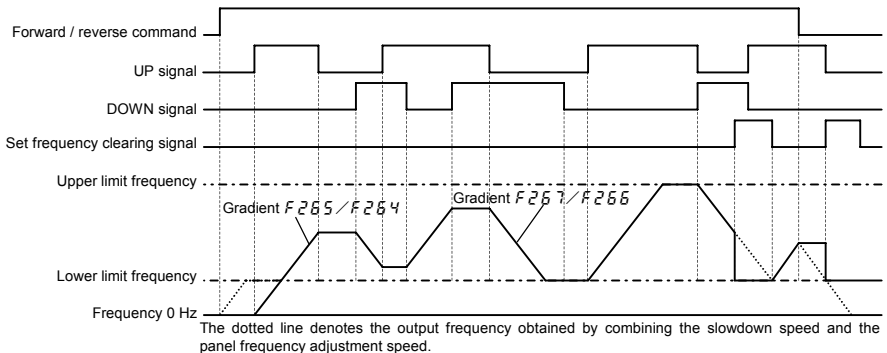

Note: If the operation frequency is set to the lower limit frequency, it will increase from 0Hz when power is turned on for the first time after the setting, and therefore the output frequency will not rise until the operation frequency reaches the lower limit frequency. (Operation at the lower limit frequency)

In this case, the time required for the operation frequency to reach the lower limit frequency can be shortened by setting $F2C$ to the lower limit frequency.

■ Adjustment with pulse signals (Operation example 2)

Set parameters as follows to adjust the frequency in steps of one pulse:

$F254, F266 \leq$ Pulse On time

$F255, F267 =$ Frequency obtained with each pulse

* The inverter does not respond to any pulses with an ON time shorter than that set with $F254$ or $F266$. 12ms or more of clearing signal is allowed.

<<Sample sequence diagram 2: Adjustment with pulse signals>>

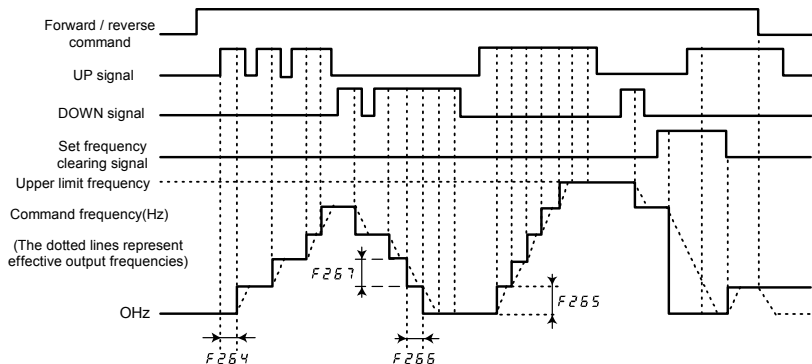

- If two signals are impressed simultaneously
 - If a clear single and an up or down signal are impressed simultaneously, priority will be given to the clear signal.
 - If up and down signals are impressed simultaneously, The frequency will change at the specified up or down rate.

- About the setting of the initial up/down frequency

To adjust the frequency starting at a specified frequency other than 0.0 Hz (default initial frequency) after turning on the inverter, specify the desired frequency using $F268$ (initial up/down frequency).

- About the change of the initial up/down frequency

To make the inverter automatically save the frequency immediately before it is turned off and start operation at that frequency next time power is turned on, set $F269$ (change of initial up/down frequency) to 1 (which changes the setting of $F268$ when power is turned off).
Keep in mind that the setting of $F268$ is changed each time power is turned off.

- Frequency adjustment range

The frequency can be set from 0.0Hz to FH (Maximum frequency). The lower-limit frequency will be set as soon as the set frequency clearing function (function number 92, 93) is entered from the input terminal.

- Minimum unit of frequency adjustment

If $F702$ (Frequency free unit magnification) is set to 1.00, the output frequency can be adjusted in steps of 0.01Hz.

6.6.4 Fine adjustment of frequency setting signal

F470: VIA input bias

F473: VIB input gain

F471: VIA input gain

F474: VIC input bias

F472: VIB input bias

F475: VIC input gain

- Function

These parameters are used to fine adjust the relation between the frequency setting signal input through the analog input terminal VIA, VIB, VIC and the output frequency.

Use these parameters to make fine adjustments after making rough adjustments using the parameters *F201* to *F204*, *F210* to *F213*, *F216* to *F219*

The figure below shows the characteristic of the frequency setting signal input through the VI terminal and that of the output frequency.

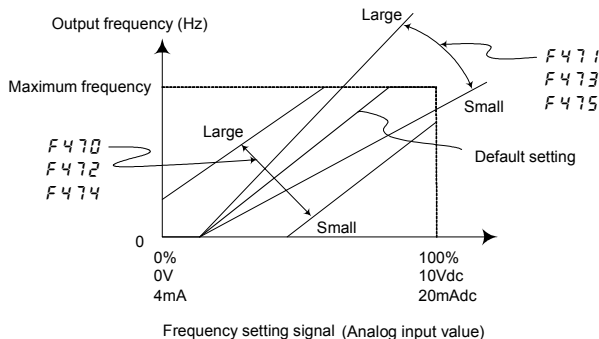

- * Bias adjustment of analog input terminal (*F470*, *F472*, *F474*)

To give leeway, the inverter is factory-adjusted by default so that it will not produce an output until a certain amount of voltage is applied to the analog input terminal. If you want to reduce the leeway, set this value to a larger value. Note that specifying a too large value may cause an output frequency to be output, even though the operation frequency is 0 (zero) Hz.

- * Gain adjustment of analog input terminal (*F471*, *F473*, *F475*)

The inverter is factory-adjusted by default so that the operation frequency can reach the maximum frequency, even though the voltage and current to the analog input terminal are below the maximum levels. If you want to adjust the inverter so that it will output the maximum frequency at the maximum voltage and current, set this value to a smaller value. Note that specifying a too small value may cause the operation frequency not to reach the maximum frequency, even though the maximum voltage and current are applied.

6.6.5 Setting of frequency with the pulse train input

F146: Logic input / pulse train input selection (S2)

F378: Number of pulse train input

F679: Pulse train input filter

- Function
These parameters are used to set an output frequency by means of pulse train input signal of S2 terminal.

[Parameter setting]

Title	Function	Adjustment range	Default setting
F146	Logic input / pulse train input selection (S2)	0: Logic input 1: Pulse train input	0
F378	Number of pulse train input	100-5000 (pps)	250
F679	Pulse train input filter	2-1000 (ms)	2

- ☆ This function is valid when the parameter $FND = 1$ (Pulse train input) and $F146 = 1$ (Pulse train input) are set.
- ☆ Number of pulses per 1Hz is set by parameter $F378$.
- ☆ Example of setting

$F378 = 250$ (pps) :	Input signal = 250 (pps)	⇒ Output frequency = 1.0 (Hz)
	Input signal = 1k (pps)	⇒ Output frequency = 4.0 (Hz)
	Input signal = 20k (pps)	⇒ Output frequency = 80.0 (Hz)
$F378 = 500$ (pps) :	Input signal = 500 (pps)	⇒ Output frequency = 1.0 (Hz)
	Input signal = 1k (pps)	⇒ Output frequency = 2.0 (Hz)
	Input signal = 20k (pps)	⇒ Output frequency = 40.0 (Hz)

Note) Minimum number of pulses to inputting S2 terminal is 10 pps, and Maximum is 20 kpps.

6.7 Operation frequency

6.7.1 Starting frequency

F240: Starting frequency setting

- Function

The frequency set with **F240** is put out as soon as operation is started. Use the **F240** parameter when a delay in response of starting torque according to the acceleration/deceleration time is probably affecting operation. Setting the starting frequency to a value from 0.5 to 3.0Hz is recommended. The occurrence of an overcurrent can be suppressed by setting this frequency below the rated slippage of the motor.

[Parameter setting]

Title	Function	Adjustment range	Default setting
F240	Starting frequency setting	0.1-10.0 (Hz)	0.5

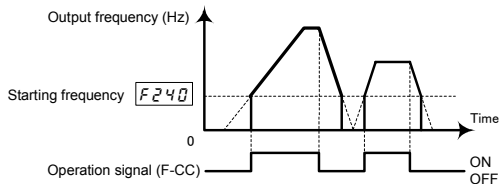

6.7.2 Run/stop control with frequency setting signals

F241: Operation starting frequency

F242: Operation starting frequency hysteresis

- Function
The Run/stop of operation can be controlled simply with frequency setting signals.

[Parameter setting]

Title	Function	Adjustment range	Default setting
F241	Operation starting frequency	0.0- F_H (Hz)	0.0
F242	Operation starting frequency hysteresis	0.0- F_H (Hz)	0.0

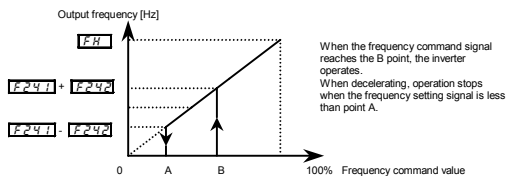

6.8 DC braking

6.8.1 DC braking

F249: PWM carrier frequency during DC braking

F250: DC braking starting frequency

F251: DC braking current

F252: DC braking time

- Function

A large braking torque can be obtained by applying a direct current to the motor. These parameters set the direct current to be applied to the motor, the application time and the starting frequency.

[Parameter setting]

Title	Function	Adjustment range	Default setting
F249	PWM carrier frequency during DC braking	2.0-16.0 (kHz)	4.0
F250	DC braking starting frequency	0.0- F_H (Hz)	0.0
F251	DC braking current	0.0-100 (%) / (A)	50
F252	DC braking time	0.0-25.5 (s)	1.0

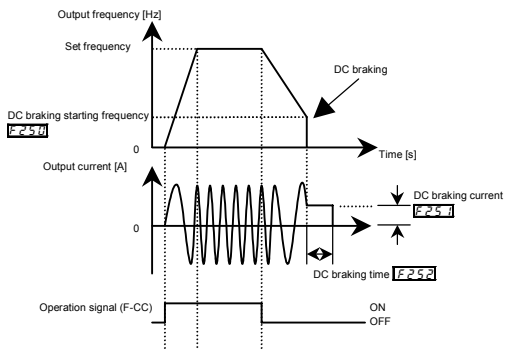

Note1: During DC braking, the overload protection sensitivity of the inverter increases. The DC braking current may be adjusted automatically to prevent tripping.

Note 2: During DC braking, the carrier frequency becomes the setting of parameter **F249** (PWM carrier frequency during DC braking).

Note 3: DC braking can be done by using terminal input. Input terminal 22: Assign DC braking command (23 is reverse). DC braking is applied while the terminal is ON, regardless of the **F250**, **F251** settings. Even if the terminal is OFF, DC braking is applied only for the **F252** time.

The amount of DC braking depends on the **F251** settings.

6.8.2 Motor shaft fixing control

F254: Motor shaft fixing control

- Function
This function is used to prevent the motor from running unexpectedly because its shaft is not restrained or to preheat the motor.

[Parameter setting]

Title	Function	Adjustment range	Default setting
F254	Motor shaft fixing control	0: Disabled, 1: Enabled	0

If the motor shaft fixing control **F254** is set to 1, half the braking force set with **F251** (DC braking rate) will be applied to the motor to continue DC braking even after the completion of ordinary DC braking. To stop motor shaft fixing control, turn off the standby command (ST signal).

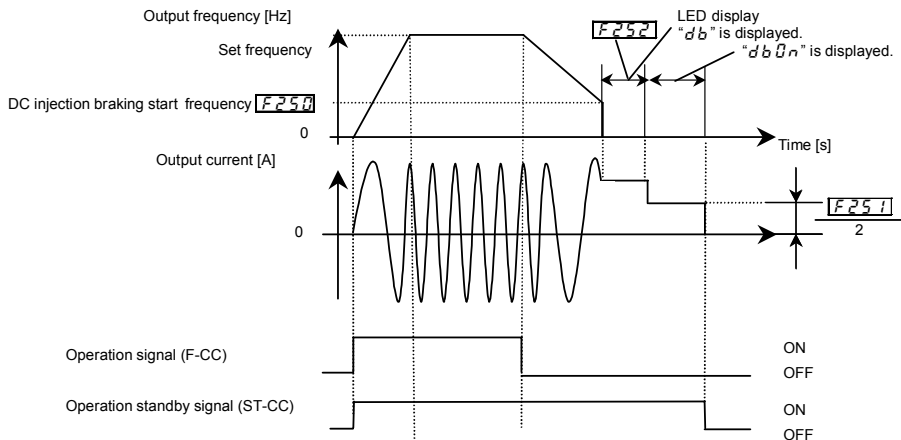

Note1: About the same motor shaft fixing control can be exercised by entering a DC braking command from external contacts.

Note2: If a power failure occurs during motor shaft fixing control and the motor starts to coast, motor shaft fixing control will be canceled.

Also, if the inverter trips during motor shaft fixing control and is restored to working order by the retry function, motor shaft fixing control will be canceled.

Note 3: During shaft fixing control, the carrier frequency is the setting of parameter **F249**.

6.9 Time limit for lower-limit frequency operation

6.9.1 Time limit for lower-limit frequency operation

F256: Time limit for lower-limit frequency operation

F391: Hysteresis for lower-limit frequency operation

- Function

If operation is carried out continuously at a frequency below the lower-limit frequency (LL) for the period of time set with $F256$, the inverter will automatically deceleration the motor to a stop. At that time, " LLP " is displayed (alternately) on the operation panel.

This function will be canceled if a frequency command above the lower-limit frequency ($LL + F391$) (Hz).

[Parameter setting]

Title	Function	Adjustment range	Default setting
$F256$	Time limit for lower-limit frequency operation	0.0: Disabled 0.1 - 600.0 (s)	0.0
$F391$	Hysteresis for lower-limit frequency operation	0.0- LL (Hz)	0.2

Output frequency [Hz]

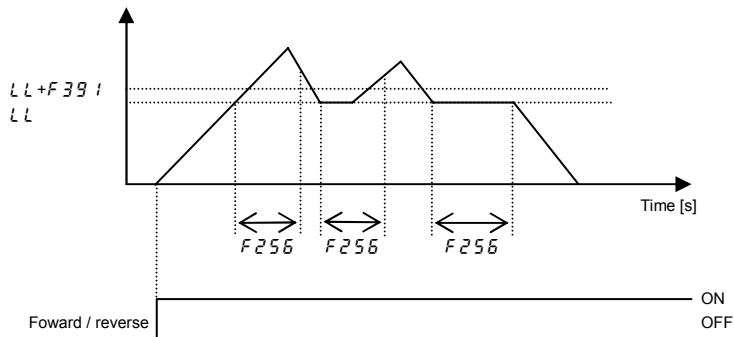

Note: This function is valid when doing forward/reverse switching.

When starting operation, does not operate until operation frequency reaches LL.

6.10 Jog run mode

F260: Jog run frequency

F261: Jog run stopping pattern

F262: Panel jog run mode

- Function
Use the jog run parameters to operate the motor in jog mode. Input of a jog run signal generates a jog run frequency output at once, irrespective of the designated acceleration time.
Also, you can choose an operation panel start/stop mode between the ordinary start/stop mode and the jog run start/stop mode.

The jog run function needs to be assigned to an input terminal. When assigning it to the RES terminal, set **F113** to **18**.

The motor can be operated in jog mode while the jog run setting terminals are connected (RES-CC ON).

Parameter setting

Title	Function	Adjustment range	Default setting
F260	Jog run frequency	F240 -20.0 (Hz)	5.0
F261	Jog run stopping pattern	0: Deceleration stop 1: Coast stop 2: DC braking	0
F262	Panel jog run mode	0: Invalid 1: Valid	0

[Setting of jog run setting terminal (RES-CC)]

Assign control terminal RES as the jog run setting terminal.

Title	Function	Adjustment range	Setting
F113	Input terminal selection (RES)	0-203	18 (Jog run mode)

Note 1: During the jog run mode, there is LOW (low speed detection signal) output but no RCH (designated frequency reach signal) output, and PID control does not work.

Note 2: When the operation panel only is used for operation in jog run mode, the jog run function does not need to be assigned to any input terminal.

<Examples of jog run>

RES-CC (JOG) ON + F-CC ON: Forward jog run

RES-CC (JOG) ON + R-CC ON: Reverse jog run



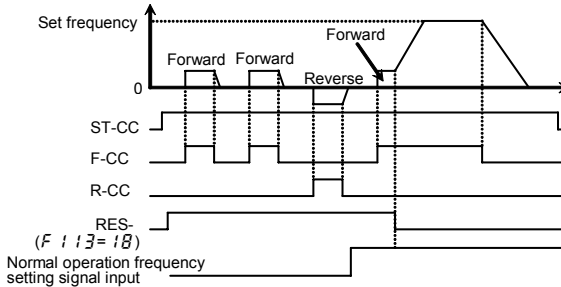

(Normal operation frequency signal input + F-CC ON: Forward run)

(Normal operation frequency signal input + R-CC ON: Reverse run)



- The jog run setting terminal (RES-CC) is enabled when the operation frequency is below the jog run frequency.
This connection does not function at an operation frequency exceeding the jog run frequency.
- The motor can be operated in jog mode while the jog run setting terminals are connected (RES-CC).
- Jog run has priority, even when a new operation command is given during operation.
- Even for $F261=0$ or 1 , an emergency DC braking becomes enabled when setting $F603=2$.
- No limits are imposed to the jog run frequency by the upper-limit frequency (parameter UL).

■ Panel jog mode (if $F262$ is set to 1)

- When the inverter is in panel jog mode, turning the setting dial right  displays $F000$, turning the setting dial left  displays $r000$.
- When $F000$ is displayed, the inverter will be placed in forward jog run mode as long as the  key is held down.
- When $r000$ is displayed, the inverter will be placed in reverse jog run mode as long as the  key is held down.
- During jog run, the direction of rotation can be changed using the setting dial
- If you press and hold down the  key for 20 seconds or more, the key failure alarm " $E-17$ " will be displayed.

Here is the sequence in which modes change each time you press the  key.

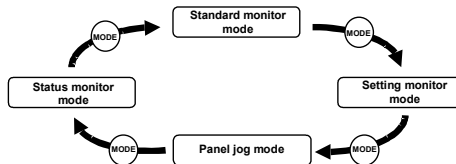

Note: When the inverter is in operation (RUN lamp is blinking) or when an operation command is issued (RUN lamp is lighting), the inverter cannot be switched to panel jog mode.

6.11 Jump frequency - avoiding resonant frequencies

F270: Jump frequency 1

F271: Jumping width 1

F272: Jump frequency 2

F273: Jumping width 2

F274: Jump frequency 3

F275: Jumping width 3

- Function

Resonance due to the natural frequency of the mechanical system can be avoided by jumping the resonant frequency during operation. During jumping, hysteresis characteristics with respect to the jump frequency are given to the motor.

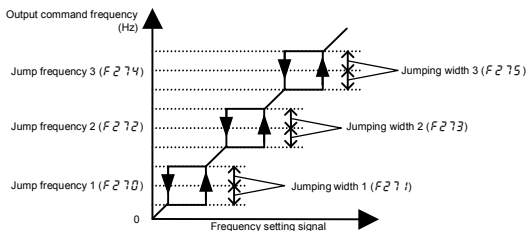

[Parameter setting]

Title	Function	Adjustment range	Default setting
F270	Jump frequency 1	0.0- <i>F_H</i> (Hz)	0.0
F271	Jumping width 1	0.0-30.0 (Hz)	0.0
F272	Jump frequency 2	0.0- <i>F_H</i> (Hz)	0.0
F273	Jumping width 2	0.0-30.0 (Hz)	0.0
F274	Jump frequency 3	0.0- <i>F_H</i> (Hz)	0.0
F275	Jumping width 3	0.0-30.0 (Hz)	0.0

Note 1: Do not set the jump parameters, if multiple jump frequency setting width overlap.

Note 2: During acceleration or deceleration, the jumping function is disabled for the operation frequency.

6.12 Preset-speed frequencies

F287 to **F294**: Preset-speed frequency 8 to 15

Refer to section 3.6 for details.

6.13 Bumpless operation

F295: Bumpless operation selection

F732: Local/remote key prohibition of remote keypad

- **Function**
When switching from Remote mode to Local mode, the status of start and stop, and operating frequency at Remote mode are moved to Local mode.
By contraries, when switching from Local mode to Remote mode, they are not moved to Remote mode.

[Parameter setting]

Title	Function	Adjustment range	Default setting
F295	Bumpless operation selection	0: Disabled 1: Enabled	1
F732	Local/remote key prohibition of remote keypad	0: Permitted 1: Prohibited	1

★ **EASY** key is assigned to Local/remote function.

Set parameter **F750** (EASY key function selection) = 2 (Local / remote key).

EASY lamp is lighting, during selecting local mode.

★ LOC/REM key of remote keypad option (RKP007Z) can be used.

In case, set parameter **F732** (Local/remote key prohibition of remote keypad) = 0 (Permitted).

Operation example : Remote mode ($\overline{F25} = 0$: (Terminal board))

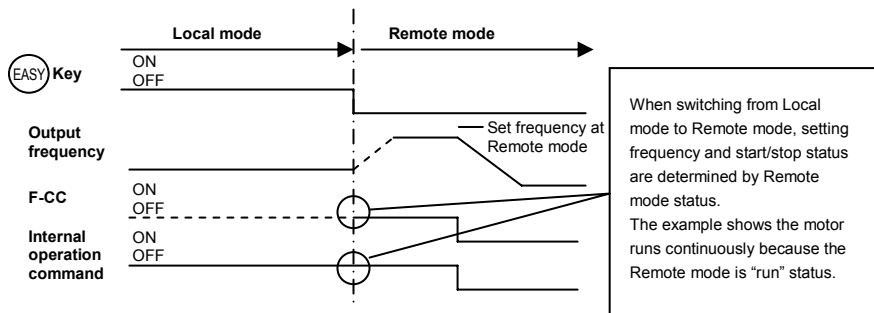
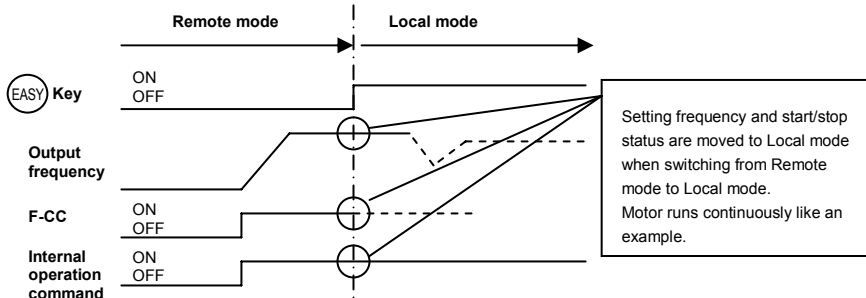

★ To prevent from moving the setting frequency and start/stop status of Remote mode to Local mode, the $\overline{F25}$ is set to "0" (Disabled). In this case, **EASY** key is effective only while stopping.

6.14 PWM carrier frequency

F300: PWM carrier frequency

F312: Random mode

F316: Carrier frequency control mode selection

- Function

- 1) The **F300** parameter allows the tone of the magnetic noise from the motor to be changed by switching the PWM carrier frequency. This parameter is also effective in preventing the motor from resonating with its load machine or its fan cover.
- 2) In addition, the **F300** parameter reduces the electromagnetic noise generated by the inverter. Reduce the carrier frequency to reduce electromagnetic noise. Note: Although the electromagnetic noise level is reduced, the acoustic noise of the motor is increased.
- 3) The random mode improves hearing impression by changing the pattern of the low carrier frequency.

[Parameter setting]

Title	Function	Adjustment range	Default setting
F300	PWM carrier frequency	2.0-16.0 (kHz)	4.0
F312	Random mode	0: Disabled 1: Random mode 1 2: Random mode 2 3: Random mode 3	0
F316	Carrier frequency control mode selection	0: Carrier frequency without reduction 1: Carrier frequency with automatic reduction 2: Carrier frequency not reduced automatically Support for 500V models 3: Carrier frequency reduced automatically Support for 500V models	1

Note 1: Some models need reduced current ratings, depending on the PWM carrier frequency **F300** settings and ambient temperature. Refer to the table on the following pages.

Note 2: When the PWM carrier frequency is set high, selecting "Carrier frequency not reduced automatically" causes the inverter to be tripped more easily than selecting "Carrier frequency reduced automatically."

■ De-rating of rated current.

[Single phase 240V class]

 ☆ Regardless of parameter R_{UL} (Overload characteristic selection) setting, the de-rating of rated currents are as following values.

VFMB1S-	Ambient temperature	PWM carrier frequency		
		2.0k - 4.0 kHz	4.1k - 12.0 kHz	12.1k - 16.0 kHz
2002PL	40°C or less	1.5 A	1.5 A	1.5 A
	40 - 50°C	1.5 A	1.4 A	1.3 A
	50 - 60°C	1.2 A	1.1 A	1.0 A
2004PL	40°C or less	3.3 A	3.3 A	3.3 A
	40 - 50°C	3.3 A	3.0 A	2.8 A
	50 - 60°C	2.6 A	2.3 A	2.2 A
2007PL	40°C or less	4.8 A	4.8 A	4.8 A
	40 - 50°C	4.8 A	4.3 A	4.1 A
	50 - 60°C	3.8 A	3.4 A	3.1 A
2015PL	40°C or less	8.0 A	8.0 A	8.0 A
	40 - 50°C	8.0 A	7.2 A	6.8 A
	50 - 60°C	6.4 A	5.6 A	5.2 A
2022PL	40°C or less	11.0 A	11.0 A	11.0 A
	40 - 50°C	11.0 A	9.9 A	9.4 A
	50 - 60°C	8.8 A	7.7 A	7.2 A

6

[Three phase 500 V class] (VFMB1-4004 to 4037PL)

 ☆ Regardless of parameter R_{UL} (Overload characteristic selection) setting, the de-rating of rated currents are as following values.

VFMB1-	Ambient temperature	PWM carrier frequency		
		2.0k - 4.0 kHz	4.1k - 12.0 kHz	12.1k - 16.0 kHz
4004PL	40°C or less	1.5 A	1.5 A	1.2 A
	40 - 50°C	1.5 A	1.4 A	1.1 A
	50 - 60°C	1.2 A	1.1 A	0.8 A
4007PL	40°C or less	2.3 A	2.3 A	1.8 A
	40 - 50°C	2.3 A	2.1 A	1.6 A
	50 - 60°C	1.8 A	1.6 A	1.2 A
4015PL	40°C or less	4.1 A	4.1 A	3.3 A
	40 - 50°C	4.1 A	3.7 A	2.9 A
	50 - 60°C	3.3 A	2.9 A	2.1 A
4022PL	40°C or less	5.5 A	5.5 A	4.4 A
	40 - 50°C	5.5 A	5.0 A	3.9 A
	50 - 60°C	4.4 A	3.9 A	2.8 A
4037PL	40°C or less	9.5 A	9.5 A	7.6 A
	40 - 50°C	9.5 A	8.6 A	6.7 A
	50 - 60°C	7.6 A	6.7 A	4.8 A

[Three phase 500 V class] (VFMB1-4055 to 4150PL)

★ In case of parameter RUL (Overload characteristic selection) = 1 (Constant torque characteristic) setting

VFMB1-	Ambient temperature	PWM carrier frequency		
		2.0k - 4.0 kHz	4.1k - 12.0 kHz	12.1k - 16.0 kHz
4055PL	50°C or less	14.3 A	13.0 A	11.5 A
	50 ~ 60°C	11.4 A	11.4 A	9.2 A
4075PL	50°C or less	17.0 A	17.0 A	14.0 A
	50 ~ 60°C	13.6 A	13.6 A	10.9 A
4110PL	50°C or less	27.7 A	25.0 A	20.0 A
	50 ~ 60°C	22.2 A	19.4 A	15.2 A
4150L	50°C or less	33.0 A	30.0 A	26.0 A
	50 ~ 60°C	26.4 A	23.0 A	18.0 A

★ In case of parameter RUL (Overload characteristic selection) = 2 (Variable torque characteristic) setting



VFMB1-	Ambient temperature	PWM carrier frequency		
		2.0k - 4.0 kHz	4.1k - 12.0 kHz	12.1k - 16.0 kHz
4055PL	40°C or less	17.0 A	13.0 A	11.5 A
	40 ~ 50°C	15.3 A	13.0 A	11.5 A
	50 ~ 60°C	13.6 A	11.4 A	9.2 A
4075PL	40°C or less	23.0 A	17.0 A	14.0 A
	40 ~ 50°C	20.7 A	17.0 A	14.0 A
	50 ~ 60°C	18.4 A	13.6 A	10.9 A
4110PL	40°C or less	33.0 A	25.0 A	20.0 A
	40 ~ 50°C	29.7 A	25.0 A	20.0 A
	50 ~ 60°C	26.4 A	19.4 A	15.2 A
4150PL	40°C or less	40.0 A	30.0 A	26.0 A
	40 ~ 50°C	36.0 A	30.0 A	26.0 A
	50 ~ 60°C	36.0 A	23.0 A	18.0 A

- * If ambient temperature exceeds 40°C (or 50°C), reduce current according to table above.
- * The table above is the value when the inverter is installed in general described in section 1.4.4.
In case of the other Installation, refer to added instruction manual "Explanation of load reduction".
- * If parameter $F315=0$ or 2 , and current is increased to the automatic reduction level, the OL alarm occurs, if current is increased further $OL3$ trips.
In this case, to avoid such trips, reduce the stall prevention level ($F50i$) properly.
- * Random mode is exercised when the motor is operated in a low-frequency range where it produces annoying acoustic noise.
As the three kinds of timbre mode ($F312=1, 2, 3$) are prepared, the proper mode can be selected to fit the load condition.
If the carrier frequency ($F300$) is set above 8.0 kHz, the random mode function will not be performed, because the level of motor magnetic noise is low at high carrier frequencies.
- * If parameter $F315$ (Carrier frequency control mode selection) = 2 or 3 , set parameter $F300$ (PWM carrier frequency) below 4.0kHz. Output voltage may reduce.
- * PWM carrier frequency is increased at high output frequency area to be stable the operation, even if $F300$ is set to low PWM carrier frequency.
- * In case of $RUL=2$ setting, be sure to install the input AC reactor (ACL) between power supply and inverter.

6.15 Trip-less intensification

6.15.1 Auto-restart (Restart of coasting motor)

F301: Auto-restart control selection

 Caution	
 Mandatory action	<ul style="list-style-type: none"> Stand clear of motors and mechanical equipment. If the motor stops due to a momentary power failure, the equipment will start suddenly when power is restored. This could result in unexpected injury. Attach warnings about sudden restart after a momentary power failure on inverters, motors and equipment for prevention of accidents in advance.

- Function
The **F301** parameter detects the rotating speed and rotational direction of the motor during coasting at the event of momentary power failure, and then after power has been restored, restarts the motor smoothly (motor speed search function). This parameter also allows commercial power operation to be switched to inverter operation without stopping the motor.
During operation, "r t r 4" is displayed.

[Parameter setting]

Title	Function	Adjustment range	Default setting
F301	Auto-restart control selection	0: Disabled 1: At auto-restart after momentary stop 2: At ST terminal off and on 3: 1 + 2 4: At start-up	0

* If the motor is restarted in retry mode, this function will operate, regardless of the setting of this parameter.

1) Auto-restart after momentary power failure (Auto-restart function)

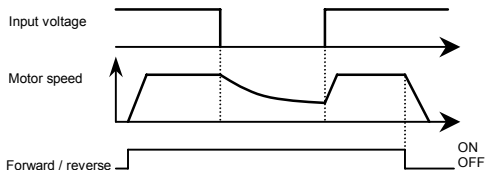

- ★ Setting **F301** to **1** or **3**: This function operates after power has been restored following detection of an undervoltage by the main circuits and control power.

2) Restarting motor during coasting (Motor speed search function)

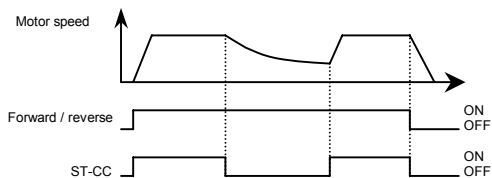

- ★ Setting $F30$ to 2 or 3: This function operates after the ST-CC terminal connection has been opened first and then connected again.

Note: The terminal function ST needs to be assigned to an input terminal, using the parameters $F11$ to $F15$.

3) Motor speed search at starting

When $F30$ is set to 4, a motor speed search is performed each time operation is started.

This function is useful especially when the motor is not operated by the inverter but it is running because of external force.

Warning!!

- At restart, it takes about 1 second for the inverter to check to see the number of revolutions of the motor.
For this reason, the start-up takes more time than usual.
- Use this function when operating a system with one motor connected to one inverter.
This function may not operate properly in a system configuration with multiple motors connected to one inverter.
- In case of using this function, do not set the output phase failure detection selection ($F505$).

Application to a crane or hoist

The crane or hoist may have its load moved downward during the above waiting time from input of the operation starting command to the restart of the motor. To apply the inverter to such machines, therefore, set the auto-restart control mode selection parameter to " $F30 = 0$ " (Disabled). Do not use the retry function, either.

6.15.2 Regenerative power ride-through control/Deceleration stop during power failure/Synchronized acceleration/deceleration

F302 : Regenerative power ride-through control

F317 : Synchronized deceleration time

F318 : Synchronized acceleration time

• Function

- 1) Regenerative power ride-through control: When momentary power failure occurs during operation, this function makes operation continue using the regeneration energy from a motor.
- 2) Deceleration stop during power failure: When momentary power failure occurs during operation, this function stops the motor quickly compulsorily. A forcible stop is carried out using the regeneration energy from the motor. (Deceleration time varies with control.) When operation is stopped, the message "S t P" is displayed (alternately) on the operation panel.
After the forced stop, the inverter remains static until you put off the operation command momentarily.
- 3) Synchronized acceleration/deceleration: When the inverter is used with textile machines, this function stops more than one textile machine simultaneously in the event of a momentary power failure and it prevents the breakage of yarns around bobbins at the recovery from the power failure

[Parameter setting]

Title	Function	Adjustment range	Default setting
F302	Regenerative power ride-through control (Deceleration stop)	0: Disabled 1: Regenerative power ride-through control 2: Deceleration stop during power failure 3: Synchronized acceleration / deceleration (signal) 4: Synchronized acceleration / deceleration (signal + failure)	0
F317	Synchronized deceleration time (time elapsed between start of deceleration to stop)	0.0-3600 (360.0) (s)	2.0
F318	Synchronized acceleration time (time elapsed between start of acceleration to achievement of specified speed)	0.0-3600 (360.0) (s)	2.0

Note 1: The deceleration time and the acceleration time when F302=3 or 4 depend on the setting of F317 and that of F318, respectively.

Note 2: Even if these functions are used, a motor may coast according to load conditions.

In this case, use the auto-restart function (F301) along with this parameter function.

Note 3: Jog run function doesn't operate at synchronized acceleration/deceleration.

- An example of setting when $F302 = 1$
 [When power is interrupted]

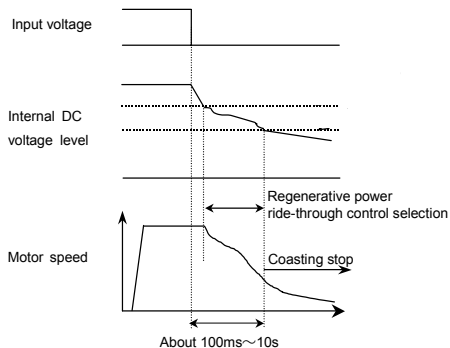

- ★ The time for which the operation of the motor can be continued depends on the machine inertia and load conditions. Before using this function, therefore, perform verification tests.
- ★ Use with the retry function allows the motor to be restarted automatically without being brought to an abnormal stop.

*1: Note: If power is interrupted during deceleration stop, power ride-through control will not be performed.

[If momentary power failure occurs]

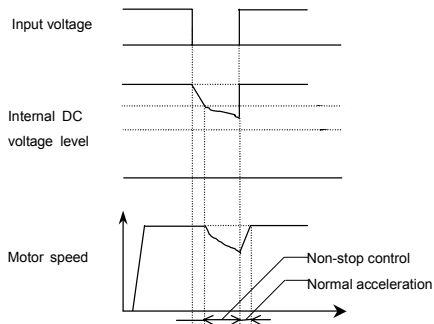

*1: Note: If power is interrupted during deceleration stop, power ride-through control will not be performed.

■ An example of setting when $F302=2$

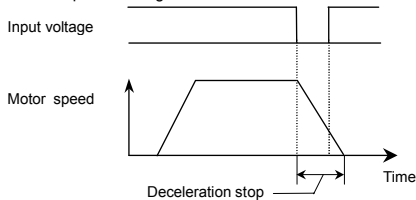

- Even after the recovery from an input power failure, the motor continues deceleration stop. If the voltage in the inverter main circuit falls below a certain level, however, control will be stopped and the motor will coast.
- If the voltage in main circuit FF at Non-stop control during power failure, the motor will coast and inverter display is shown "5L0P" (displayed alternately)". And then, if recovery from the input power failure, the motor continues coasting.

■ An example of setting when $F302=3$ (when the function of receiving synchronized acceleration/deceleration signals is assigned to the input terminal S1)

$F114$ (Input terminal function selection 4A (S1)) = 52 (Power failure synchronized signal)

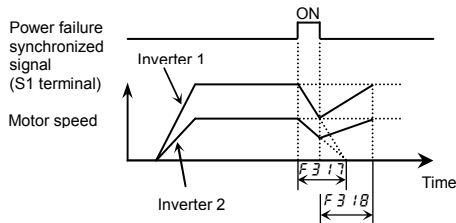

- If the parameters $F317$, $F318$ are set for same acceleration and deceleration time and if power failure synchronized signal set using the input terminal functions (52 , 53) are used, multiple motors can be stopped at about the same time or speed commands can be issued to them at about the same time.
- If a power failure synchronized signal is impressed, the synchronized deceleration frequency to 0Hz to decelerate the motor linearly within the time specified with $F317$. (The S-pattern operation function or the braking sequence cannot be used along with this function.)
When the motor comes to a full stop, the message "5L0P" appears on the display panel.
- If the synchronized acceleration/deceleration signal is canceled during synchronized deceleration, the synchronized acceleration function increases the output frequency to the frequency at the start of synchronized deceleration or to the command frequency, whichever is lower, to accelerate the motor linearly within the time specified with $F318$. (The S-pattern operation function, the braking sequence or the auto-tuning function cannot be used along with this function.)
When acceleration is started, the message "5L0P" on the display panel disappears.
- If a forward/reverse switching command or a stop command is issued during synchronized acceleration or deceleration, synchronized acceleration or deceleration will be canceled.

- When the motor is started again after the synchronized deceleration function stop, turn off the power failure synchronized signal.
- In case of using the synchronized deceleration function, confirm not to work overvoltage stall prevention function during deceleration.

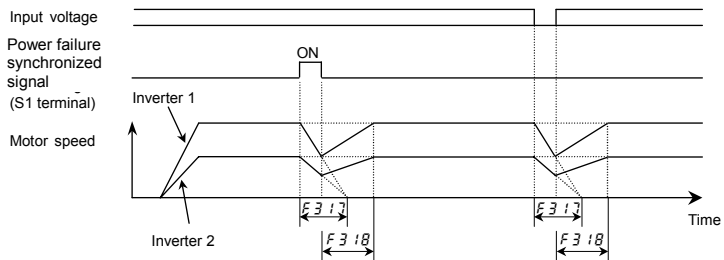

■ An example of setting when $F302=4$

Synchronized deceleration if a synchronized acceleration/deceleration signal is impressed or if a power failure occurs, or synchronized acceleration if the synchronized acceleration/deceleration signal is canceled.



6.15.3 Retry function

F303: Retry selection (number of times)

 Caution	
 Mandatory action	<ul style="list-style-type: none"> Do not go near the motor in alarm-stop status when the retry function is selected. The motor may suddenly restart, which could result in injury. Take measures for safety, e.g. attach a cover to the motor, to prevent accidents if the motor suddenly restarts.

- Function
This parameter resets the inverter automatically when the inverter gives an alarm. During the retry mode, the motor speed search function operated automatically as required and thus allows smooth motor restarting.

[Parameter setting]

Title	Function	Adjustment range	Default setting
F303	Retry selection (number of times)	0: Disabled, 1-10 (Times)	0

The likely causes of tripping and the corresponding retry processes are listed below.

Cause of tripping	Retry process	Canceling conditions
Momentary power failure	Up to 10 times in succession	The retry function will be canceled at once if tripping is caused by an unusual event other than: momentary power failure, overcurrent, overvoltage or overload. This function will also be canceled if retrying is not successful within the specified number of times.
Overcurrent	1st retry: About 1 sec after tripping	
Overvoltage	2nd retry: About 2 sec after tripping	
Overload	3rd retry: About 3 sec after tripping	
Overheating	⋮	
	10th retry: About 10 sec after tripping	

- ★ Retry is only done when the following trips occur.
OC1, OC2, OC3, OP1, OP2, OP3, OL1, OL2, OL3, OH, SQUt
- ★ Protective operation detection relay signals (FLA, FLB, FLC terminal signals) are not sent during use of the retry function. (Default setting)
- ★ To allow a signal to be sent to the protective action detection relay (FLA, B and C terminals) even during the retry process, assign function numbers *146* or *147* to **F132**.
- ★ A virtual cooling time is provided for overload tripping (*OL1, OL2*).
In this case, the retry function operates after the virtual cooling time and retry time.
- ★ In the event of tripping caused by an overvoltage (*OP1* to *OP3*), the retry function will not be activated until the voltage in the DC section comes down to a normal level.
- ★ In the event of tripping caused by overheating (*OH*), the retry function will not be activated until the temperature in the inverter comes down low enough for it to restart operation.
- ★ During retrying, the blinking display will alternate between *r t r Y* and the monitor display specified by status monitor display mode selection parameter **F710**.
- ★ The number of retries will be cleared if the inverter is not tripped for the specified period of time after a successful retry.
"A successful retry" means that the inverter output frequency reaches the command frequency without causing the inverter to re-trip.

6.15.4 Dynamic (regenerative) braking - For abrupt motor stop

F304: Dynamic braking selection

F308: Dynamic braking resistance

F309: Allowable continuous braking resistance

F626: Over-voltage stall protection level

- Function

The inverter does not contain a braking resistor. Connect an external braking resistor in the following cases to enable dynamic braking function:

- 1) when decelerating the motor abruptly or if overvoltage tripping (*OP*) occurs during deceleration stop
- 2) when a continuous regenerative status occurs during downward movement of a lift or the winding-out operation of a tension control machine
- 3) when the load fluctuates and a continuous regenerative status results even during constant speed operation of a machine such as a press

[Parameter setting]

Title	Function	Adjustment range	Default setting
F304	Dynamic braking selection	0: Disabled 1: Enabled, Resistor overload protection enabled 2: Enabled 3: Enabled, Resistor overload protection enabled (At ST terminal on) 4: Enabled (At ST terminal on)	0
F308	Dynamic braking resistance	1.0-1000 (Ω)	Depending on models (See Section 11.4)
F309	Allowable continuous braking resistance	0.01-30.00 (kW)	
F626	Over-voltage stall protection level	100-150 (%)	136 (240V class) 141 (500V class)

★ Assigning the braking resistor overload pre-alarm (function number : 30,31) to any logic output terminal, overload status of braking resistor can be output.

Note 1) The operation level of dynamic braking is defined by parameter **F626**.

Note 2) If parameter **F304**=1 to 4, the inverter will be set automatically so as to deal with the regenerative energy from the motor by means of a resistor, without taking any action to limit overvoltage. (The same function as **F305**=1)

1) Connecting an external braking resistor (optional)

Separate-optional resistor (with thermal fuse)

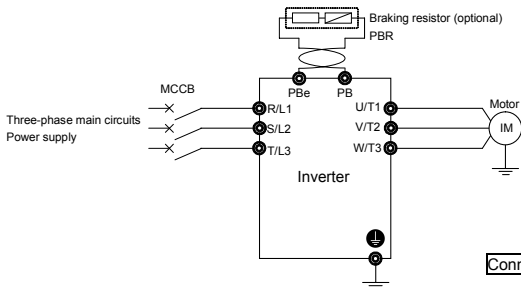

Connecting thermal relays and an external braking resistor

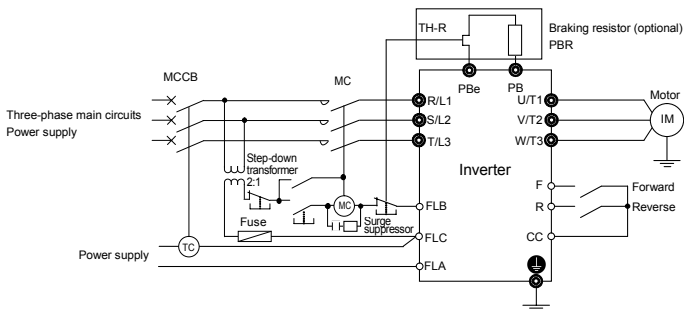

6

Note 1: A TC (Trip coil) is connected, as shown in this figure, when an MCCB with a trip coil is used instead of an MC. A step-down transformer is needed for every 500V-class inverter, but not for any 240V-class inverter.

Note 2: As a last resort to prevent fire, be sure to connect a thermal relay (THR). Although the inverter has a means of preventing overload and overcurrent to protect the braking resistor, the thermal relay is activated in case the protection function fails to work. Select and connect a thermal relay (THR) appropriate to the capacity (wattage) of the braking resistor.

[Parameter setting]

Title	Function	Setting
<i>F304</i>	Dynamic braking selection	1
<i>F305</i>	Overvoltage limit operation	1
<i>F308</i>	Dynamic braking resistance	Proper value
<i>F309</i>	Dynamic braking resistor capacity	Proper value
<i>F626</i>	Over-voltage stall protection level	136 (%) (240V class) 141 (%) (500V class)

- ★ To use this inverter in applications that create a continuously regenerative status (such as downward movement of a lift, a press or a tension control machine), or in applications that require deceleration stopping of a machine with a significant load inertial moment, increase the dynamic braking resistor capacity according to the operation rate required.
- ★ To connect an external dynamic braking resistor, select one with a resultant resistance value greater than the minimum allowable resistance value. Be sure to set the appropriate operation rate in *F308* and *F309* to ensure overload protection.
- ★ When using a braking resistor with no thermal fuse, connect and use a thermal relay as a control circuit for cutting power off.

2) Optional dynamic braking resistors

Optional dynamic braking resistors are listed below. All these resistors are 3%ED in operation rate

Inverter type	Braking resistor		
	Type-form	Rating	Continuous regenerative braking allowable capacity
VFMB1S-2002 to 2007PL	PBR-2007	120W-200Ω	90W
VFMB1S-2015, 2022PL	PBR-2022	120W-75Ω	90W
VFMB1-4004 to 4022PL	PBR-2007	120W-200Ω	90W
VFMB1-4037PL	PBR-4037	120W-160Ω	90W
VFMB1-4055PL	PBR3-4055	240W-80Ω	96W
VFMB1-4075PL	PBR3-4075	440W-60Ω	130W
VFMB1-4110PL	PBR3-4110	660W-40Ω	190W
VFMB1-4150PL	PBR3-4150	880W-30Ω	270W

Note 1: The data in Rating above refer to the resultant resistance capacities (watts) and resultant resistance values (Ω).

Note 2: Braking resistors for frequent regenerative braking are optionally available. For more information, contact your nearest inverter distributor.

Note 3: Type-form of "PBR-" indicate "with thermal fuse" type.

3) Minimum resistances of connectable braking resistors

The minimum allowable resistance values of the externally connectable braking resistors are listed in the table below.

Do not connect braking resistors with smaller resultant resistances than the listed minimum allowable resistance values.

Inverter rated output capacity (kW)	240V Class		500V Class	
	Resistance of standard option	Minimum allowable resistance	Resistance of standard option	Minimum allowable resistance
0.2	200Ω	91Ω	-	-
0.4	200Ω	91Ω	200Ω	114Ω
0.75	200Ω	91Ω	200Ω	114Ω
1.5	75Ω	44Ω	200Ω	67Ω
2.2	75Ω	33Ω	200Ω	67Ω
4.0	-	-	160Ω	54Ω
5.5	-	-	80Ω	43Ω
7.5	-	-	60Ω	28Ω
11	-	-	40Ω	16Ω
15	-	-	30Ω	16Ω

Note: Be sure to set $F308$ (Dynamic braking resistance) at the resistance of the dynamic braking resistor connected.

6.15.5 Avoiding overvoltage tripping

F305: Overvoltage limit operation

F319: Regenerative over-excitation upper limit

F626: Overvoltage stall protection level

- Function

These parameters are used to keep the output frequency constant or increase it to prevent overvoltage tripping in case the voltage in the DC section rises during deceleration or varying speed operation. The deceleration time during overvoltage limit operation may increase above the designated time.

Overvoltage limit operation level



[Parameter setting]

Title	Function	Adjustment range	Default setting
F305	Overvoltage limit operation (Deceleration stop mode selection)	0: Enabled 1: Disabled 2: Enabled (Quick deceleration control) 3: Enabled (Dynamic quick deceleration control)	2
F319	Regenerative over-excitation upper limit	100-160 (%)	120
F626	Overvoltage stall protection level	100-150 (%) *1	136 (240V class) 141 (500V class)

*1: 100% corresponds to an input voltage of 200V for 240V models or to an input voltage of 400V for 500V models.

- ★ If F305 is set to 2 (quick deceleration control), the inverter will increase the voltage to the motor (over-excitation control) to increase the amount of energy consumed by the motor when the voltage reaches the overvoltage protection level, and therefore the motor can be decelerated more quickly than normal deceleration.
- ★ If F305 is set to 3 (dynamic quick deceleration control), the inverter will increase the voltage to the motor (over-excitation control) to increase the amount of energy consumed by the motor as soon as the motor begins to deceleration, and therefore the motor can be decelerated still more quickly than quick deceleration.
- ★ During overvoltage limit operation, the overvoltage pre-alarm (P) blinks is displayed.
- ★ The parameter F319 is used to adjust the maximum energy that the motor consumes during deceleration, and if the inverter is tripped during deceleration because of an overvoltage, specify a larger value. When F305 is set 2 or 3, this function works.
- ★ Parameter F626 serves also as a parameter for setting the regenerative braking level.

6.15.6 Output voltage adjustment/Supply voltage correction

ULU: Base frequency voltage 1

F307: Supply voltage correction (output voltage limitation)

- Function

Base frequency voltage1

The **F307** parameter adjusts the voltage corresponding to the base frequency **ULU** so that no voltage exceeding the **ULU** set value is put out. (This function is enabled only when **F307** is set to either "0" or "1".)

Supply voltage correction

The **F307** parameter maintains a constant V/F ratio, even when the input voltage decreases. The torque during low-speed operation is prevented from decreasing.

Supply voltage correction: Maintains a constant V/F ratio, even when the input voltage fluctuates.

Output voltage limitation: Limits the voltage at frequencies exceeding the base frequency. Applied when operating a special motor with low induced voltage.

[Parameter setting]

Title	Function	Adjustment range	Default setting
ULU	Base frequency voltage1	50-330 (240V class) 50-660 (500V class)	*1
F307	Supply voltage correction (output voltage limitation)	0: Supply voltage uncorrected, output voltage limited 1: Supply voltage corrected, output voltage limited 2: Supply voltage uncorrected, output voltage unlimited 3: Supply voltage corrected, output voltage unlimited	*1

*1: Default setting values vary depending on the setup menu setting. Refer to section 11.5.

- ★ If **F307** is set to "0" or "2", the output voltage will change in proportion to the input voltage.
- ★ Even if the base frequency voltage (**ULU** parameter) is set above the input voltage, the output voltage will not exceed the input voltage.
- ★ The rate of voltage to frequency can be adjusted according to the rated motor capacity. For example, setting **F307** to "0" or "1" prevents the output voltage from increasing, even if the input voltage changes when operation frequency exceeds the base frequency.
- ★ When the V/F control mode selection parameter (**P1**) is set to any number between 2 to 5, the supply voltage is corrected regardless of the setting of **F307**.

[F 30 7=0: No voltage compensation/output voltage limited]

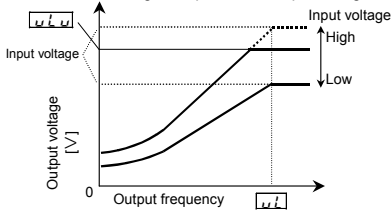

* The above applies when V/F control mode selection parameter $P\tau$ is set to "0" or "1".

$\frac{\text{Rated voltage}}{\text{Rated voltage}} > 1$ the output voltage can be prevented from exceeding the input voltage.

[F 30 7=1: Voltage compensation/output voltage limited]

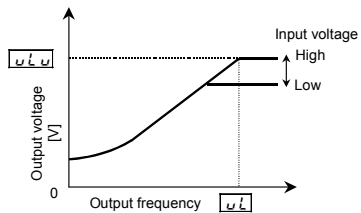

[F 30 7=2: No voltage compensation/no output voltage limit]

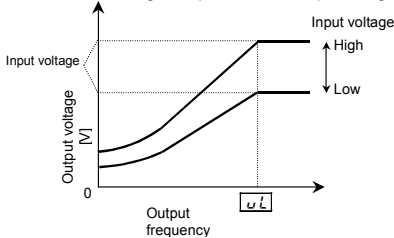

* The above applies when V/F control mode selection parameter $P\tau$ is set to "0" or "1".

$\frac{\text{Rated voltage}}{\text{Rated voltage}} > 1$ the output voltage can be prevented from exceeding the input voltage.

[F 30 7=3: Voltage compensation/no output voltage control]

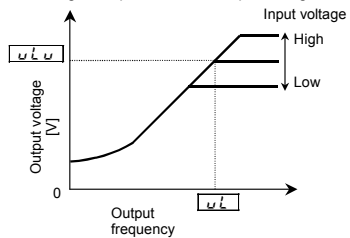

* Note that even if the input voltage is set less than $\omega L \omega$, for a base frequency of $\omega L \omega$ or higher output frequency, then an output voltage over $\omega L \omega$ occurs.

Note: Rated voltage is fixed at 200V for 240V class and 400V for 500V class.

6.15.7 Reverse-run prohibition

F311: Reverse-run prohibition

- Function
This function prevents the motor from running in the forward or reverse direction when it receives the wrong operation signal.

[Parameter setting]

Title	Function	Adjustment range	Default setting
F311	Reverse-run prohibition	0: Forward/reverse run permitted 1: Reverse run prohibited 2: Forward run prohibited	0

6.16 Droop control

F320: Droop gain

F323: Droop insensitive torque band

F324: Droop output filter

- Function
Droop control has the function of preventing loads from concentrating at a specific motor because of a load imbalance when multiple inverters are used to operate one machine.
These parameters are used to allow the motor to "slip" according to the load torque current. Using these parameters, the insensitive torque band and the gain can be adjusted.

[Parameter setting]

Title	Function	Adjustment range	Default setting
F320	Droop gain	0-100 (%)	0
F323	Droop insensitive torque band	0-100 (%)	10
F324	Droop output filter	0.1-200.0	100.0

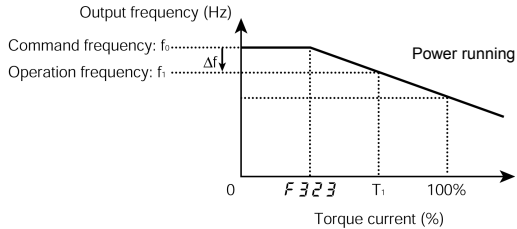

★ The droop control function refers to the function of operating the power-running motor at operating frequency f_1 (Hz) that is lower than command frequency f_0 (Hz) by droop frequency Δf (Hz) when the torque current is T_1 (%). (See the above figure.)

- The droop frequency Δf can be calculated, using the following expression.
Droop frequency Δf (Hz)=base frequency $\omega \text{ L}$ $\times F \text{ 3 2 3}$ $\times (T_1 - F \text{ 3 2 3})$
- When the torque current is above the specified droop insensitive torque band ($F \text{ 3 2 3}$), the frequency is reduced during power running or increased during regenerative braking. The above figure shows an example of the operating frequency during power running. During regenerative braking, control is performed in such a way as to increase the frequency.
- The droop function is activated above the torque current set with $F \text{ 3 2 3}$.
- The amount of droop frequency Δf varies depending on the amount of torque current T_1 .

Note: If the base frequency $\omega \text{ L}$ exceeds 100Hz, count it as 100Hz.

Control is exercised between the starting frequency ($F \text{ 2 4 0}$) and the maximum frequency ($F H$).

[An example of calculation]

Parameter setting: Base frequency $\omega \text{ L}$ =60 (Hz), droop gain $F \text{ 3 2 3}$ =10 (%)

Droop insensitive torque band $F \text{ 3 2 3}$ =30 (%)

Droop frequency Δf (Hz) and operating frequency f_1 when command frequency f_0 is 50 (Hz) and torque current T_1 is 100 (%) are as follows.

$$\begin{aligned} \text{Droop frequency } \Delta f \text{ (Hz)} &= \omega \text{ L} \times F \text{ 3 2 3} \times (T_1 - F \text{ 3 2 3}) \\ &= 60 \text{ (Hz)} \times 10 \text{ (\%)} \times (100 \text{ (\%)} - 30 \text{ (\%)}) \\ &= 4.2 \text{ (Hz)} \end{aligned}$$

$$\text{Operation frequency } f_1 \text{ (Hz)} = f_0 - \Delta f = 50 \text{ (Hz)} - 4.2 \text{ (Hz)} = 45.8 \text{ (Hz)}$$

6.17 Light-load high-speed operation function

- F328** : Light-load high-speed operation selection
- F329** : Light-load high-speed learning function
- F330** : Automatic light-load high-speed operation frequency
- F331** : Light-load high-speed operation switching lower limit frequency
- F332** : Light-load high-speed operation load waiting time
- F333** : Light-load high-speed operation load detection time
- F334** : Light-load high-speed operation heavy load detection time
- F335** : Switching load torque during power running
- F336** : Heavy-load torque during power running
- F337** : Heavy-load torque during constant-speed power running
- F338** : Switching load torque during regenerative braking

⇒ Refer to additional Instruction manual for details.

6

6.18 Braking function

6.18.1 Brake sequence control

- F340** : Creeping time 1
- F341** : Braking mode selection
- F342** : Load portion torque input selection
- F343** : Hoisting torque bias input
- F344** : Lowering torque bias multiplier
- F345** : Brake release time
- F346** : Creeping frequency
- F347** : Creeping time 2
- F348** : Braking time learning function

• Function

These parameters can be used as brake sequences for lifts and similar equipment.

To ensure smooth operation, the motor produces enough torque before the brake is released.

Title	Function	Adjustment range	Default setting
F340	Creeping time 1	0.00-10.00 (s)	0.00
F341	Braking mode selection	0: Disabled 1: Forward winding up 2: Reverse winding up 3: Horizontal operation	0

Title	Function	Adjustment range	Default setting
F342	Load portion torque input selection	0: Disabled, 1: VIA, 2: VIB 3: VIC, 4: F343	0
F343	Hoisting torque bias input (valid only when F342=4)	-250- +250 (%)	100
F344	Lowering torque bias multiplier	0-100 (%)	100
F345	Brake release time	0.00-10.00 (s)	0.05
F346	Creeping frequency	F240 -20.0 (Hz)	3.0
F347	Creeping time 2	0.00-10.00 (s)	0.10
F348	Braking time learning function	0: Disabled 1: Learning (0 after adjustment)	0

Starting procedure

At the run command, the inverter makes the motor produce the torque specified with parameter F343. As soon as a torque output command is issued, a brake release request signal is put out through the brake output terminal. Upon expiration of the brake release time set with F345, the motor starts to accelerate.

Stopping procedure

At the stop command, the operation frequency is decreased to the creep frequency set with parameter F346, and put out the braking request after the creep time 1 set with F340. And then, the creep frequency is maintained for the creep time set with F347. While the creep frequency is maintained, the brake release signal is put out through the braking signal output terminal to apply the brake.

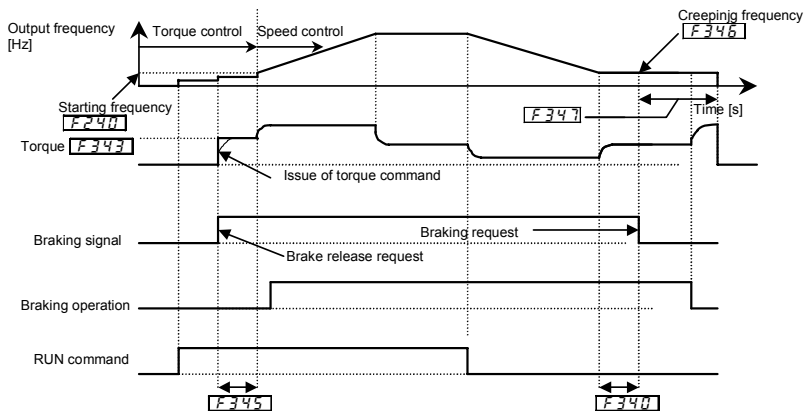

Note 1) Do not change the RUN/STOP and the forward/reverse signal during creep operation.
Set the interlock circuit not to change the above switching.

Ex.) When using the RY-RC terminal as the brake signal output terminal

Title	Function	Adjustment range	Example of setting
F 130	Output terminal function selection 1A (RY-RC)	0-255	68 (Brake release)

■ Learning function [F 348]

Using this function, rough settings can be made automatically and also parameters F 345, F 346 and F 347 can be set automatically.

After the learning function is set, F 342 will be set automatically to 4 and F 343 to 100. If necessary, fine adjust the parameter setting manually.

[Learning operation]

Set parameter F 348 to 1 and enter an operation command to start learning. (The frequency and “t_{un}” are displayed alternately.)

Parameter F 343 (torque) is set, the brake release timing is calculated, and parameter F 345 (release time) is set based on the calculation result. F 346 is set automatically according to the motor constant calculated. At the stop of operation, F 347 (creep time) are set.

Note 2: Learning should be performed under light-load conditions.

Note 3: If a counterweight is provided, a learning error may occur. If so, make an adjustment manually.

Note 4: Brake learning (F 348=1) should be carried out for normal rotation if F 341 is set to 1 (forward winding), or for reverse rotation if F 341 is set to 2 (reverse winding).

[Notabilia for braking function]

Note 5: For the braking functions, the pre-excitation time is automatically determined by the inverter from motor-related constants.

When the VFMB1S-2022PL is used in combination with a Toshiba 4P-2.2kW-60Hz-200V standard motor, the pre-excitation time is approximately 0.1 to 0.2 seconds.

Depending on the motor used, the pre-excitation time may be prolonged.

Note 6: When using braking functions, set parameter R U 2 (automatic torque boost) to 2 (vector control + auto-tuning) or set motor-related parameters F 401 to F 413.

Note 7: When the inverter is confirmed operation by braking functions, connect and run the combined motor.

As this function calculate the timing of brake by detecting output current, calculating error is occurred without connecting the motor.

■ Torque bias function

Using this function, the load can be started smoothly, by the motor produces enough torque for load portion before the brake is released,

[Selection of external signals]

Voltage signals	—	VIA-CC – 0~10V (0~250%)	1
	—	VIB-CC – 0~±10V (-250~250%)	2
Current signals	—	VIC-CC – 4(0)~20mA (0~250%)	3

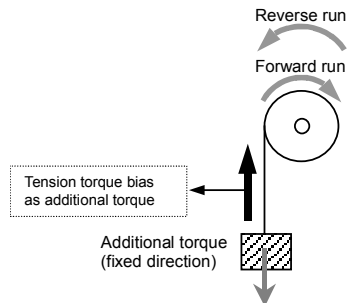

6.18.2 Hit and stop control

F382: Hit and stop control

F383: Hit and stop control frequency

- Function
These parameters can be used as hit and stop control for material handling smooth deceleration and stopping is ensured by limit switch.

[Parameter setting]

Title	Function	Adjustment range	Default setting
F382	Hit and stop control	0: Disabled, 1: Enabled, 2: -	0
F383	Hit and stop control frequency	0.1-30.0 (Hz)	5.0

☆ This function is valid when the parameter **F382** = 1 is set.

Input terminal settings

Assign the following functions to the input terminal, you can operate the hit and stop control by using the terminal's ON/OFF.

Input terminal function	ON	OFF
140 Forward deceleration	Forward operation toward F383 setting	Clear
142 Forward stop	Forward stop	Clear
144 Reverse deceleration	Reverse operation toward F383 setting	Clear
146 Reverse stop	Reverse stop	Clear

Each of the following numbers (141, 143, 145, 147) are reverse signals.

<Sample sequence diagram>

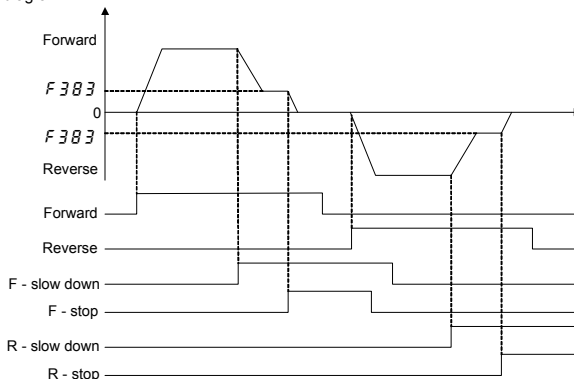

6.19 Acceleration/deceleration suspend function

F349 : Acceleration/deceleration suspend function

F352 : Deceleration suspend frequency

F350 : Acceleration suspend frequency **F353** : Deceleration suspend time

F351 : Acceleration suspend time

• Function

Using these parameters, acceleration or deceleration can be suspended to let the motor run at a constant speed. There are two ways to suspend acceleration or deceleration: suspending it automatically by setting the suspend frequency and time using parameters, and suspending it by means of a signal from an external control device.

These parameters are useful in starting and stopping transfer equipment, textile machines (winders), and so on.

[Parameter setting]

Title	Function	Adjustment range	Setting value
F349	Acceleration/deceleration suspend function	0:Disabled 1:Parameter setting 2:Terminal input	0
F350	Acceleration suspend frequency	0.0- F_H (Hz)	0.0
F351	Acceleration suspend time	0.0-10.0 (s)	0.0
F352	Deceleration suspend frequency	0.0- F_H (Hz)	0.0
F353	Deceleration suspend time	0.0-10.0 (s)	0.0

Note1: The acceleration suspend frequency (**F350**) should not be set below the starting frequency (**F240**).

Note2: The deceleration suspend frequency (**F352**) should not be set below the stop frequency (**F243**).

Note3: If the output frequency is lowered by a stall prevention function, the acceleration suspend function may be activated.

1) To suspend acceleration or deceleration automatically

Set the desired frequency with **F350** or **F352** and the desired time with **F351** or **F353**, and then set **F349** to 1.

When the frequency set is reached, the motor stops accelerating or decelerating to rotate at a constant speed.

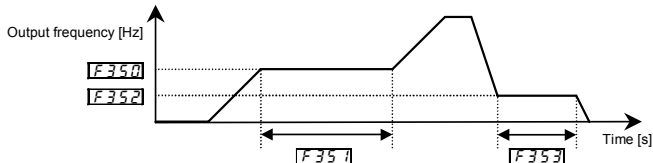

2) To suspend acceleration or deceleration by means of a signal from an external control device

Set $\text{F}50$ for the any terminal signal input terminal. As long as ON signals are inputted, the motor continues to rotate at a constant speed.

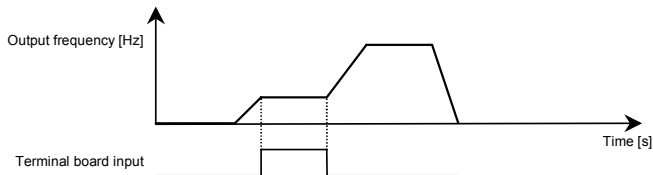

Ex.) When using the S3 terminal as the acceleration/deceleration suspend terminal

Title	Function	Adjustment range	Example of setting
$F115$	Input terminal selection 6 (S3)	0-203	60 (Acceleration/deceleration suspend signal)

■ If the stall control function is activated during constant-speed rotation

The frequency drops momentarily as a result of stall control, but the time for which the frequency drops is included in the suspend time.

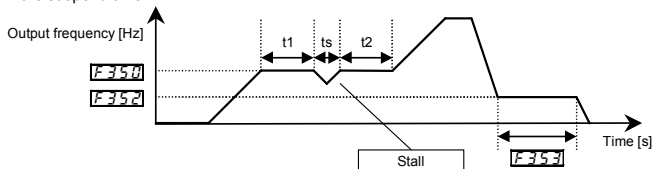

$$F351 \text{ (Momentary acceleration (deceleration) suspend time)} = (t1 + t2 + ts)$$

■ Stall control

Refers to the inverter's function of automatically changing the operation frequency when it detects an overcurrent, overload or overvoltage. Using the following parameters, you can specify the way, the stall control is performed for each kind of stall.

Overcurrent stall : $F501$ (Stall prevention level 1)

Overload stall : 017 (Electronic thermal protection characteristic selection)

Overvoltage stall : $F305$ (Overvoltage limit operation)

Note: Setting the frequency command at the same frequency as the acceleration suspend frequency ($F350$) disables the acceleration suspend function.

Similarly, setting the frequency command at the same frequency as the deceleration suspend frequency ($F352$) disables the deceleration suspend function.

6.20 PID control

F31d : Process input value of PID control	F369 : PID control feedback signal selection
F359 : PID control waiting time	F372 : Process increasing rate (speed type PID control)
F360 : PID control	F373 : Process decreasing rate
F361 : Delay filter	F380 : PID forward/reverse characteristics selection
F362 : Proportional gain	F389 : PID control reference signal selection
F363 : Integral gain	
F366 : Differential gain	
F367 : Process upper limit	
F368 : Process lower limit	

- Function
Using feedback signals (4 to 20mA, 0 to 10V) from a detector, process control can be exercised, for example, to keep the airflow, amount of flow or pressure constant.
Or, it is also possible to always set 0 for integral and differential at terminal input.

[Parameter setting]

Title	Function	Adjustment range	Default setting
<i>F31d</i>	Process input value of PID control	<i>F368</i> - <i>F367</i> (Hz)	0.0
<i>F359</i>	PID control waiting time	0-2400 (s)	0
<i>F360</i>	PID control	0: Disabled 1: Process type PID control 2: Speed type PID control	0
<i>F361</i>	Delay filter	0.0-25.0 (s)	0.1
<i>F362</i>	Proportional gain	0.01-100.0	0.30
<i>F363</i>	Integral gain	0.01-100.0	0.20
<i>F366</i>	Differential gain	0.00-2.55	0.00
<i>F367</i>	Process upper limit	0.0- <i>F367</i> (Hz)	*1
<i>F368</i>	Process lower limit	0.0- <i>F367</i> (Hz)	0.0
<i>F369</i>	PID control feedback signal selection	0: Disabled, 1: VIA, 2: VIB, 3: VIC 4 to 6: -	0
<i>F372</i>	Process increasing rate (speed type PID control)	0.1-600.0 (s)	10.0
<i>F373</i>	Process decreasing rate	0.1-600.0 (s)	10.0

Title	Function	Adjustment range	Default setting
<i>F 380</i>	PID forward/reverse characteristics selection	0: Forward 1: Reverse	0
<i>F 389</i>	PID control reference signal selection	0: <i>F FwdIF 207</i> selected 1: Terminal board VIA 2: Terminal board VIB 3: <i>F P Id</i> 4: RS485 communication 5: UP/DOWN from external logic input 6: CANopen communication 7: Communication option 8: Terminal board VIC 9, 10: - 11: Pulse train input	0

*1: Default setting values vary depending on the setup menu setting.

1) External connection

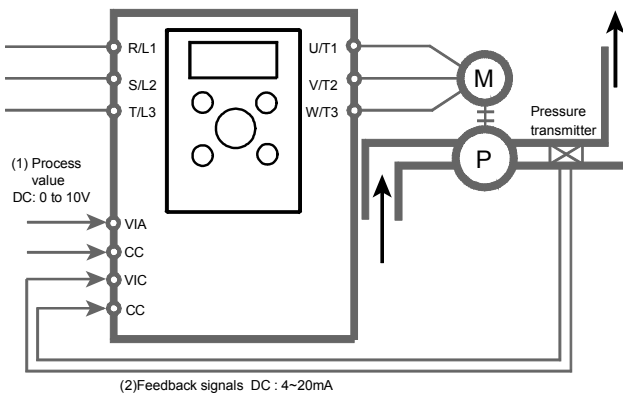

2) Types of PID control interface

Process value (frequency) and feedback value can be combined as follows for the PID control.

(1) Process value	(2) Feedback value
PID control reference signal selection $F 389$	PID control feedback signal selection $F 369$
0: $F n0d/F 207$ selected 1: Terminal board VIA 2: Terminal board VIB 3: $F P id$ 4: RS485 communication 5: UP/DOWN from external logic input 6: CANopen communication 7: Communication option 8: Terminal board VIC 9, 10: - 11: Pulse train input	0: Disabled 1: VIA 2: VIB 3: VIC 4 to 6: -

Note 1: About the setting of $F 389$: Do not select the same terminal that is used feedback terminal.

Note 2: When $F 389$ is selected to 3, process value is set to $F P id$.

Be careful it is not value of $F \zeta$ setting. In case value that is set by setting dial is saved on $F P id$.

Note 3: To make the inverter send out a signal that indicates whether the value of feedback agree with (or reaches) the value of processing, assign the output terminal function 144 or 145 to an unassigned output terminal.

You can also specify a frequency agreement detection range ($F i57$). (Refer to 6.3.4)

6

3) Setting PID control

Set " i " (Process type PID control operation) in the parameter $F 350$ (PID control).

(1) Set parameters $R \zeta \zeta$ (acceleration time), and $d E \zeta$ (deceleration time) to the system fitting values.

(2) Please set the following parameters to place limits to the setting value and the control value.

Placing a limit to the process value : The parameter $F 357$ (Process upper limit), $F 358$ (Process lower limit)

Placing a limit to the output frequency : The parameter $U L$ (Upper limit frequency), $L L$ (Lower limit frequency)

Note 4: Assigning the PID control prohibition (input terminal function number: 36,37) to any logic input terminal, PID control function is stopped during the terminal ON.

4) Adjusting the PID control gain level

Adjust the PID control gain level according to the process quantities, the feedback signals and the object to be controlled.

The following parameters are provided for gain adjustment:

Title	Function	Adjustment range	Default setting
<i>F 362</i>	Proportional gain (P)	0.01 ~ 100.0	0.30
<i>F 363</i>	Integral gain (I)	0.01 ~ 100.0	0.20
<i>F 366</i>	Derivative gain (D)	0.00 ~ 2.55	0.00

F 362 (P-gain adjustment parameter)

This parameter adjusts the proportional gain level during PID control. A correction value proportional to the particular deviation (the difference between the process value and the feedback value) is obtained by multiplying this deviation by the parameter setting.

A larger P-gain adjustment value gives faster response. Too large an adjustment value, however, results in an unstable event such as hunting.

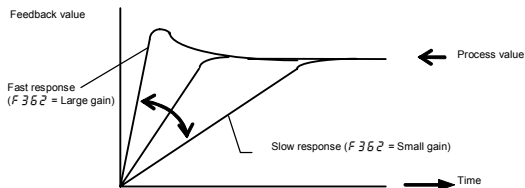

F 363 (I-gain adjustment parameter)

This parameter adjusts the integral gain level during PID control. Any remaining deviations (residual deviation offset) during proportional action are cleared to zero.

A larger I-gain adjustment value reduces residual deviations. Too large an adjustment value, however, results in an unstable event such as hunting.

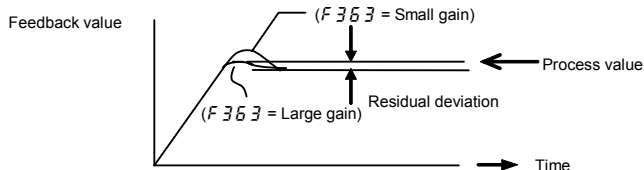

- ★ Assign an input terminal function 52 (PID integral/derivative) to an input terminal, when that input terminal is ON, it is possible to calculate integral/derivative amounts always as 0 (zero).

F356 (D-gain adjustment parameter)

This parameter adjusts the differential gain level during PID control. This gain increases the speed of response to a rapid change in deviation (difference between the process value and the feedback value). Note that setting the gain more than necessary may cause great fluctuations in output frequency, and thus operation to become unstable.

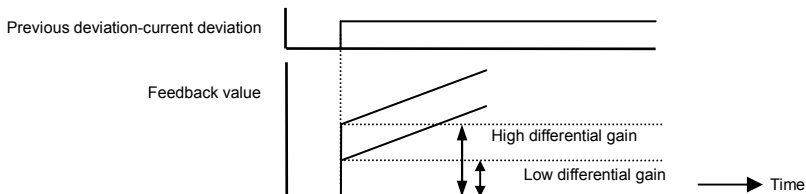

- ★ Assign an input terminal function 52 (PID integral/derivative) to an input terminal, when that input terminal is ON, it is possible to calculate integral/derivative amounts always as 0 (zero).

5) Adjusting feedback input

To use external feedback input (VIA, VIB, VIC), perform voltage/current-scaling adjustments (input point setting) as required. Refer to section 6.6.2 for details.

If the feedback input data is too small, voltage-scaling adjustment data can also be used for gain adjustment.

Example of 0 - 10 Vdc voltage input setting

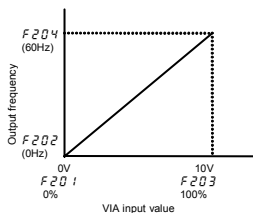

Example of 0 - 10 Vdc voltage input setting

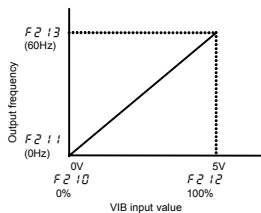

Example of 4 - 20 mAdc voltage input setting

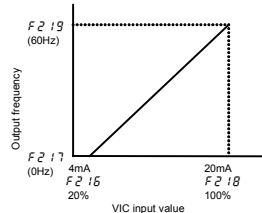

6) Setting the time elapsed before PID control starts

You can specify a waiting time for PID control to prevent the inverter from starting PID control before the control system becomes stable, for example, after start-up.

The inverter ignores feedback input signals, carries out operation at the frequency determined by the amount of processing for the period of time specified with $F 359$ and enters the PID control mode after a lapse of the specified time.

7) PID control forward/reverse characteristic switch

PID input characteristics can be reversed.

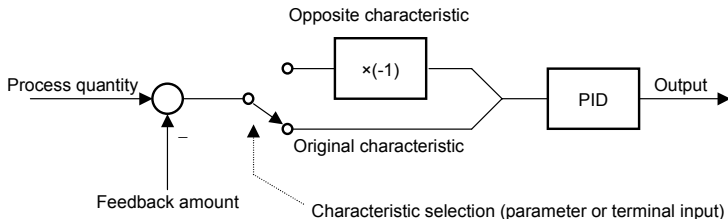

- When characteristic is reversed according to parameters
When PID calculation reverse selection parameter $F 380$ is 1: Set reverse characteristics.
- When characteristic is reversed using logic input terminal
Input terminal function 54/55: Assign to switch PID characteristics.
(Caution) If reverse characteristics is selected for parameter $F 380$ and terminal input at the same time, they become forward characteristic.

6.21 Setting motor constants

6.21.1 Setting motor constants for induction motors

F400: Auto-tuning

F415: Motor rated current

F401: Slip frequency gain

F416: Motor no-load current

F402: Automatic torque boost value

F417: Motor rated speed

F405: Motor rated capacity

F459: Load inertia moment ratio

To use vector control, automatic torque boost and automatic energy saving, motor constant setting (motor tuning) is required. The following three methods are available to set motor constants.

- Using the torque boost setting macro function (**RU2**) for setting the V/F control mode selection (**Pt**) and auto-tuning (**F400**) at the same time
- Setting V/F control mode selection (**Pt**) and auto-tuning (**F400**) independently
- Combining the V/F control mode selection (**Pt**) and manual tuning

Caution:

If the settings for V/F control mode selections **Pt** are **2**: automatic torque boost control, **3**: vector control, **4**: energy-saving, **5**: Dynamic energy-saving.

Look at the motor's name plate and set the following parameters.

- uL** : Base frequency 1 (rated frequency)
- uLv** : Base frequency voltage 1 (rated voltage)
- F405**: Motor rated capacity
- F415**: Motor rated current
- F417**: Motor rated speed

Set the other motor constants as necessary.

[Selection 1: Setting by parameter setting macro torque boost]

This is the easiest of the available methods. It conducts vector control and auto-tuning at the same time.

Be sure to set the motor for **uL**, **uLv**, **F405**, **F415**, **F417**.

Set **RU2** to **1** (Automatic torque boost + auto-tuning)

Set **RU2** to **2** (Vector control + auto-tuning).

Set **RU2** to **3** (Energy-saving + auto-tuning)

Refer to section 5.5 for details of the setting method.

[Selection 2: Setting vector control and auto-tuning independently]

Set vector control, automatic torque boost, and energy saving and auto-tuning individually.

After setting $P\grave{e}$ (V/F control mode selection), auto-tuning occurs.

Set the auto-tuning parameter $F400$ to $\bar{2}$ (Auto-tuning enabled)

[Parameter setting]

Title	Function	Adjustment range	Default setting
$F400$	Auto-tuning	0: Auto-tuning disabled 1: Initialization of $F402$ (after execution : 0) 2: Auto-tuning executed (after execution: 0) 3: - 4: Motor constant auto calculation (after execution: 0) 5: 4+2 (after execution: 0)	0

Set $F400$ to $\bar{2}$ to before the start of operation. Tuning is performed at the start of the motor.

★ Precautions on auto-tuning

- (1) Conduct auto-tuning only after the motor has been connected and operation completely stopped.
If auto-tuning is conducted immediately after operation stops, the presence of a residual voltage may result in abnormal tuning.
- (2) Voltage is applied to the motor during tuning even though it barely rotates. During tuning, "AEn" is displayed on the operation panel.
- (3) Tuning is performed when the motor starts for the first time after $F400$ is set to $\bar{2}$.
Tuning is usually completed within three seconds. If it is aborted, the motor will trip with the display of EEn and no constants will be set for that motor.
- (4) High-speed motors, high-slip motors or other special motors cannot be auto-tuned. For these motors, perform manual tuning using Selection 3 described below.
- (5) Provide cranes and hoists with sufficient circuit protection such as mechanical braking. Without sufficient circuit protection, the resulting insufficient motor torque during tuning could create a risk of machine stalling/falling.
- (6) If auto-tuning is impossible or an "EEn" auto-tuning error is displayed, perform manual tuning with selection 4.

[Selection 3: Setting vector control and motor constant automatically]

After setting parameter $uL.uL.uL$, $F405$, $F415$ and $F417$, parameter $F402$ and $F416$ are calculated automatically by calculating motor constants.

Set the motor constant parameter $F400$ to $\bar{4}$ (auto calculation)

Set $F400=5$, when auto-tuning is executed after setting motor constants automatically.

[Selection 4: Setting vector control and manual tuning independently]

If an "EEn" tuning error is displayed during auto-tuning or when vector control characteristics are to be improved, set independent motor constants.

[Parameter setting]

Title	Function	Adjustment range	Default setting
<i>F401</i>	Slip frequency gain	0-150 (%)	50
<i>F402</i>	Automatic torque boost value	0.1-30.0 (%)	Depends on the capacity (Refer to section 11.4)
<i>F405</i>	Motor rated capacity	0.01-22.00 (kW)	
<i>F415</i>	Motor rated current	0.1-100.0 (A)	
<i>F416</i>	Motor no-load current	10-90 (%)	
<i>F417</i>	Motor rated speed	100-64000 (min ⁻¹)	*1
<i>F459</i>	Load inertia moment ratio	0.1-100.0 (times)	1.0
<i>tHr</i>	Motor electronic thermal protection level 1	10-100 (%) / (A)	100

*1: Default setting values vary depending on the setup menu setting. Refer to section 11.5.

Setting procedure Adjust the following parameters:

- F401*: Set the compensation gain for the slipping of the motor. A higher slip frequency reduces motor slipping correspondingly. After setting *F417*, set *F401* to adjust in detail. Be careful as inputting a value larger than necessary causes hunting and other unstable operation.
- F402*: Adjust the primary resistive component of the motor. Decreases in torque due to a possible voltage drop during low-speed operation can be suppressed by setting a large value in this parameter. Be careful as setting a value larger than necessary may lead to an increased current causing a trip at low speeds. (Perform adjustments according to the actual operation.)
- F405*: Set the motor's rated capacity according to the motor's name plate or test report.
- F415*: Set the rated current of the motor. For the rated current, see the motor's nameplate or test report.
- F416*: Set the ratio of the no-load current of the motor to the rated current. Enter the value in % that is obtained by dividing the no-load current specified in the motor's test report by the rated current. Increasing this value increases the excitation current.
- F417*: Set the rated rotational speed of the motor. For the rated current, see the motor's nameplate or test report.

★ Adjustment method for the moment of inertia of the load

F459: Adjusts the excess response speed. A larger value gives a smaller overshoot at the acceleration/deceleration completion point. In the default settings, the moment of inertia of the load (including the motor shaft) value is optimally set considering a motor shaft of 1x. When the moment of inertia of the load is not 1x, set a value that matches that actual moment of inertia of the load.

tHr: If the rated capacity of the motor is one size smaller than that of the inverter, lower the thermal protective level according to the rated current of the motor.

* Sensorless vector control may not operate properly if the motor capacity differs from the applicable rated capacity of the inverter by more than two grades.

Caution:

If a combination of the inverter rating and the motor capacity is different for more than 2 items, vector control may not operate correctly.

6.21.2 Setting motor constants for PM motors

F400	: Auto-tuning	F459	: Load inertia moment ratio
F402	: Automatic torque boost value	F912	: q-axis inductance
F405	: Motor rated capacity	F913	: d-axis inductance
F415	: Motor rated current	F915	: PM control mode selection
F417	: Motor rated speed		

To use vector control for PM machine is required. Setting V/F control mode selection ($P\tau$) should be set as 5

Caution:

If the settings for V/F control mode selections $P\tau$ is 5: vector control for PM machine
Look at the motor's name plate and set the following parameters.

- ωL : Base frequency 1 (rated frequency) that is calculated from Back EMF
- ωU : Base frequency voltage 1 (rated voltage) that is calculated from Back EMF
- F405**: Motor rated capacity
- F415**: Motor rated current
- F417**: Motor rated speed
- F912**: Q axis inductance per phase
- F913**: D axis inductance per phase

[1: Setting auto-tuning]

After setting $P\tau = 5$, auto-tuning occurs.

Set the auto-tuning parameter **F400** to 2 (Auto-tuning enabled)

[Parameter setting]

Title	Function	Adjustment range	Default setting
F400	Auto-tuning	0: Auto-tuning disabled 1: Initialization of F402 , F912 , F913 (after execution : 0) 2: Auto-tuning executed (after execution: 0) 3: - 4: - 5: -	0

Note1) When parameter $P\tau = 5$ is selected, **F400=3** to **5** do not work.

Set $F402$ to 2 before the start of operation. Tuning is performed at the start of the motor.

★ Precautions on auto-tuning

- (1) Conduct auto-tuning only after the motor has been connected and operation completely stopped.
If auto-tuning is conducted immediately after operation stops, the presence of a residual voltage may result in abnormal tuning.
- (2) Voltage is applied to the motor during tuning even though it barely rotates. During tuning, "Rtn" is displayed on the operation panel.
- (3) Tuning is performed when the motor starts for the first time after $F402$ is set to 2.
Tuning is usually completed within three seconds. If it is aborted, the motor will trip with the display of "Err" and no constants will be set for that motor.
- (4) High-speed motors or other special motors cannot be auto-tuned. For these motors, perform manual tuning using Selection 2 described below.
- (5) Provide cranes and hoists with sufficient circuit protection such as mechanical braking. Without sufficient circuit protection, the resulting insufficient motor torque during tuning could create a risk of machine stalling/falling.
- (6) If auto-tuning is impossible or an "Err" auto-tuning error is displayed, perform manual tuning with Selection 2.

[2: How to do manual tuning]

If an "Err" tuning error is displayed during auto-tuning or when vector control characteristics are to be improved, set motor constants manually.

[Parameter setting]

Title	Function	Adjustment range	Default setting
$F402$	Automatic torque boost value	0.1-30.0 (%)	Depends on the capacity (Refer to section 11.4)
$F405$	Motor rated capacity	0.01-22.00 (kW)	
$F415$	Motor rated current	0.1-100.0 (A)	
$F417$	Motor rated speed	100-64000 (min^{-1})	*1
$F459$	Load inertia moment ratio	0.1-100.0 (times)	1.0
$F912$	Q axis inductance per phase	0.01-650.0 (mH)	10.00
$F913$	D axis inductance per phase	0.01-650.0 (mH)	10.00
tHr	Motor electronic thermal protection level 1	10-100 (%) / (A)	100

*1: Default setting values vary depending on the setup menu setting.

Setting procedure Adjust the following parameters:

$F402$: Adjust the primary resistive component of the motor. Decreases in torque due to a possible voltage drop during low-speed operation can be suppressed by setting a large value in this parameter. Be careful as setting a value larger than necessary may lead to an increased current causing a trip at low speeds. (Perform adjustments according to the actual operation.) If the test report exists, see the stator resistance value per phase.

$$F402 = \sqrt{3} \cdot R_s \cdot F415 / V_{type} \cdot 100 [\%]$$

R_s (Stator resistance per phase in ohm) V_{type} is 200 or 400 [V] (depend on voltage type)

$F405$: Set the motor's rated capacity according to the motor's name plate or test report.

$F415$: Set the rated current of the motor. For the rated current, see the motor's nameplate or test report.

$F417$: Set the rated rotational speed of the motor. For the rated current, see the motor's nameplate or test report.

★ Adjustment method for the moment of inertia of the load

$F459$: Adjusts the excess response speed. A larger value gives a smaller overshoot at the acceleration/deceleration completion point. In the default settings, the moment of inertia of the load (including the motor shaft) value is optimally set considering a motor shaft of 1x. When the moment of inertia of the load is not 1x, set a value that matches that actual moment of inertia of the load.

t_{Hr} : If the rated capacity of the motor is one size smaller than that of the inverter, lower the thermal protective level according to the rated current of the motor.

* Sensorless vector control may not operate properly if the motor capacity differs from the applicable rated capacity of the inverter by more than two grades.

Caution:

If a combination of the inverter rating and the motor capacity is different for more than 2 items, vector control may not operate correctly.

[3: Optimization of starting torque]

Even if auto-tuning is done, rotor cannot start due to heavy load, set the $F915$ to 4 to activate the optimization of starting torque.

[Parameter setting]

Title	Function	Adjustment range	Default setting
$F915$	PM control type	0: Mode 0 1: Mode 1 2: Mode 2 3: Mode 3 4: Mode 4	3

- ★ $F915 = 0$ (Mode 0): Without initial position detection (Rotor may rotate opposite direction at starting)
 1 (Mode 1): Initial position detection for high saliency motor
 2 (Mode 2): Initial position detection for high saliency motor Optimization for starting torque
 3 (Mode 3): Initial position detection for weak saliency motor
 4 (Mode 4): Initial position detection for weak saliency motor Optimization for starting torque

Note2) $F412$, $F458$, $F460$ to $F467$, $F480$ to $F499$ (Motor specific coefficient 1 to 11) are manufacturer setting parameters. Do not change the value of these parameters.

6.22 Torque limit

6.22.1 Torque limit switching

F441 : Power running torque limit 1 level

F443 : Regenerative braking torque limit 1 level

F444 : Power running torque limit 2 level

F445 : Regenerative braking torque limit 2 level

F454 : Constant output zone torque limit selection

• Function

This function is to decrease or increase the output frequency according to the loading condition when the motor torque reaches the limit level. Setting a torque limit parameter at 250% means "Invalid."

With this function, you can also select from between limiting the constant output or limiting the constant torque in the constant output zone.

This function is not operate when the parameter $P\tau = 0, 1, 7$ setting.

■ Setting methods

When setting limits to torque, use internal parameters (Torque limits can also be set with an external control device.)

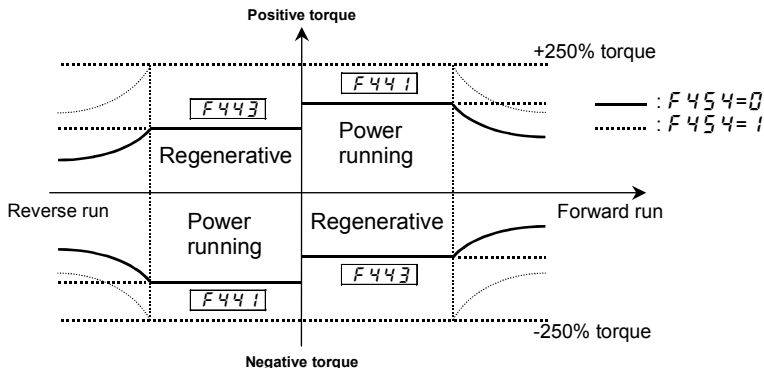

With the parameter $F454$, you can select the item that is limited in the constant output zone (somewhat weak magnetic field) from between constant output ($F454=0$: default setting) and constant torque ($F454=1$). When you select the constant torque limit option, you should preferably select the output voltage limit option ($F307=1$) with the parameter $F307$ (base frequency voltage selection).

Torque limits can be set with the parameters $F441$ and $F443$.

[Setting of power running torque]

$F441$ (Power running torque limit 1) : Set a desirable torque limit level.

[Setting of regenerative torque]

$F443$ (Regenerative braking torque limit 1) : Set a desirable torque limit level.

[Parameter setting]

Title	Function	Adjustment range	Default setting
$F441$	Power running torque limit 1 level	0.0-249.9 (%), 250.0: Disabled	250.0
$F443$	Regenerative braking torque limit 1 level	0.0-249.9 (%), 250.0: Disabled	250.0
$F454$	Constant output zone torque limit selection	0: Constant output limit 1: Constant torque limit	0

Using parameters, two different torque limits can be set for each operating status: power running and regenerative braking. Refer to Section 7.2.1 for the setting for switching from the terminal board.

Power running torque limit 1 – $F441$

Regenerative braking torque limit 1 – $F443$

Power running torque limit 2 – $F444$

Regenerative braking torque limit 2 – $F445$

Note: If the value set with $F501$ (stall prevention level) is smaller than the torque limit, then the value set with $F501$ acts as the torque limit.

6.22.2 Torque limit mode selection at acceleration/deceleration

$F451$: Acceleration/deceleration operation after torque limit

•Function

Using this function in combination with the mechanical brake of the lifting gear (such as a crane or hoist) makes it possible to minimize the delay before the brake starts working, and thus prevents the load from falling because of a decrease in torque.

Moreover, it improves the motor's response during inching operation and keeps the load from sliding down.

[Parameter setting]

Title	Function	Adjustment range	Default setting
$F451$	Acceleration/deceleration operation after torque limit	0: In sync with acceleration / deceleration 1: In sync with min. time	0

(1) $F451 = 0$ (In sync with acceleration/deceleration)

The increase in operation frequency is inhibited by the activation of the torque limit function. In this control mode, therefore, the actual speed is always kept in sync with the operation frequency. The operation frequency restarts to increase when torque decreases as a result of the release of the mechanical brake, so the time required for the specified speed to be reached is the sum of the delay in operation of the mechanical brake and the acceleration time.

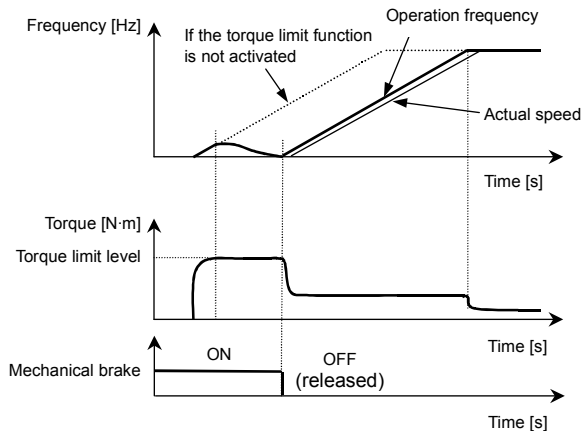

(2) F 4 5 $t := t$ (In sync with min. time)

The operation frequency keeps increasing, even if the torque limit function is activated.

In this control mode, the actual speed is kept in sync with the operation frequency, while torque is held at a limit level when it decreases as a result of the release of the mechanical brake. The use of this function prevents the load from failing and improves the motor's response during inching operation.

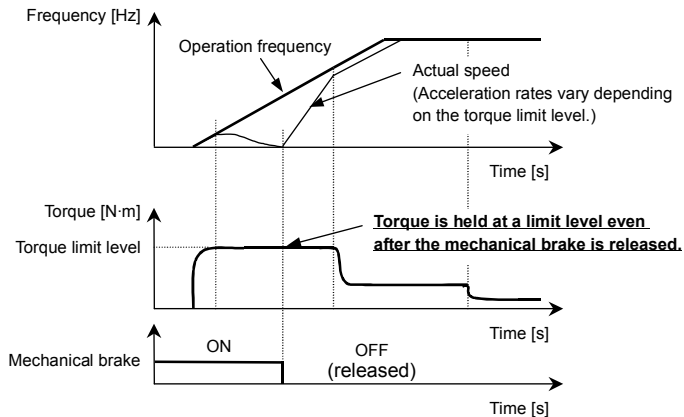

6.22.3 Power running stall continuous trip detection time

F452 : Power running stall continuous trip detection time

• **Function**

A function for preventing lifting gear from failing accidentally. If the stall prevention function is activated in succession, the inverter judges that the motor has stalled and trips.

[Parameter setting]

Title	Function	Adjustment range	Default setting
F452	Power running stall continuous trip detection time	0.01-10.0 (s)	0.00

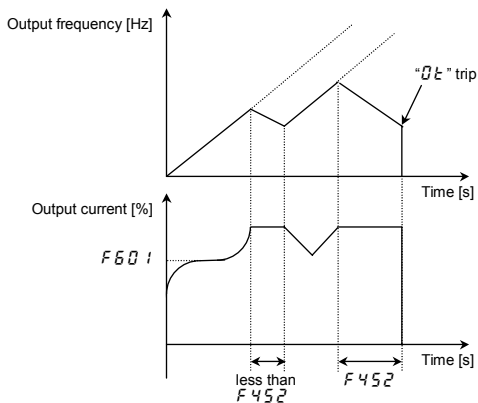

6.23 Acceleration/deceleration time 2 and 3

6.23.1 Selecting acceleration/deceleration patterns

F502: Acceleration/deceleration 1 pattern

F506: S-pattern lower-limit adjustment amount

F507: S-pattern upper-limit adjustment amount

- Function

These parameters allow you to select an acceleration/deceleration pattern that suits the intended use.

Title	Function	Adjustment range	Default setting
F502	Acceleration/ deceleration 1 pattern	0: Linear, 1: S-pattern 1, 2: S-pattern 2	0
F506	S-pattern lower-limit adjustment amount	0-50 (%)	10%
F507	S-pattern upper-limit adjustment amount	0-50 (%)	10%

1) Linear acceleration/deceleration

A general acceleration/ deceleration pattern. This pattern can usually be used.

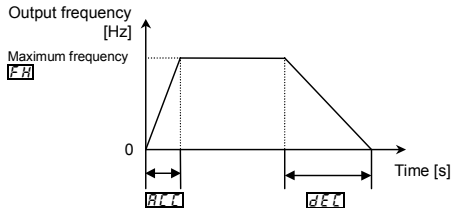

2) S-pattern 1 acceleration/deceleration

Select this pattern to accelerate/decelerate the motor rapidly to a high-speed region with an output frequency of 60Hz or more or to minimize the shocks applied during acceleration/deceleration. This pattern is suitable for pneumatic transport machines.

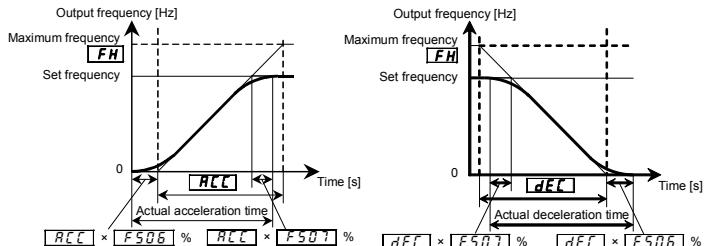

3) S-pattern 2 acceleration/deceleration

Select this pattern to obtain slow acceleration in a demagnetizing region with a small motor acceleration torque. This pattern is suitable for high-speed spindle operation.

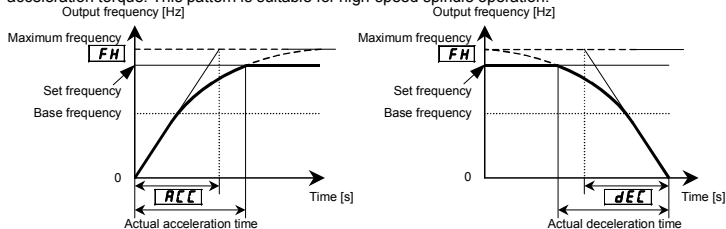

6.23.2 Switching of an acceleration/deceleration time 1, 2, 3

6

F500: Acceleration time 2

F501: Deceleration time 2

F503: Acceleration/deceleration 2 pattern

F504: Selecting an acceleration/deceleration pattern

F505: Acceleration/deceleration 1 and 2 switching frequency

F510: Acceleration time 3

F511: Deceleration time 3

F512: Acceleration/deceleration 3 pattern

F513: Acceleration/deceleration 2 and 3 switching frequency

F519: Setting of acceleration/deceleration time unit

- Function
 - Three acceleration times and three deceleration times can be specified individually. A method of selection or switching can be selected from among the following:
 - 1) Selection by means of parameters
 - 2) Switching by changing frequencies
 - 3) Switching by means of terminals

Title	Function	Adjustment range	Default setting
F500	Acceleration time 2	0.0-3600 (0.00-360.0) [sec]	10.0
F501	Deceleration time 2	0.0-3600 (0.00-360.0) [sec]	10.0
F504	Selecting an acceleration/deceleration pattern	1: Acceleration/deceleration 1 2: Acceleration/deceleration 2 3: Acceleration/deceleration 3	1
F510	Acceleration time 3	0.0-3600 (0.00-360.0) [sec]	10.0
F511	Deceleration time 3	0.0-3600 (0.00-360.0) [sec]	10.0
F519	Setting of acceleration/deceleration time unit	0: - 1: 0.01s unit (after execution: 0) 2: 0.1s unit (after execution: 0)	0

★ Default setting is 0.1s unit. Acceleration/deceleration time unit can be changed to 0.01s unit by F519=2 setting. The value of F519 return to 0 after setting.

1) Selection using parameters

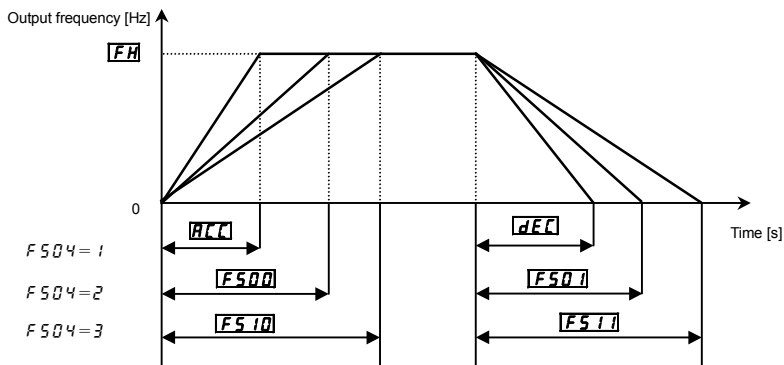

Acceleration/deceleration time 1 is initially set as the default. Acceleration/deceleration time 2 and 3 can be selected by changing the setting of the F504.

Enabled if CN0d = 1 (panel input enabled)

2) Switching by frequencies - Switching the acceleration/deceleration time automatically at the frequency setting of F505.

Title	Function	Adjustment range	Default setting
F505	Acceleration/deceleration 1 and 2 switching frequency	0.0-UL	0.0
F513	Acceleration/deceleration 2 and 3 switching frequency	0.0-UL	0.0

Note: Acceleration/deceleration patterns are changed from pattern 1 to pattern 2 and from pattern 2 to pattern 3 in increasing order of frequency, regardless of the order in which frequencies are changed. (For example, if F505 is larger than F513, F513 pattern 1 is selected in the frequency range below the frequency set with F505.)

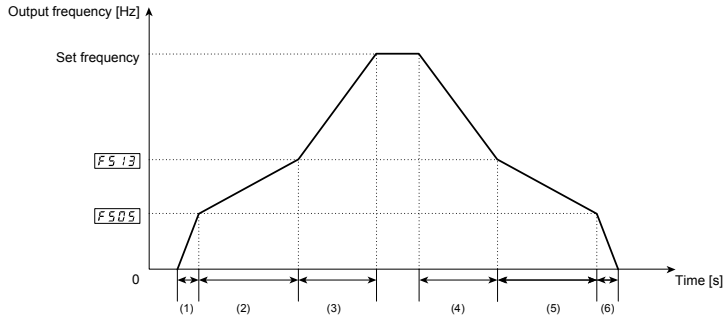

- | | |
|---|---|
| (1) Acceleration at the gradient corresponding to acceleration time $R C C$ | (4) Deceleration at the gradient corresponding to deceleration time $F S I I$ |
| (2) Acceleration at the gradient corresponding to acceleration time $F S O O$ | (5) Deceleration at the gradient corresponding to deceleration time $F S O I$ |
| (3) Acceleration at the gradient corresponding to acceleration time $F S I O$ | (6) Deceleration at the gradient corresponding to deceleration time $d E C$ |

3) Switching using external terminals - Switching the acceleration/deceleration time via external terminals

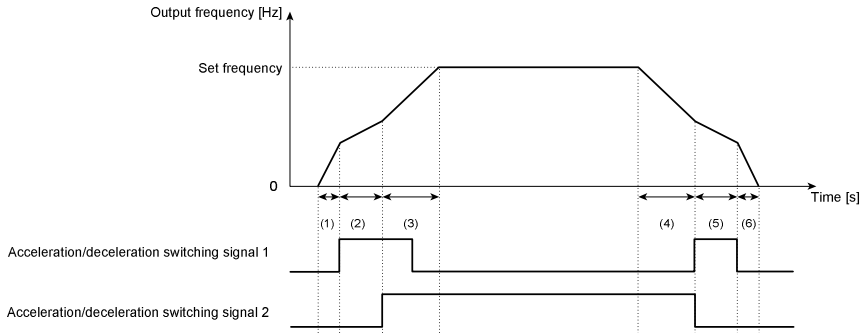

- | | |
|---|---|
| (1) Acceleration at the gradient corresponding to acceleration time $R C C$ | (4) Deceleration at the gradient corresponding to deceleration time $F S I I$ |
| (2) Acceleration at the gradient corresponding to acceleration time $F S O O$ | (5) Deceleration at the gradient corresponding to deceleration time $F S O I$ |
| (3) Acceleration at the gradient corresponding to acceleration time $F S I O$ | (6) Deceleration at the gradient corresponding to deceleration time $d E C$ |

6

■ How to set parameters

a) Operating method: Terminal input

Set the operation control mode selection $\overline{C} \overline{A} \overline{D}$ to $\overline{0}$.

b) Use the S2 and S3 terminals for switching. (Instead, other terminals may be used.)

S2: Acceleration/deceleration switching signal 1

S3: Acceleration/deceleration switching signal 2

Title	Function	Adjustment range	Setting value
$F 1 1 5$	Input terminal selection 5 (S2)	0-203	24 (the second acceleration/deceleration mode selection)
$F 1 1 6$	Input terminal selection 6 (S3)	0-203	26 (the third acceleration/deceleration mode selection)

■ Acceleration/ deceleration pattern

Acceleration/deceleration patterns can be selected individually, using the acceleration/deceleration 1, 2 and 3 parameters.

- 1) Linear acceleration/deceleration
- 2) S-pattern acceleration/deceleration 1
- 3) S-pattern acceleration/deceleration 2

Title	Function	Adjustment range	Setting value
$F 5 0 2$	Acceleration/ deceleration 1 pattern	0: Linear	0
$F 5 0 3$	Acceleration/ deceleration 2 pattern	1: S-pattern 1	0
$F 5 1 2$	Acceleration/ deceleration 3 pattern	2: S-pattern 2	0

★ For an explanation of acceleration/deceleration patterns, see 6.18.1.

★ Both the settings of the S-pattern lower-limit and upper-limit adjustment parameters ($F 5 0 6$ and $F 5 0 7$) are applied to any acceleration/deceleration S-pattern.

6.24 Protection functions

6.24.1 Setting motor electronic thermal protection

EHr: Motor electronic-thermal protection level 1

F173: Motor electronic-thermal protection level 2

F607: Motor 150% overload detection time

F632: Electronic-thermal memory

- Function

This parameter allows selection of the appropriate electronic thermal protection characteristics according to the particular rating and characteristics of the motor.

[Parameter setting]

Title	Function	Adjustment range	Default setting
EHr	Motor electronic-thermal protection level 1	10-100 (%) / (A)	100
F173	Motor electronic-thermal protection level 2	10-100 (%) / (A)	100
F607	Motor 150% overload detection time	10-2400 (s)	300
F632	Electrical-thermal memory	0: Disabled, 1: Enabled	0



Refer to section 3.5 for details.

Note 1: The 100% standard value is the rated output current indicated on the nameplate.

6.24.2 Setting of stall prevention level

F601: Stall prevention level 1

F185: Stall prevention level 2

 Caution	
 Prohibited	<ul style="list-style-type: none"> Do not set the stall prevention level (F601) extremely low. If the stall prevention level parameter (F601) is set at or below the no-load current of the motor, the stall preventive function will be always active and increase the frequency when it judges that regenerative braking is taking place. Do not set the stall prevention level parameter (F601) below 30% under normal use conditions.

- Function

This parameter adjusts the output frequency by activating a current stall prevention function against a current exceeding the **F601**-specified level.

[Parameter setting]

Title	Function	Adjustment range	Default setting
<i>F 601</i>	Stall prevention level 1	10-199 (%) / (A), 200: Disabled	150
<i>F 185</i>	Stall prevention level 2		

[Display during operation of the stall prevention]

During an \overline{OL} alarm status, (that is, when there is a current flow in excess of the stall prevention level), the output frequency changes. At the same time, to the left of this value, " \overline{L} " is displayed flashing on and off.

Example of display

- ★ The switching from *F 601* to *F 185* can be performed by entering a command through terminals. Refer to section 6.4.1 for details.

Note. The 100% standard value is the rated output current indicated on the nameplate.

6.24.3 Inverter trip retention

F 602: Inverter trip retention selection

- Function
If the inverter trips, this parameter will retain the corresponding trip information. Trip information that has thus been stored into memory can be displayed, even after power has been reset.

[Parameter setting]

Title	Function	Adjustment range	Default setting
<i>F 602</i>	Inverter trip retention selection	0: Cleared with power off 1: Retained with power off	0

- ★ The causes of up to eight trips that occurred in the past can be displayed in status monitor mode. (Refer to section 8.3)
- ★ Data displayed in status monitor mode when the inverter is tripped is cleared when power is turned off. Check the details monitor for the history of past trips. (Refer to section 8.2.2)
- ★ Trip records are retained even if power is turned off and turned back on during retry operation.

■ Flow of operation when $F515 = 1$

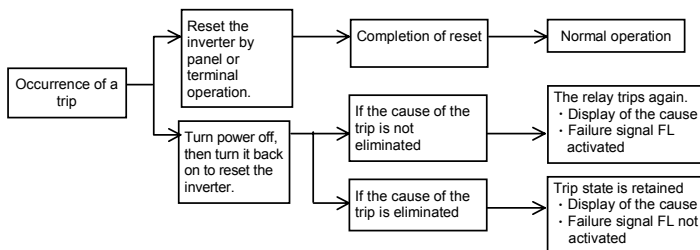

6.24.4 Emergency stop

F515: Deceleration time at emergency stop

F603: Emergency stop selection

F604: DC braking time during emergency stop

- Function
 - Set the stop method for an emergency. When operation stops, a trip occurs (E displays) and failure signal FL operates.
 - When **F603** is set to 2 (Emergency DC braking), set **F251** (DC braking amount) and **F604** (DC braking time during emergency stop).
 - When **F603** is set to 3 (Deceleration stop), set **F515** (Deceleration time at emergency stop).

1) Emergency stop from terminal

Emergency stop occurs at contact a or b. Follow the procedure below to assign a function to an input terminal and select a stop method.

[Parameter setting]

Title	Function	Adjustment range	Default setting
F515	Deceleration time at emergency stop	0.0-3600 (360.0) (s)	10.0
F603	Emergency stop selection	0: Coast stop 1: Deceleration stop 2: Emergency DC braking 3: Deceleration stop (F515) 4: Quick deceleration stop 5: Dynamic quick deceleration stop	0
F604	DC braking time during emergency stop	0.0-25.5 (s)	1.0
F251	DC braking current	0 ~ 100 (%)	50

Setting example) When assigning the emergency stop function to S2 terminal

Title	Function	Adjustment range	Setting
<i>F 1 1 4</i>	Input terminal selection 4A (S1)	0 - 203	20: EXT (Emergency stop by external signal)

Setting value 21 is reverse signal.

Note 1) Emergency stopping via the specified terminal is possible, even during panel operation.

2) Emergency stopping from the operation panel

Emergency stopping from the operation panel is possible

by pressing the STOP key on the panel twice while the inverter is not in the panel control mode.

- (1) Press the STOP key "*E 0 0 0*" will blink.
- (2) Press the STOP key once again Operation will come to a trip stop in accordance with the setting of the *F 6 0 3* parameter.
After this, "*E*" will be displayed and a failure detection signal generated (FL relay is activated).

Note: While an emergency stop signal is input at a terminal, the trip cannot be reset. Clear the signal and then reset the trip.

6.24.5 Output phase failure detection

6

F 6 0 5: Output phase failure detection selection

- Function
This parameter detects inverter output Phase failure. If the Phase failure status persists for one second or more, the tripping function and the FL relay will be activated. At the same time, a trip information *E P H 0* will also be displayed.
Set *F 6 0 5* to *5* to open the motor-inverter connection by switching commercial power operation to inverter operation.
Detection errors may occur for special motors such as high-speed motors.

F 6 0 5=*0*: No tripping (FL relay deactivated).

F 6 0 5=*1*: With the power on, the phase failure detection is enabled only at the start of the first operation.
The inverter will trip if the Phase failure status persists for one second or more.

F 6 0 5=*2*: The inverter checks for output phase failures each time it starts operation. The inverter will trip if the Phase failure status persists for one second or more.

F 6 0 5=*3*: The inverter checks for output phase failures during operation. The inverter will trip if the Phase failure status persists for one second or more.

F 6 0 5=*4*: The inverter checks for output phase failures at the start of and during operation. The inverter will trip if the Phase failure status persists for one second or more.

F 6 0 5=*5*: If it detects an all-phase failure, it will restart on completion of reconnection. The inverter does not check for output phase failures when restarting after a momentary power failure.

Note1) A check for output phase failures is made during auto-tuning, regardless of the setting of this parameter.

Note2) When parameter $P\ell = 5$ or ξ is selected, $F\zeta\zeta 5 = 3$ to 5 do not work.

[Parameter setting]

Title	Function	Adjustment range	Default setting
$F\zeta\zeta 5$	Output phase failure detection selection	0: Disabled 1: At start-up (only one time after power on) 2: At start-up (each time) 3: During operation 4: At start-up + during operation 5: Detection of cutoff on output side	0

6.24.6 Input phase failure detection

$F\zeta\zeta 8$: Input phase failure detection selection

- Function

This parameter detects inverter input Phase failure. If the abnormal voltage status of main circuit capacitor persists for few minutes or more, the tripping function and the FL relay will be activated. Trip display is $E\text{PH } i$. Detection may not be possible when operating with a light load, or when the motor capacity is smaller than the inverter capacity.

If the power capacity is larger than the inverter capacity (more than 200kVA or more than 10 times), detection errors may occur. If this actually happens, install an AC reactor.

$F\zeta\zeta 8 = 0$: No tripping (Failure signal FL not activated)

$F\zeta\zeta 8 = 1$: Phase failure detection is enabled during operation. The inverter will trip if the abnormal voltage status of main circuit capacitor persists for few minutes or more. (Failure signal FL activated)

[Parameter setting]

Title	Function	Adjustment range	Default setting
$F\zeta\zeta 8$	Input phase failure detection selection	0: Disabled 1: Enabled	1

Note1: Setting $F\zeta\zeta 8$ to 0 (input phase failure detection: disabled) may result in a breakage of the capacitor in the inverter main circuit if operation is continued under a heavy load in spite of the occurrence of an input phase failure.

Note2: Parameter $F\zeta\zeta 8$ is invalid for single-phase input model.

Note3: When operating the inverter with DC input, set $F\zeta\zeta 8 = 0$ (none).

6.24.7 Control mode for small current

F609: Small current detection hysteresis

F610: Small current trip/alarm selection

F611: Small current detection current

F612: Small current detection time

- Function

If the output current falls below the value set at **F611** and doesn't return above $F611 + F609$ for a time that exceeds the value set at **F612**, tripping or output alarm will be activated.

UC is displayed in the event of a trip.

F610=0: No tripping (Failure signal FL not activated).

A small current alarm can be put out by setting the output terminal function selection parameter.

F610=1: The inverter will trip (Failure signal FL activated) if a current below the current set with **F611** flows for the period of time specified with **F612**.

[Parameter setting]

Title	Function	Adjustment range	Default setting
F609	Small current detection hysteresis	1-20 (%)	10
F610	Small current trip/alarm selection	0: Alarm only 1: Tripping	0
F611	Small current detection current	0-150 (%) / (A)	0
F612	Small current detection time	0-255 (s)	0

<Example of operation>

Output terminal function: 26 (UC) Low current detection

F610=0 (Alarm only)

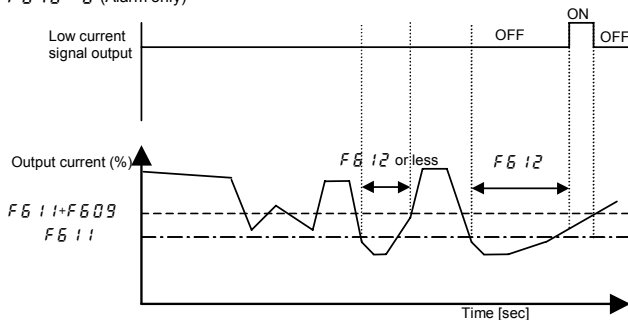

* When setting **F610** to 1 (Trip), trip after low current detection time setting of **F612**. After tripping, the low current signal remains ON.

6.24.8 Detection of output short-circuit

F613: Detection of output short-circuit at start-up

- Function
This parameter detects inverter output short-circuit. It can be usually detected in the length of the standard pulse. When operating low-impedance motor such as high-speed motor, however, select the short-time pulse.

F613=0: Detection is executed in the length of the standard pulse every time you start up the inverter.

F613=1: Detection is executed in the length of standard pulse only during the first start-up after putting on the power or after resetting.

F613=2: Detection is executed with the short-time pulse every time you start up the inverter.

F613=3: Detection is executed with the short-time pulse only for the first time after putting power on or after resetting.

[Parameter setting]

Title	Function	Adjustment range	Default setting
<i>F613</i>	Detection of output short-circuit at start-up	0: Each time (standard pulse) 1: Only one time after power on (standard pulse) 2: Each time (short pulse) 3: Only one time after power on (short pulse)	0

6.24.9 Over-torque trip

F615: Over-torque trip/alarm selection

F616: Over-torque detection level

F618: Over-torque detection time

F619: Over-torque detection hysteresis

- Function

If the torque value exceeds the value set at **F616** and doesn't return below **F616-F619** for a time that exceeds the value set at **F618**, tripping or output alarm will be activated.
OL is displayed in the event of a trip.

F615=0: No tripping (FL relay deactivated).

An over-torque alarm can be put out by setting the output terminal function selection parameter.

F615=1: The inverter is tripped (FL relay activated) only after a torque exceeding the **F616**-specified level has been detected for more than the **F618**-specified time.

[Parameter setting]

Title	Function	Adjustment range	Default setting
F615	Over-torque trip/alarm selection	0: Alarm only 1: Tripping	0
F616	Over-torque detection level	0 (disabled), 1-200 (%)	150
F618	Over-torque detection time	0.0-10.0 (s) Note	0.5
F619	Over-torque detection hysteresis	0-100 (%)	10

Note: **F618** = 0.0 seconds is the shortest time detected on control.

<Example of operation>

1) Output terminal function: 28 (OT) Over-torque detection

$F515=0$ (Alarm only)

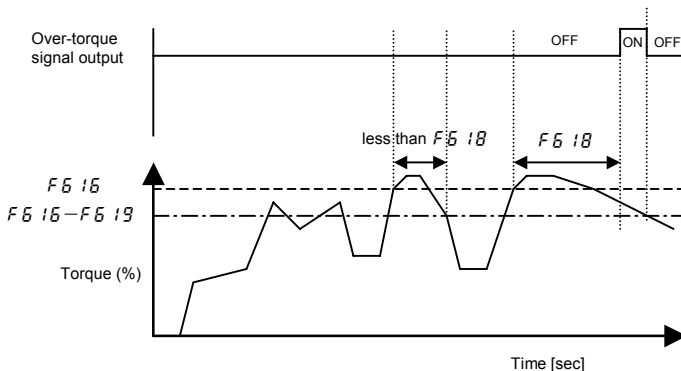

When $F515 = 1$ (tripping), the inverter will trip if over-torque lasts for the period of time set with $F518$. In such a case, the over-torque signal remains ON.

6.24.10 Cooling fan control selection

$F620$: Cooling fan ON/OFF control

- Function

Set to operate the fan only when the ambient temperature is high during operation. When the inverter is on, the service life of the cooling fan is longer than if it is always running.

$F620=0$: Cooling fan automatically controlled. Cooling fan operates only when the ambient temperature is high during operation.

$F620=1$: Cooling fan not automatically controlled. Fan is always running when the inverter is on.

★ If the ambient temperature is high, even when the inverter is stopped, the cooling fan automatically operates.

[Parameter setting]

Title	Function	Adjustment range	Default setting
$F620$	Cooling fan ON/OFF control	0: ON/OFF control, 1: Always ON	0

6.24.11 Cumulative operation time alarm setting

F621: Cumulative operation time alarm setting

- Function
This parameter allows you to set the inverter so that it will put out an alarm signal after a lapse of the cumulative operation time set with **F621**.

[Parameter setting]

Title	Function	Adjustment range	Default setting
F621	Cumulative operation time alarm setting	0.0-999.0 (100 hours)	876.0

★ "0.1" displayed on the monitor refers to 10 hours, and therefore "1.0" denotes 100 hours.

Ex.: 38.5 displayed on the monitor = 3850 (hours)

★ Monitor display of cumulative operation time alarm.

It can be confirmed in parts replacement alarm information of status monitor mode.

An example of display: **01111111**

★ Signal output of cumulative operation time alarm

Assign the cumulative operation time alarm function to any output terminal.

Ex.: When assigning the cumulative operation alarm signal output function to the OUT terminal

Title	Function	Adjustment range	Setting
F131	Output terminal selection 2A (OUT)	0-255	56: COT (Cumulative operation time alarm)

Setting value 57 is reverse signal.

6.24.12 Undervoltage trip

F627: Undervoltage trip/alarm selection

- Function
This parameter is used for selecting the control mode when an undervoltage is detected. Trip information is displayed as "**UP**".

F627=0: The inverter is stopped. However, it is not tripped (Failure signal FL not activated).

The inverter is stopped when the voltage does not exceed about 64 % of its rating.

F627=1: Inverter is stopped. It is also tripped (Failure signal FL activated), only after detection of a voltage not exceeding about 64% of its rating.

[Parameter setting]

Title	Function	Adjustment range	Default setting
F627	Undervoltage trip/alarm selection	0: Alarm only 1: Tripping 2: -	0

6.24.13 Analog input break detection

F633: Analog input break detection level (VIC)

F644: Operation selection of analog input break detection (VIC)

F649: Fallback frequency

- Function

The inverter will trip if the VIC value remains below the specified value for about 0.3 seconds. In such a case, trip "E-18" and alarm "RL05" is displayed.

F633=0: Disabled...Not detected.

F633=1-100...The inverter will trip if the VIC input remains below the specified value for about 0.3 seconds.

[Parameter setting]

Title	Function	Adjustment range	Default setting
F633	Analog input break detection level (VIC)	0: Disabled 1-100%	0
F644	Operation selection of analog input break detection (VIC)	0: Tripping 1: Alarm only (Coast stop) 2: Alarm only (F649 frequency) 3: Alarm only (Maintain running) 4: Alarm only (Deceleration stop)	0
F649	Fallback frequency	L-L-U-L	0.0

Note : The VIC input value may be judged earlier to be abnormal, depending on the degree of deviation of the analog data detected.

6.24.14 Parts replacement alarms

F634: Annual average ambient temperature (Parts replacement alarms)

- Function

You can set the inverter so that it will calculate the remaining useful lives of the cooling fan, main circuit capacitor and on-board capacitor from the ON time of the inverter, the operating time of the motor, the output current (load factor) and the setting of **F634**, and that it will display and send out an alarm through output terminals when each component is approaching the time of replacement.

[Parameter setting]

Title	Function	Adjustment range	Default setting
F634	Annual average ambient temperature (parts replacement alarms)	1: -10 to +10°C 2: 11-20°C 3: 21-30°C 4: 31-40°C 5: 41-50°C 6: 51-60°C	3

★ Display of part replacement alarm information

Part replacement alarm information (Refer to chapter 8) in the Status monitor mode allows you to check on the time of replacement.

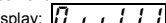
An example of display: 

★ Output of part replacement alarm signal

The parts replacement alarm is assigned to the output terminal.

Setup example) When the parts replacement alarm is assigned to the OUT terminal

Title	Function	Adjustment range	Setting
F 131	Output terminal selection 2A (OUT)	0-255	128: LTA (Parts replacement alarm)

Setting value 129 is reverse signal.

Note 1: Using F 534, enter the annual average temperature around the inverter. Be careful not to enter the annual highest temperature.

Note 2: Set F 534 at the time of installation of the inverter, and do not change its setting after the start of use. Changing the setting may cause parts replacement alarm calculation error.

6.24.15 Motor PTC thermal protection

F 147: Logic input / PTC input selection (S3)

F 545: PTC thermal selection

F 546: Resistor value for PTC detection

- Function
This function is used to protect motor from overheating using the signal of PTC built-in motor.
The trip display is "E - 32".

[Parameter setting]

Title	Function	Adjustment range	Default setting
F 147	Logic input / PTC input selection (S3)	0: Logic input 1: PTC input	0
F 545	PTC thermal selection	0: Tripping 1: Alarm only	1
F 546	PTC detection resistor value	100-9999 (Ω)	3000

Note : Protecting PTC thermal, set F 147 = 1 (PTC input) and slide switch SW2 to PTC side.

★ Tripping level is defined by F 545 setting. Alarm level is defined by 60% of F 546 setting.

★ Connect the PTC of PT100 characteristic between S3 and CC terminals.

Detection temperature can be set by F 546 setting.

[Connection]

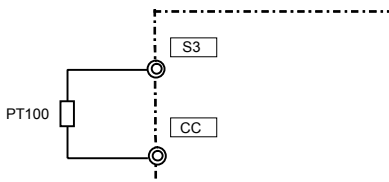

★ Output of PTC input alarm signal

The PTC input alarm is assigned to the output terminal.

Setup example) When the PTC input alarm is assigned to the OUT terminal

Title	Function	Adjustment range	Setting
F 13 1	Output terminal selection 2A (OUT)	0-255	150: PTCA (PTC input alarm signal)

Setting value 151 is reverse signal.

6.24.16 Number of starting alarm

F 5 4 8: Number of starting alarm

- Function
Counting the number of starting, when it will reach the value of parameter **F 5 4 8** setting, it will be displayed and alarm signal is output.

[Parameter setting]

Title	Function	Adjustment range	Default setting
F 5 4 8	Number of starting alarm	0.0-999.0 (10000 times)	999.0

★ "0.1" displayed on the monitor refers to 1000 times, and therefore "1.0" denotes 10000 times.

Ex.: 38.5 displayed on the monitor = 385000 (times)

★ Display of number of starting alarm information

Number of starting alarm information (Refer to chapter 8) in the Status monitor mode allows you to check on the time of replacement.

An example of display: 

★ Output of number of starting alarm signal

The number of starting alarm is assigned to the output terminal.

Setup example) When the number of starting alarm is assigned to the OUT terminal

Title	Function	Adjustment range	Setting
F 13 1	Output terminal selection 2A (OUT)	0-255	162: NSA (Number of starting alarm)

Setting value 163 is reverse signal.

6.25 Forced fire-speed control function

F650: Forced fire-speed control selection

F294: Preset-speed frequency 15

- Function

Forced fire-speed control is used when operating the motor at the specified frequency in case of an emergency. Two kind of operation are selectable by assignment of terminal board function.

(1) Input terminal function 56 (FORCE) : Input signal is kept to hold once signal is ON.

Motor runs at the speed set by the parameter "F294".

Motor does not stop as possible as when the trip is occurred.

Note: This case needs to power off in order to stop

(2) Input terminal function 58 (FIRE) : Input signal is kept to hold once signal is ON.

Motor runs at the speed set by the parameter "F294".

Note: This case needs to power off or input terminal function (emergency stop) in order to stop.

[Parameter setting]

Title	Function	Adjustment range	Default setting
F650	Forced fire-speed control selection	0: Disabled 1: Enabled	0
F294	Preset-speed frequency 15	LL - UL (Hz)	0.0

[Setup example of the forced operation input terminal]

The terminal "RES" shall be assigned.

Title	Function	Adjustment range	Setting value
F113	Input terminal selection 3A (RES)	0 - 203	56 (Forced run operation)
F113	Input terminal selection 3A (RES)	0 - 203	58 (Fire speed operation)

Each setting value 57, 59 are reverse signal.

★ "F1rE" and output frequency are blinking during forced run operation and fire-speed operation.

6.26 Override

F205 : VIA input point 1 rate

F206 : VIA input point 2 rate

F214 : VIB input point 1 rate

F215 : VIB input point 2 rate

F220 : VIC input point 1 rate

F221 : VIC input point 2 rate

F660 : Override addition input selection

F661 : Override multiplication input selection

F729 : Operation panel override multiplication gain

• **Function**

These parameters are used to adjust reference frequencies by means of external input.

[Parameter setting]

Title	Function	Adjustment range	Default setting
F205	VIA input point 1 rate	0-250 (%)	0
F206	VIA input point 2 rate	0-250 (%)	100
F214	VIB input point 1 rate	-250+250 (%)	0
F215	VIB input point 2 rate	-250+250 (%)	100
F220	VIC input point 1 rate	0-250 (%)	0
F221	VIC input point 2 rate	0-250 (%)	100
F660	Override addition input selection [Hz]	0: Disabled 1: VIA 2: VIB 3: VIC 4: F729	0
F661	Override multiplication input selection [%]	0: Disabled 1: VIA 2: VIB 3: VIC 4: F729	0
F729	Operation panel override multiplication gain	-100+100 (%)	0

The override functions calculate output frequency by the following expression:

$$\text{Frequency command value} \times \left(1 + \frac{\text{Value [\%] selected with } F \bar{5} \bar{5} \bar{1}}{100}\right) + \text{Value [Hz] selected with } F \bar{5} \bar{5} \bar{0}$$

1) Additive override

In this mode, an externally input override frequency is added to operation frequency command.

[Ex.1: VIA (Reference frequency), VIC (Override input)] [Ex.2: VIB (Reference frequency), VIA (Override input)]

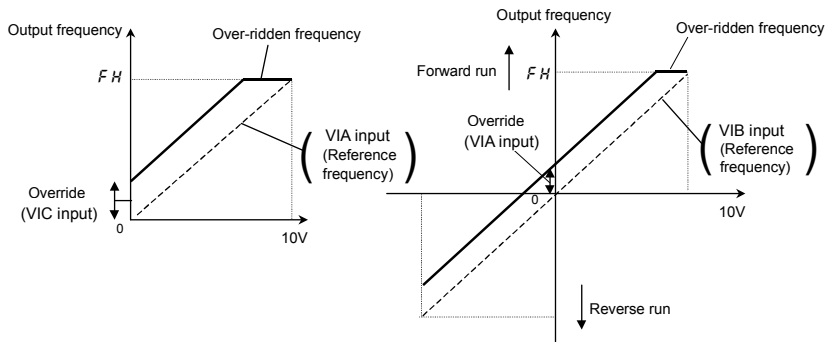

Ex.1:

$F \bar{5} \bar{5} \bar{0} = 3$ (VIC input), $F \bar{5} \bar{5} \bar{1} = 0$ (disabled)

Output frequency = Reference frequency + Override (VIC input [Hz])

Ex.2:

$F \bar{5} \bar{5} \bar{0} = 1$ (VIA input), $F \bar{5} \bar{5} \bar{1} = 0$ (disabled)

Output frequency = Reference frequency + Override (VIA input [Hz])

2) Multiplicative override

In this mode, each output frequency is multiplied by an externally override frequency.

[Ex.1: VIA (Reference frequency), VIC (Override input)] [Ex.2: VIB (Reference frequency), VIA (Override input)]

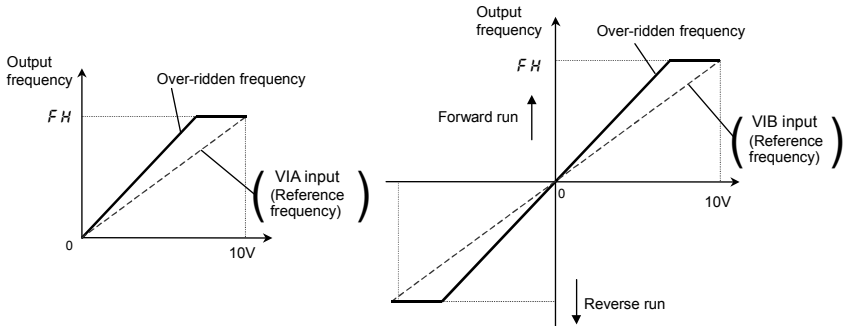

Ex.1:

$F660=0$ (Disabled), $F661=3$ (VIC input), $F00d=1$ (VIA input), $FH=800$, $UL=800$

VIA input, ($F201=0$, $F202=00$, $F203=100$, $F204=800$)

VIC input ($F216=0$, $F220=0$, $F218=100$, $F221=100$)

⇒ Setting of VIA input: Refer to Section 7.3.1, Setting of VIC input: Refer to Section 7.3.2.

$$\text{Output frequency} = \text{Reference frequency} \times \{1 + \text{Override (VIC input [\%]/100)}\}$$

Ex.2:

$F660=0$ (Disabled), $F661=1$ (VIA input), $F00d=2$ (VIB input), $FH=800$, $UL=800$

VIB input ($F210=0$, $F211=00$, $F212=100$, $F213=800$)

VIA input ($F201=0$, $F205=0$, $F203=100$, $F206=100$)

⇒ Setting of VIB input: Refer to Section 7.3.3, Setting of VIA input: Refer to Section 7.3.1.

$$\text{Output frequency} = \text{Reference frequency} \times \{1 + \text{Override (VIA input [\%]/100)}\}$$

Ex.3:

Title	Function	Adjustment range	Default setting
$F729$	Operation panel override multiplication gain	-100~100%	0

$$\text{Output frequency} = \text{Reference frequency} \times \{1 + \text{Override (} F729 \text{ setting value [\%]/100)}\}$$

6.27 Analog input terminal function selection

F214 : VIB input point 1 rate

F215 : VIB input point 2 rate

F663 : Analog input terminal function selection (VIB)

• Function

Parameter inputting is normally set from operation panel. However some parameters can be continuously set from external analog input by using this function.

[Parameter setting]

Title	Function	Adjustment range	Default setting
F214	VIB input point 1 rate	-250-+250 (%)	0
F215	VIB input point 2 rate	-250-+250 (%)	100
F663	Analog input terminal function selection	0: Frequency command 1: Acceleration/deceleration time 2: Upper limit frequency 3, 4: - 5: Torque boost value 6: Stall prevention level 7: Motor electronic-thermal protection level 8 to 10: - 11: Base frequency	0

★ VIB terminal can be assigned analog input terminal function. The range of analog input voltage is 0% to +100%. From -100% to 0% cannot be used.

★ The parameter that is selected by **F663** can be adjusted range as following table.

Setting of F663	Object parameter	VIB : 0% input	VIB : 100% input
0: Frequency command	-	-	-
1: Acceleration/ deceleration time	<i>RCC, DEC, F500, F501, F510, F511</i>	Parameter setting value x <i>F214</i>	Parameter setting value x <i>F215</i>
2: Upper limit frequency	<i>UL</i>	Parameter setting value x <i>F214</i>	Parameter setting value x <i>F215</i>
5: Torque boost value	<i>ub, F172</i>	Parameter setting value x <i>F214</i>	Parameter setting value x <i>F215</i>
6: Stall prevention level	<i>F185, F601</i>	Parameter setting value x <i>F214</i>	Parameter setting value x <i>F215</i>
7: Motor electronic-thermal protection level	<i>thr, F173</i>	Parameter setting value x <i>F214</i>	Parameter setting value x <i>F215</i>
11: Base frequency	<i>ULU, F171</i>	Parameter setting value x <i>F214</i>	Parameter setting value x <i>F215</i>

Note: Adjustments are made by the inverter itself, so no changes are made to parameter settings

6.28 Adjustment parameters

6.28.1 Pulse train output for meters

F559: Logic output/pulse train output selection (OUT)

F575: Pulse train output function selection (OUT)

F577: Maximum numbers of pulse train output

F578: Pulse train output filter

- Function

Pulse trains can be sent out through the OUT output terminals.

To do so, it is necessary to select a pulse output mode and specify the number of pulses.

Ex.: When operations frequencies (0 to 60Hz) are put out by means of 0 to 600 pulses

$FH=60.0$, $F559=1$, $F575=0$, $F577=0.60$

[Parameter setting]

Title	Function	Adjustment range	Reference of maximum value of $F577$	Default setting
F559	Logic output/pulse train output selection (OUT)	0: Logic output 1: Pulse train output	-	0
F575	Pulse train output function selection (OUT)	0: Output frequency 1: Output current 2: Frequency reference 3: Input voltage (DC detection) 4: Output voltage (command value) 5: Input power 6: Output power 7: Torque 8: - 9: Motor cumulative load factor 10: Inverter cumulative load factor 11: PBR (Braking resistor) cumulative load factor 12: Frequency setting value (after compensation) 13: VIA input value 14: VIB input value 15: Fixed output 1 (output current 100% equivalent) 16: Fixed output 2 (output current 50% equivalent) 17: Fixed output 3 (Other than the output current) 18: Communication data 19: - 20: VIC input value 21, 22: - 23: PID feedback value	FH 185% FH 150% 150% 185% 185% 250% - 100% 100% 100% FH 10 V 10 V 185% 185% 100% 100.0% - 20mA - 100%	0

Title	Function	Adjustment range	Reference of maximum value of $F577$	Default setting
$F577$	Maximum numbers of pulse train	0.50-2.00 (kpps)	—	0.80
$F578$	Pulse train output filter	4-1000 (ms)	—	64

- ★ Digital panel meter for reference
 Type: K3MA-F (OMRON)
 Connection terminal: OUT-E4, NO-E5

Note 1: When item of $F578$ reaches "Reference of max. value", the number of pulse train set by $F577$ are sent to output terminals (OUT)

Note 2: The ON pulse width is maintained constant.

The ON pulse width is fixed at a width that causes the duty to reach 50% at the maximum pulse number set with $F577$.

Therefore, the duty is variable.

For example, the ON pulse width is approximately 0.6 ms when $F577=0.80$,
 approximately 0.5 ms when $F577=1.00$,
 approximately 0.3 ms when $F577=1.60$.

Note 3: The minimum pulse output rate is 10pps. Keep in mind that no pulses can be put out at any rate smaller than this.

Note 4: $F578 = 12$ is the motor drive frequency.

6

6.28.2 Calibration of analog output

$F681$: Analog output signal selection

$F684$: Analog output filter

$F691$: Inclination characteristic of analog output

$F692$: Analog output bias

- Function

Output signal from the FM terminal can be switched between 0 to 1mAdc output, 0 to 20mAdc output, and 0 to 10Vdc output with the $F681$ setting. The standard setting is 0 to 1mAdc output.

* Optional frequency meter: When using QS60T, set $F681=0$ (meter option (0 to 1mA) output).

[Parameter setting]

Title	Function	Adjustment range	Default setting
$F681$	Analog output signal selection	0: Meter option (0 to 1mA) 1: Current (0 to 20mA) output 2: Voltage (0 to 10V) output	0
$F684$	Analog output filter	4-1000 (ms)	4
$F691$	Inclination characteristic of analog output	0: Negative inclination (downward slope) 1: Positive inclination (upward slope)	1
$F692$	Analog output bias	-1.0 - +100.0 (%)	0

Note 1: With 0 to 20mA_{d.c.} (4 to 20mA_{d.c.}) output, or 0 to 10V_{d.c.} output, set $F681$ to 1 or 2.

■ Example of setting

$F681=1, F691=1, F692=0(\%)$

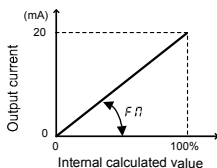

$F681=1, F691=1, F692=20(\%)$

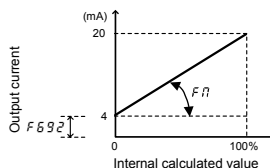

$F681=1, F691=0, F692=100(\%)$

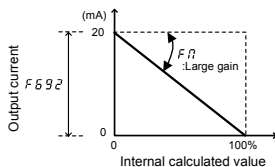

$F681=1, F691=0, F692=100(\%)$

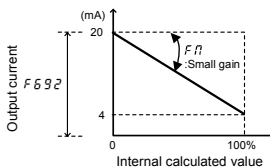

★ The analog output inclination can be adjusted using the parameter $F691$.

6.29 Operation panel parameter

6.29.1 Prohibition of key operations and parameter settings

F700: Parameter protection selection

F730: Panel frequency setting prohibition (FL)

F731: Disconnection detection of remote keypad

F732: Local/remote key prohibition of remote keypad

F733: Panel operation prohibition (RUN key)

F734: Panel emergency stop operation prohibition

F735: Panel reset operation prohibition

F736: $CNOdIFNOd$ change prohibition during operation

F737: All key operation prohibition

F738: Password setting (F700)

F739: Password verification

- **Function**
These parameters allow you to prohibit or allow operation of the RUN and STOP keys on the operation panel and the change of parameters. Using these parameters, you can also prohibit various key operations. Lock parameters with a password to prevent configuration.

(Parameter setting)

Title	Function	Adjustment range	Default setting
F700	Parameter protection selection	0: Permitted 1: Writing prohibited (Panel and remote keypad) 2: Writing prohibited (1 + RS485 communication) 3: Reading prohibited (Panel and remote keypad) 4: Reading prohibited (3 + RS485 communication)	0
F730	Panel frequency setting prohibition (FL)	0: Permitted, 1: Prohibited	0
F731	Disconnection detection of remote keypad	0: Permitted, 1: Prohibited	0
F732	Local/remote key prohibition of remote keypad	0: Permitted, 1: Prohibited	1
F733	Panel operation prohibition (RUN key)	0: Permitted, 1: Prohibited	0

Title	Function	Adjustment range	Default setting
F 734	Panel emergency stop operation prohibition	0: Permitted, 1: Prohibited	0
F 735	Panel reset operation prohibition	0: Permitted, 1: Prohibited	0
F 736	LRd / FRd change prohibition during operation	0: Permitted, 1: Prohibited	1
F 737	All key operation prohibition	0: Permitted, 1: Prohibited	0
F 738	Password setting (F 700)	0: Password unset 1-9998 9999: Password set	0
F 739	Password verification	0: Password unset 1-9998 9999: Password set	0

★ Assigning the parameter editing permission (function number 110, 111) to any logic input terminal, parameters can be written regardless of the setting of F 700.

Note1: F 700=2 and 4 will be available after reset operation.

When protection using a password is necessary, set and remove with the following method.

6 Password setup method

Preparation: Parameters other than F 700, F 738, and F 739 cannot be changed when F 700 is set to 1 to 4.

- When F 738 or F 739 are read out and the value is 0, a password is not set. A password can be set.
- When F 738 or F 739 are read out and the value is 9999, a password is already set.
- If a password is not set, one can be set. Select and register a value between 1 and 9998 for F 738. The number becomes the password. It must be entered to remove the password, so do not forget it.
- The settings for parameter F 700 cannot be changed.

Note2: Password cannot be set when parameter F 700=0 setting.

Set the password after parameter F 700=1 to 4 setting.

Note3: If you forget the password, it cannot be removed. Do not forget this password as we cannot retrieve it.

6 Password examination method

- When F 738 or F 739 are read out and the value is 9999, a password is set. Changing the parameter requires removing the password.
- Enter a number (1 to 9998) registered to F 738 when the password was set for F 739.
- If the password matches, PRS blinks on the display and the password is removed.
- If the password is incorrect, FRIL blinks on the display and F 739 is displayed again.
- When the password is removed, the setting for parameter F 700 can be changed.
- By setting parameter F 700=0, the settings of all parameters can be changed.

Note4: Password examination operation cannot be continued after 3 times failure.

To be continued, power supply is switched OFF and ON.

When protecting a parameter is necessary with the external logic input terminal, set with the following method.

■ Prohibit changing parameters settings and reading parameters from logic input

Set "Parameter editing prohibition" or "Parameter reading/editing prohibition" for any input terminal.

Activating the "Parameter editing prohibited" function prevents changes to parameters.

Activating the "Parameter reading/editing prohibition" function prevents reads and writes to parameters.

The following table shows an example of setting input terminal S1 and S2.

Title	Function	Adjustment range	Setting
<i>F 1 14</i>	Input terminal selection 4A (S1)	0-203	200: PWP (Parameter editing prohibition)
<i>F 1 15</i>	Input terminal selection 5 (S2)	0-203	202: PRWP (Parameter reading prohibition)

Setting value 201, 203 are reverse signal.

6.29.2 Changing the unit (A/V) from a percentage of current and voltage

F701: Current/voltage unit selection

- Function

These parameters are used to change the unit of monitor display.

% \leftrightarrow A (ampere)/V (volt)

Current 100% = Rated current of inverter

Input/output voltage 100% = 200Vac (240V class), 400Vac (500V class)

Example of setting

During the operation of the VFMB1S-2015PL (rated current: 8.0A) at the rated load (100% load), units are displayed as follows:

1) Display in percentage terms

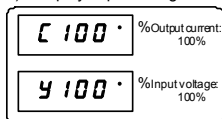

2) Display in amperes/volts

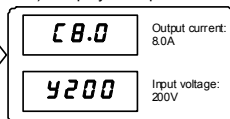

[Parameter setting]

Title	Function	Adjustment range	Default setting
F701	Current/voltage unit selection	0: % 1: A (ampere) / V (volt)	0

- * The **F701** converts the following parameter settings:

- A display : Current monitor display: Load current, torque current

Motor electronic-thermal protection level 1 & 2 **LHr, F173**

DC braking current **F251**

Stall prevention level 1 & 2 **F501, F185**

Small current detection current **F511**

- V display : Input voltage, output voltage

Note) Base frequency voltage 1 & 2 (**ULv, F171**) always displayed in the unit of V.

6.29.3 Displaying the motor or the line speed

F702: Frequency free unit display magnification

F703: Frequency free unit coverage selection

F705: Inclination characteristic of free unit display

F706: Free unit display bias

- Function

The frequency or any other item displayed on the monitor can be converted freely into the rotational speed of the motor, the operating speed of the load, and so on.

Using these parameters, the units of the amounts of processing and feedback in PID control can also be changed.

The value obtained by multiplying the displayed frequency by the **F702**-set value will be displayed as follows:

$$\text{Value displayed} = \text{Monitor-displayed or parameter-set frequency} \times \text{F702}$$

1) Displaying the motor speed

To switch the display mode from 60Hz (default setting) to 1800min⁻¹ (the rotating speed of the 4P motor)

$$\begin{array}{ccc} \boxed{60.0} \text{ Hz} & \longrightarrow & \boxed{1800} \\ \text{F702} = 0.00 & & \begin{array}{l} \text{F702} = 30.00 \\ 60 \times 30.00 = 1800 \end{array} \end{array}$$

2) Displaying the speed of the loading unit

To switch the display mode from 60Hz (default setting) to 6m/min⁻¹ (the speed of the conveyer)

$$\begin{array}{ccc} \boxed{60.0} \text{ Hz} & \longrightarrow & \boxed{6.00} \\ \text{F702} = 0.10 & & \begin{array}{l} \text{F702} = 0.10 \\ 60 \times 0.10 = 6.00 \end{array} \end{array}$$

Note: This parameter displays the inverter output frequency as the value obtained by multiplying it by a positive number. This does not mean that the actual motor speed or line speed are indicated with accuracy.

[Parameter setting]

Title	Function	Adjustment range	Default setting
<i>F 702</i>	Frequency free unit display magnification	0.00: Disabled (display of frequency) 0.01-200.0 (times)	0.00
<i>F 703</i>	Frequency free unit coverage selection	0: All frequencies display 1: PID frequencies display	0
<i>F 705</i>	Inclination characteristic of free unit display	0: Negative inclination (downward slope) 1: Positive inclination (upward slope)	1
<i>F 706</i>	Free unit display bias	0.00- <i>FH</i> (Hz)	0.00

* The *F 702* converts the following parameter settings:

In case of *F 703=0*

- Free unit Frequency monitor display

Operation frequency command, Operation frequency, PID feedback, Frequency command value After correction, Operation frequency command at trip

Frequency-related parameters

FC, FH, UL, LL, Sr 1 ~ Sr 7, F 100, F 101, F 102, F 167, F 190, F 192, F 194, F 196, F 198, F 202, F 204, F 211, F 213, F 217, F 219, F 240, F 241, F 242, F 250, F 260, F 265, F 267, F 268, F 270 to F 275, F 287 ~ F 294, F 330, F 331, F 346, F 350, F 367, F 368, F 383, F 390 to F 393, F 505, F 513, F 649, F 812, F 814, R 923 to R 927

In case of *F 703=1*

- Free unit PID control -related parameters *FP 1d, F 367, F 368*

■ An example of setting when *FH* is 80 and *F 702* is 10.00

F 705=1, F 706=0.00

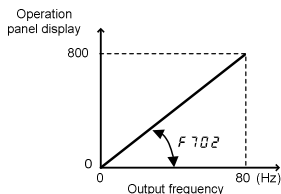

F 705=1, F 706=20.00

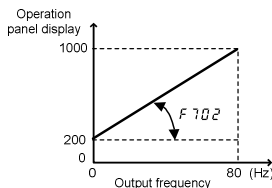

$$F705=0, F706=80.00$$

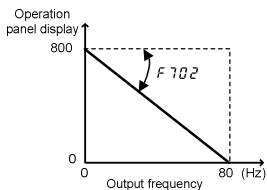

6.29.4 Changing the steps in which the value increment

F707: Free step (1-step rotation of setting dial)

F708: Free step 2 (panel display)

- Function

It is possible to change the step width changed at panel frequency setting.

This function is useful when only running with frequencies of intervals of 1 Hz, 5 Hz, and 10 Hz units.

Note 1: The settings of these parameters have no effect when the free unit selection ($F702$) is enabled.

Note 2: Set $F707$ to other than 0. When increasing the frequency by turning the setting dial right and if UL (Upper limit frequency) is exceeded by rotating 1 step more, the $H!$ alarm displays before this happens and the frequency cannot be increased beyond this point.

Similarly, when decreasing the frequency by turning the setting dial left and if the rotating 1 step more lowers it below LL (lower limit frequency), the $L!$ alarm displays before this happens and the frequency cannot be lowered beyond this point.

■ When $F707$ is not 0.00, and $F708 = 0$ (disabled)

Under normal conditions, the frequency command value from the operation panel increases in steps of 0.1 Hz each time you turn the setting dial right 1 step. If $F707$ is not 0.00, the frequency command value will increase by the value with $F707$ each time you turn the setting dial right 1 step. Similarly, it will decrease by the value set with $F707$ each time you turn the setting dial left 1 step.

In this case, the output frequency displayed in standard monitor mode changes in steps of 0.1 Hz, as usual.

■ When $F707$ is not 0.00, and $F708$ is not 0

The value displayed on the panel also can also be changed in steps.

$$\boxed{\text{Output frequency displayed in standard monitor mode}} = \boxed{\text{Internal output frequency}} \times \frac{F708}{F707}$$

[Parameter setting]

Title	Function	Adjustment range	Default setting
$F\ 707$	Free step (1-step rotation of setting dial)	0.00: Disabled 0.01- $F\ H$ (Hz)	0.00
$F\ 708$	Free step 2 (panel display)	0: Disabled 1-255	0

■ Operation example 1

$F\ 707 = 0.00$ (disabled)

By rotating the setting dial 1 step, the panel frequency command value changes only 0.1 Hz.

When $F\ 707 = 10.00$ (Hz) is set

Rotating the setting dial 1 step changes the panel frequency command value in 10.00 Hz increments, from 0.00 up to 60.00 (Hz).

■ Operation example 2

When $F\ 707 = 1.00$ (Hz), and $F\ 708 = 1$:

By rotating the setting dial 1 step, the frequency setting $F\ \bar{C}$ changes in steps of 1Hz: 0 → 1 → 2 → ... → 60 (Hz) and also the value displayed on the operation panel changes in steps of 1. Use these settings to hide decimal fractions and also the value displayed on the operation panel changes in steps of 1. Use these settings to hide decimal fractions.

6

6.29.5 Changing the initial display of the panel

$F\ 710$: Initial panel display selection

$F\ 720$: Initial remote keypad display selection

- Function
This parameter specifies display format while power is ON.

■ Changing the display format while power is ON

When the power is ON, the standard monitor mode displays the operation frequency (default setting) in the format of " $\bar{G}.\bar{G}$ " or " $\bar{G}\bar{F}\bar{F}$ ". This format can be changed to any other monitor display format by setting $F\ 710$. This new format, however, will not display an assigned prefix such as \bar{L} or \bar{C} . When the power is ON, the display of the extension panel is set at $F\ 720$.

★ When the power is ON, the main panel and the remote keypad can be set to display differently.

[Parameter setting]

Title	Function	Adjustment range	Default setting
F 7 10	Initial panel display selection	0: Operation frequency (Hz/free unit) 1: Output current (%/A) 2: Frequency setting value (Hz/free unit) 3: Input voltage (DC detection) (%/V) 4: Output voltage (command value) (%/V) 5: Input power (kW) 6: Output power (kW) 7: Torque (%) 8: - 9: Motor cumulative load factor 10: Inverter cumulative load factor 11: PBR (Braking resistor) cumulative load factor 12: Frequency setting value (after compensation) (Hz/free unit) 13: VIA input value (%) 14: VIB input value (%) 15 to 17: - 18: Arbitrary code from communication 19: - 20: VIC input value (%) 21: Pulse train input value (kpps) 22: -	0
F 7 20	Initial remote keypad display selection	23: PID feedback value (Hz/free unit) 24: Input power (kWh) 25: Output power (kWh) 26: Motor load factor (%) 27: Drive load factor (%) 28: Drive rated current (A) 29: FM output value (%) 30: Pulse train output value (kpps) 31: Cumulative power on time (100 hours) 32: Cumulative fan operation time (100 hours) 33: Cumulative operation time (100 hours) 34: Number of starting (10000 times) 35: Forward number of starting (10000 times) 36: Reverse number of starting (10000 times) 37 to 39: - 40: Inverter rated current (Carrier frequency corrected) 41 to 51: -	0

★ For details on F 7 10 / F 7 20 = 18, see the Communications Function Instruction Manual.

Note: If F 7 20 = 18 setting, fixed value is displayed.

6.29.6 Changing display of the status monitor

F711 to **F718**: Status monitor 1 to 8

Change monitor display items in the status monitor mode.

⇒ Refer to chapter 8 for details.

6.29.7 Changing the status monitor condition

F709: Standard monitor hold function

F745: Status monitor filter

- Function
The standard monitor display can be hold.
And a part of status monitors can be filtered to display.

☆ If **F709** is set to **0**, the monitored values selected with **F710** (standard monitor display selection parameter) are displayed one after another. For peak hold values and minimum hold values, the minimum values in each operation mode are displayed. When the motor is at a standstill, the values monitored last are held as they were until the motor is started the next time.

The maximum and minimum values monitored after power is turned on or after the reset with the EASY key are always displayed no matter whether the motor is in operation or at a standstill.

☆ "Output current", "Input voltage", "Output voltage" and "Torque" can be filtered.

⇒ Refer to chapter 8 about status monitor.

[Parameter setting]

Title	Function	Adjustment range	Default setting
F709	Standard monitor hold function	0: Real time 1: Peak hold 2: Minimum hold	0
F745	Status monitor filter	8-1000 (ms)	200

6.29.8 Canceling the operation command

F719: Canceling of operation command when standby terminal (ST) is turned off

- **Function**
When the standby (ST) terminal is turned off during panel operation, the inverter will restart operation if the ST terminal is turned back on. Using this parameter, you can also set the inverter so that, even if the ST is turned back on, it will not restart operation until you press the RUN key.

[Parameter setting]

Title	Function	Adjustment range	Default setting
F719	Canceling of operation command when standby terminal (ST) is turned off	0: Operation command canceled (cleared) 1: Operation command retained	1

6.29.9 Selection of operation panel stop pattern

F721: Selection of operation panel stop pattern

- **Function**
This parameter are used to select a mode in which the motor started by pressing the **(RUN)** key on the operation panel is stopped when the **(STOP)** key is pressed.

- 1) **Deceleration stop**
The motor slows down to a stop in the deceleration time set with *dEC* (or *F501* or *F511*).
- 2) **Coast stop**
The inverter cuts off power supply to the motor. The motor comes to a stop after coasting for a while by inertia. Depending on the load, the motor may keep running for a good long time.

[Parameter setting]

Title	Function	Adjustment range	Default setting
F721	Selection of operation panel stop pattern	0: Deceleration stop 1: Coast stop	0

6.30 Tracing functions

F740 : Trace selection

F742 : Trace data 1

F741 : Trace cycle

F743 : Trace data 2

F744 : Trace data 3

F745 : Trace data 4

•Function

These parameters are used to memorize and read out the data collected at the time of tripping or triggering.

Up to 4 kinds of data can be selected from 64 kinds of data, and the data collected at 100 consecutive points can be stored in memory as trace data.

Here is the time at which trace data is acquired.

- Tripping: Data collected before the occurrence
- Triggering: Data collected after triggering

Note: To read data on a PC.

Title	Function	Adjustment range	Default setting
<i>F740</i>	Trace selection	0: Disabled 1: At tripping 2: At triggering 3: 1+2	1
<i>F741</i>	Trace cycle	0: 4ms 1: 20ms 2: 100ms 3: 1s 4: 10s	2
<i>F742</i>	Trace data 1	0-42	0
<i>F743</i>	Trace data 2	0-42	1
<i>F744</i>	Trace data 3	0-42	2
<i>F745</i>	Trace data 4	0-42	3

Note1: For saving trace data, do not disconnect power supply after inverter tripped.

Note2: When *F741*=0 or 1 setting, set the value of *F578* (Constant at the time of filtering) lower than *F741* setting time (trace cycle time).

- 1) To acquire trace data at the occurrence of tripping: $F740=1$
 (Examples of current date output)

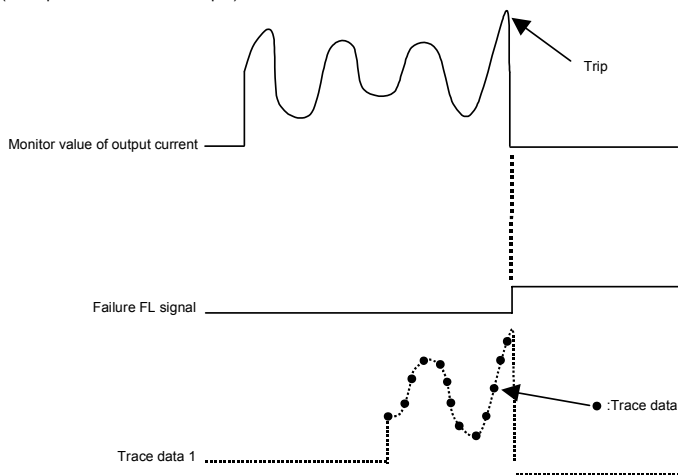

- 2) To acquire trace data at the time of triggering: $F740=2$

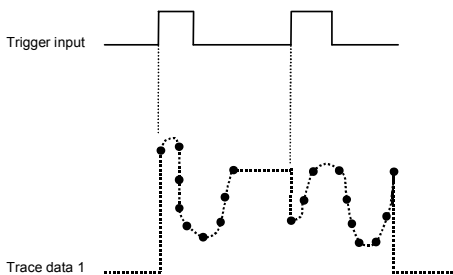

Ex.) When using the S3 terminal as the tracing back trigger signal terminal

Title	Function	Adjustment range	Example of setting
F 115	Input terminal function selection 6 (S3)	0-203	76: TRACE (Trace back trigger signal)

Setting value 77 is reverse signal.

Note 1: If the inverter trips when no trigger signal is given, trace data is overwritten with tripping data.

Note 2: Trace data is overwritten each time a trigger signal is given.

Note 3: When retry operation is occurred, the data at first tripping is written. The trace data is cleared at retry success.

(Setup values of F 742 to F 745)

Default setting	Communication No.	Trace (monitor) function	Communication unit at tracing
0	FD00	Operation frequency	0.01Hz
1	FD03	Output current	0.01%
2	FD02	Frequency setting value	0.01Hz
3	FD04	Input voltage (DC detection)	0.01%
4	FD05	Output voltage (command value)	0.01%
5	FD29	Input power	0.01kW
5	FD30	Output power	0.01kW
7	FD18	Torque	0.01%
9	FD23	Motor cumulative load factor	0.01%
10	FD24	Inverter cumulative load factor	0.01%
11	FD25	PBR (Braking resistor) cumulative load factor	0.01%
12	FD15	Frequency setting value (after compensation)	0.01Hz
13	FE35	VIA input value	0.01%
14	FE36	VIB input value	0.01%
18	FA51	Arbitrary code from communication	-
20	FE37	VIC input value	0.01%
21	FE56	Pulse train input value	1pps
23	FD22	PID feedback value	0.01Hz
24	FE76	Input power	1kWh
25	FE77	Output power	1kWh
26	FE26	Motor load factor	1%
27	FE27	Drive load factor	1%
40	FD06	Input terminal status	-
41	FD07	Output terminal status	-
42	FD01	Inverter status	-

■ Acquisition of trace data

Trace data is acquired through a communication device.

Trace data communication number

Communication No.	Function	Minimum setting /readout unit	Setting/readout range	Default setting
E000	Trace data 1~4 pointer	///	0~99	0
E100	Data 1 of trace data 1	///	0~FFFF	0
	Data 2~99 of trace data 1	///	0~FFFF	0
E199	Data 100 of trace data 1	///	0~FFFF	0
	Data 1 of trace data 2	///	0~FFFF	0
E200	Data 2~99 of trace data 2	///	0~FFFF	0
	Data 100 of trace data 2	///	0~FFFF	0
E299	Data 1 of trace data 3	///	0~FFFF	0
	Data 2~99 of trace data 3	///	0~FFFF	0
E399	Data 100 of trace data 3	///	0~FFFF	0
	Data 1 of trace data 4	///	0~FFFF	0
E400	Data 2~99 of trace data 4	///	0~FFFF	0
	Data 100 of trace data 4	///	0~FFFF	0
E499	Data 100 of trace data 4	///	0~FFFF	0

Ex.) When operation frequency data is acquired through a communication device

Data acquired (F 4 0) h=8000 \Rightarrow 8000 \times 0.01Hz=80.0Hz

Relationship between pointer and data

The table below shows the relationship between pointer (E000 set value) and trace data (1 to 4).

Pointer (E000 set value)	0	1	2	-	98	99
Trace data 1 (E100~E199)	E100	E101	E102	-	E198	E199
Trace data 2 (E200~E299)	E200	E201	E202	-	E298	E299
Trace data 3 (E300~E399)	E300	E301	E302	-	E398	E399
Trace data 4 (E400~E499)	E400	E401	E402	-	E498	E499

<Example of setting> If E000 is set to 2:

(Earliest data) (Latest data)

Trace data 1 E102 ~ E199, E100, E101

Trace data 2 E202 ~ E299, E200, E201

Trace data 3 E302 ~ E399, E300, E301

Trace data 4 E402 ~ E499, E400, E401

Note 1: Use the parameters F 7 4 2 through F 7 4 5 to specify the types of trace data (1 to 4).

Note 2: Communication numbers E000 is automatically incremented by the inverter when data is traced continuously.

* In ordinary cases, these parameters do not need to be rewritten.

6.31 Integrating wattmeter

F748 : Integrating wattmeter retention selection

F749 : Integrating wattmeter display unit selection

• **Function**

At the main power off, it is selectable whether retention of integral output power values or not. And also, the display unit is selectable.

The integrating wattmeter display can be cleared by external input signal by assignment of the terminal function. Input terminal function 74, 75 (Integrating wattmeter display clear)

Title	Function	Adjustment range	Default setting
<i>F748</i>	Integrating wattmeter retention selection	0: Disabled 1: Enabled	0
<i>F749</i>	Integrating wattmeter display unit selection	0:1=1kWh 1:1=10kWh 2:1=100kWh 3:1=1000kWh	Depends on the capacity (Refer to section 11.4)

6

6.32 Parameter registration to easy setting mode

F750 : EASY key function selection

F751 to **F782** : Easy setting mode parameter 1 to 32

Up to 32 arbitrary parameters can be registered to easy setting mode.

⇒ Refer to section 4.5 for details.

6.33 Communication function

6.33.1 Setting of communication function

F800	: Baud rate	F814	: Communication command point 2 frequency
F801	: Parity	F829	: Selection of communication protocol
F802	: Inverter number	F856	: Number of motor poles for communication
F803	: Communication time-out time	F870	: Block write data 1
F804	: Communication time-out action	F871	: Block write data 2
F805	: Communication waiting time	F875	: Block read data 1
F806	: Setting of master and slave for communication between inverters	F876	: Block read data 2
F808	: Communication time-out detection condition	F877	: Block read data 3
F810	: Communication command point selection	F878	: Block read data 4
F811	: Communication command point 1 setting	F879	: Block read data 5
F812	: Communication command point 1 frequency	F899	: Communication function reset
F813	: Communication command point 2 setting		



Warning



Mandatory
action

- Set the parameter Communication time-out time (**F803**) and Communication time-out action (**F804**). If these are not properly set, the inverter cannot be stopped immediately in breaking communication and this could result in injury and accidents.
- An emergency stop device and the interlock that fit with system specifications must be installed. If these are not properly installed, the inverter cannot be stopped immediately and this could result in injury and accidents.

Refer to the Communications Function Instruction Manual for details.

- Function

2-wire RS485 communication is built-in as standard.

Connect with the host to create a network for transmitting data between multiple inverters. A computer link function and Inverter-to-inverter communication function are available.

<Computer-linking functions>

The following functions are enabled by data communication between the computer and inverter

- (1) Monitoring inverter status (such as the output frequency, current, and voltage)
- (2) Sending RUN, STOP and other control commands to the inverter
- (3) Reading, editing and writing inverter parameter settings

< Inverter-to-inverter communication function >

This function allows you to set up a network that makes it possible to carry out proportional operation of multiple inverters (without using a computer).

- ★ Timer function ...Function used to detect cable interruptions during communication.
When data is not sent even once to the inverter during a user-defined period of time, an inverter trip (E r 5 is displayed on the panel) or an output terminal alarm("L" is displayed) can be output.
- ★ Broadcast communication function ...Function used to send a command (data write) to multiple inverters with a single communication.
- ★ Peer-to-peer communication function ...Refers to the function that enables the master inverter to send the data selected with a parameter to all slave inverters on the same network. This function allows you to set up a network that makes it possible to carry out synchronized operation or proportional operation (setting of point frequencies) in an abbreviated manner.
- ★ Communication protocol ...Toshiba inverter protocol and Modbus RTU protocol are supported.

★ 2-wire RS485 communication options are as follows.

- (1) USB communication conversion unit (Type: USB001Z)
Cable for communication between the inverter and the unit (Type: CAB0011 (1m), CAB0013 (3m), CAB0015 (5m))
Cable for communication between the unit and computer: Use a commercially available USB 1.1 or 2.0 cables. (Type: A-B, Cable length: 0.25 to 1.5m)
- (2) Parameter writer (Type: RKP002Z)
Communication cable (Type: CAB0011 (1m), CAB0013 (3m), CAB0015 (5m))
- (3) Remote keypad (Type: RKP007Z)
Communication cable (Type: CAB0071 (1m), CAB0073 (3m), CAB0075 (5m))

Note1) In case of using above options, set the parameter $F B 0 5 = 0.00$

■ Settings for run/stop via communication

Title	Function	Adjustment range	Standard defaults	Setting example
$\llcorner \text{P} \text{O} \text{d}$	Command mode selection	0 - 4	1 (Panel keypad)	2 (RS485 communications)

■ Settings for speed command via communication

Title	Function	Adjustment range	Standard defaults	Setting example
<i>F_{00d}</i>	Frequency setting mode selection	0 - 11	0 (Setting dial 1)	4 (RS485 communications)

■ Communication function parameters (2-wire RS485 communication)

Communication speed, parity, inverter number, and communication error trip time settings can be changed via panel operations or communication.

[Parameter setting]

Title	Function	Adjustment range	Default setting
<i>F₀₀₀</i>	Baud rate	3: 9600bps 4: 19200bps 5: 38400bps	4
<i>F₀₀₁</i>	Parity	0: NON (No parity) 1: EVEN (Even parity) 2: ODD (Odd parity)	1
<i>F₀₀₂</i>	Inverter number	0-247	0
<i>F₀₀₃</i>	Communication time-out time	0: Disabled (*) 0.1-100.0 (s)	0.0
<i>F₀₀₄</i>	Communication time-out action	0: Alarm only 1: Trip (Coast stop) 2: Trip (Deceleration stop)	0
<i>F₀₀₅</i>	Communication waiting time	0.00-2.00	0.00
<i>F₀₀₆</i>	Setting of master and slave for communication between inverters	0: Slave (0 Hz command issued in case the master inverter fails) 1: Slave (Operation continued in case the master inverter fails) 2: Slave (Emergency stop tripping in case the master inverter fails) 3: Master (transmission of frequency commands) 4: Master (transmission of output frequency signals)	0
<i>F₀₀₈</i>	Communication time-out detection condition	0: Valid at any time 1: Communication selection of <i>F_{00d}</i> or <i>C_{00d}</i> 2: 1 + during operation	1
<i>F₈₁₀</i>	Communication command point selection	0: Disabled 1: Enabled	0
<i>F₈₁₁</i>	Communication command point 1 setting	0-100	0
<i>F₈₁₂</i>	Communication command point 1 frequency	0.0- <i>F_H</i>	0
<i>F₈₁₃</i>	Communication command point 2 setting	0-100	100
<i>F₈₁₄</i>	Communication command point 2 frequency	0.0- <i>F_H</i>	*1
<i>F₈₂₉</i>	Selection of communication protocol	0: Toshiba inverter protocol 1: Modbus RTU protocol	0

Title	Function	Adjustment range	Default setting
<i>F856</i>	Number of motor poles for communication	1: 2 poles 2: 4 poles 3: 6 poles 4: 8 poles 5: 10 poles 6: 12 poles 7: 14 poles 8: 16 poles	2
<i>F870</i>	Block write data 1	0: No selection 1: Command information 1 2: Command information 2 3: Frequency setting 4: Output data on the terminal board	0
<i>F871</i>	Block write data 2	5: Analog output for communication 6: Speed command	0
<i>F875</i>	Block read data 1	0: No selection 1: Status information 2: Output frequency 3: Output current	0
<i>F876</i>	Block read data 2	4: Output voltage 5: Alarm information	0
<i>F877</i>	Block read data 3	6: PID feedback value 7: Input terminal board monitor 8: Output terminal board monitor	0
<i>F878</i>	Block read data 4	9: VIA terminal board monitor 10: VIB terminal board monitor 11: VIC terminal board monitor	0
<i>F879</i>	Block read data 5	12: Input voltage (DC detection) 13: Motor speed 14: Torque	0
<i>F899</i>	Communication function reset	0: - 1: Reset (after execution: 0)	0

*1: Default setting values vary depending on the setup menu setting. Refer to section 11.5.

★ Disabled.....Indicates that the inverter will not be tripped even if a communication error occurs.

Trip.....The inverter trips when a communication time-over occurs.

In this case a trip information *E r r 5* flashes on and off on the operation panel.

AlarmWhen a communication time-over occurs, an alarm can be output from the output terminal.

Output terminal function: 78 (RS485 communication error) or 79 (RS485 communication error reverse)

Note2) Changes to the parameters *F800*, *F801* and *F806* do not take effect until the power is turned off and then on again.

6.33.2 Using RS485

■ Communication function settings

Commands and frequency settings are given priority by communication. (Prioritized by commands from the panel or terminal block.) Thus, command and frequency settings from communication are activated, regardless of the command mode selection ($C \bar{N} \bar{D} \bar{d}$) or frequency settings mode selection settings ($F \bar{N} \bar{D} \bar{d}$). However, setting 48: SCLC (switching from communication to local) with input terminal function selection and when inputting from an external device, it is possible to operate at command mode selection ($C \bar{N} \bar{D} \bar{d}$) and frequency setting mode selection ($F \bar{N} \bar{D} \bar{d}$) settings.

Moreover, selecting local mode with the EASY key as Local / remote key function changes to panel frequency/panel operation mode.

■ Transmission specifications

Item	Specifications	
Communication protocol	TOSHIBA inverter protocol	MODBUS-RTU protocol
Interface	RS485 compliant	
Transmission scheme	Half duplex [bus type (Line terminations resistor necessary at both ends of system)]	
Wiring	2-wire	
Transmission distance	500 m max. (total length)	
Connection terminals	32max. (including upper host computer) Inverters connected in the system: 32max.	
Synchronization scheme	Start-stop synchronization	
Communication baud rate	9600 bps to 38.4kbps	
Character transmission	<ASCII mode> JIS X0201 8-bit(ASCII) <Binary mode> Binary codes fixed to 8 bits	Binary codes fixed to 8 bits
Error detecting scheme 1	Parity: Even/Odd/Non parity (selectable using a parameter)	
Error detecting scheme 2	Checksum	CRC
Stop bit length	Received by inverter : 1bit / Sent by inverter : 2 bits	
Order of bit transmission format	Low-order bits transmitted first	
Character transmission format	11-bit characters (Stop bit = 1 , with parity)	
Inverter Number	<ASCII mode> 0-99 <Binary mode> 0-63(3Fh)	1-247
Broadcast communication	Inverter Number should be set to <ASCII mode> ** (*? or ?? (?=0-9) is available) <Binary mode> 255 (0FFh)	Inverter Number should be set to 0
Frame length	Variable	
Error correction	None	
Response monitoring	None	
Other	Inverter operation at communication time-over: Select from trip/alarm/none → When alarm is selected, an alarm is output from the output terminal. When trip is selected, $E \bar{r} \bar{r} \bar{5}$ blinks on the panel.	

■ Connection example when using the computer link function

<Independent communication>

Perform computer-inverter connection as follows to send operation frequency commands from the host computer to inverter No. 3:

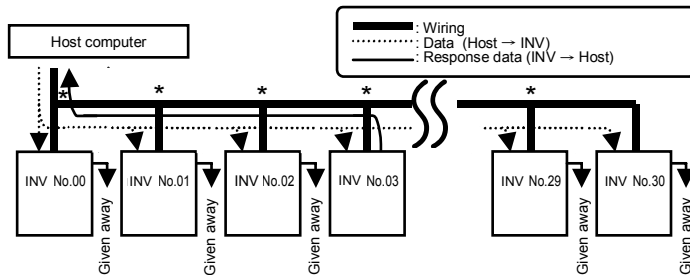

"Given away": Only the inverter with the selected inverter number conducts data processing. All other inverters, even if they have received the data, give it away and stand by to receive the next data.

* : Use the terminal board to branch the cable.

- (1) Data is sent from the host computer.
- (2) Data from the computer is received at each inverter and the inverter numbers are checked.
- (3) The command is decoded and processed only by the inverter with the selected inverter number.
- (4) The selected inverter responds by sending the processing results, together with its own inverter number, to the host computer.
- (5) As a result, only the selected inverter starts operating in accordance with the operation frequency command by communicating independently.

<Broadcast communication>

When sending an operation frequency command via a broadcast from the host computer

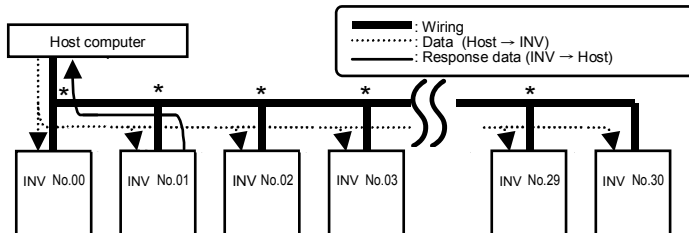

★ : Split the cable among terminal blocks.

- (1) Send data from the host computer.
- (2) The inverters receive data from the host computer and the inverter number is checked.
- (3) When * is next to the position of an inverter number, it is judged a broadcast. The command is decoded and processed.
- (4) To prevent data conflicts, only inverters where * is overwritten to 0 can reply with data to the host computer.
- (5) As a result, all inverters are operating with the broadcast operation frequency command.

Note: Specify inverter numbers by group for group broadcasts.

(Function only for ASCII mode. For parity mode, see the Communications Function Instruction Manual.)

(Ex) When *1 is set, inverters 01, 11, 21, 31 to 91 can be broadcast to.

In this case, the inverter specified in 01 can reply.

■ Peer-to-peer communication

When all slave inverters are connected they operate at the same frequency as the master inverter (no setting of point frequencies in this case)

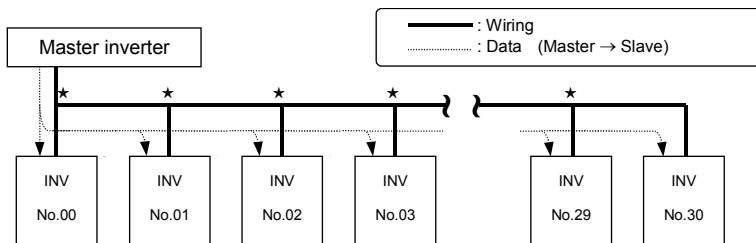

★: Use the terminal board to branch the cable.

- (1) The master inverter transmits frequency command data to its slave inverters.
- (2) The slave inverter calculate a frequency reference from the data received and save the frequency calculated.
- (3) As a result, all slave inverters operate at the same frequency as the master inverter.

Note: The master inverter always sends frequency command data to its slave inverters.

The slave inverters are always on standby so that they can receive an frequency command from the master inverter at anytime.

6.33.3 Free notes

F880: Free notes

- Function
To enable easier management and maintenance of the inverter, it is possible to enter the identification number.

[Parameter setting]

Title	Function	Adjustment range	Default setting
F880	Free notes	0 – 65530 (65535)	0

6.33.4 CANopen

E700 to **E799**: CANopen communication parameters

Refer to "CANopen communication Instruction Manual" for details.

6.33.5 Open network option

0000 to **1199** : Communication option common parameters

1500 to **1999** : ProfiBus DP option parameters

2000 to **2499** : DeviceNet option parameters

5000 to **5499** : EtherNet common parameters

5500 to **5999** : EtherNet IP option parameters

6000 to **6499** : Modbus TCP option parameters

★: ProfiBus DP option (Type: PDP003Z)

DeviceNet option (Type: DEV003Z)

EtherNet IP/Modbus TCP option (Type: IPE002Z)

Refer to each Instruction Manual for option for details.

6.34 Permanent magnet motors

F910 : Step-out detection current level

F911 : Step-out detection time

F912 : q-axis inductance

F913 : d-axis inductance

- Function

If the permanent magnet motor (PM motor) steps out and if the exciting current increases (it increases in such a case) and remains above the value set with **F910** for the period of time set with **F911**, the inverter will judge the motor to be stepping out and trip it. At that time, the trip message "SOUt" is displayed.

Title	Function	Adjustment range	Default setting
F910	Step-out detection current level	10 - 150 (%) / (A)	100
F911	Step-out detection time	0.00: No detection 0.01-2.55 (s)	0.00
F912	q-axis inductance	0.01-650.0 (mH)	10.00
F913	d-axis inductance	0.01-650.0 (mH)	10.00

⇒ Refer to section 6.21.2 about setting motor constants.

Note 1: When using an PM motor, consult your Toshiba dealer, since the inverter is not compatible with all types of PM motors.

Note 2: The inverter may fail to detect step-out in some cases, because it uses an electrical method to detect step-out. To avoid detection failures, you are recommended to install a mechanical step-out detector.

6.35 Traverse function

F980: Traverse selection

F981: Traverse acceleration time

F982: Traverse deceleration time

F983: Traverse step

F984: Traverse jump step

Refer to "Traverse function Instruction Manual" for details.

6.36 Logic sequence function

R900 to **R977** : Logic sequence function

Refer to "Logic sequence function Instruction Manual" for details.

7. Operations with external signal

7.1 Operating external signals

You can control the inverter externally.

The parameter settings differ depending upon your method of operation. Determine your method of operation (the operational signal input method, speed command input method) before using the procedure below to set the parameters.

[Procedure for setting parameters]

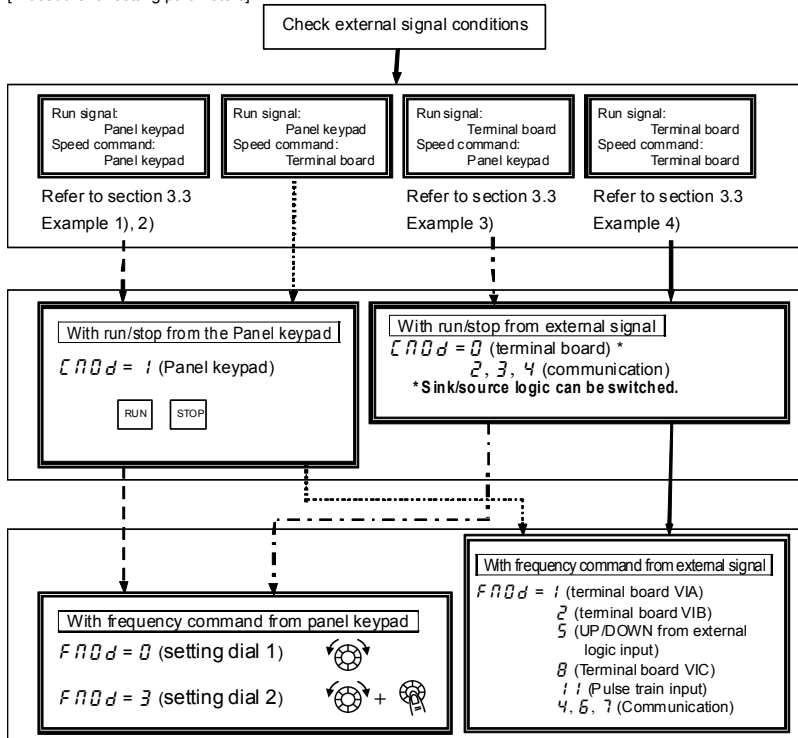

* For settings based on communication, refer to the Communication Instruction Manual or section 6.33.

7.2 Applied operations by an I/O signal (operation from the terminal block)

Input terminal sink and source logic are set by using slide switch SW1.

7.2.1 Input terminal function

This function is used to send a signal to the input terminal from an external programmable controller to operate or configure the inverter. The ability to select from a variety of functions allows for flexible system design.

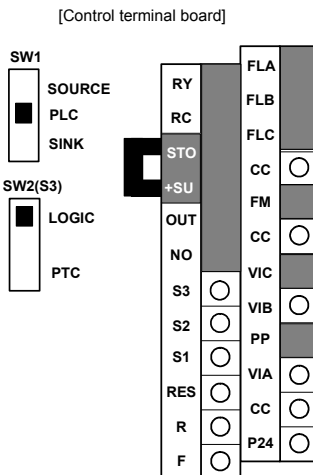

■ Settings for the logic input terminal function

Terminal symbol	Title	Function	Adjustment range	Default setting
F	F 111	Input terminal selection 1A (F)	0-203 Note 1)	2 (F)
	F 151	Input terminal selection 1B (F)		0 (No function)
	F 155	Input terminal selection 1C (F)		0 (No function)
R	F 112	Input terminal selection 2A (R)	0-203 Note 1)	4 (R)
	F 152	Input terminal selection 2B (R)		0 (No function)
	F 156	Input terminal selection 2C (R)		0 (No function)
RES	F 113	Input terminal selection 3A (RES)	0-203 Note 1)	8 (RES)
	F 153	Input terminal selection 3B (RES)		0 (No function)
S1	F 114	Input terminal selection 4A (S1)	0-203 Note 1)	10 (SS1)
	F 154	Input terminal selection 4B (S1)		0 (No function)
S2	F 115	Input terminal selection 5 (S2)	0-203 Note 3)	12 (SS2)
S3	F 116	Input terminal selection 6 (S3)	0-203 Note 4)	14 (SS3)
VIB	F 117	Input terminal selection 7 (VIB)	8-55 Note 5)	16 (SS4)
VIA	F 118	Input terminal selection 8 (VIA)	8-55 Note 6)	24 (AD2)
VIA VIB	F 109	Analog/logic input selection (VIA/VIB)	0-4	0
F to VIB	F 144	Input terminal response time	1-1000 (ms) Note 7)	1

- Note 1) Multiple functions assigned to a single terminal operate simultaneously.
- Note 2) In case of setting always active function, assign the menu number to $F 104$, $F 108$ and $F 110$ (always active function selection).
- Note 3) In case of using terminal S2 as a logic input, set the parameter $F 145=0$ (logic input).
- Note 4) In case of using terminal S3 as a logic input, set the slide switch SW2 to LOGIC side and the parameter $F 145=0$ (logic input).
- Note 5) In case of using terminal VIB as a logic input, set the parameter $F 109=1$ to 4 (logic input).
- Note 6) In case of using terminal VIA as a logic input, set the parameter $F 109=3$ or 4 (logic input).
- Note 7) When stable operation cannot be attained because of frequency setting circuit noise, increase $F 144$.

■ Connecting

- 1) For logic input

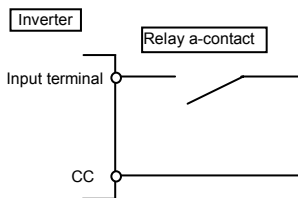

With sink settings

★ Operates by short circuiting between the input terminal and CC (common). Use for forward rotation, reverse rotation, and multi-stage speed.

- 2) For connection (sink logic) via transistor output

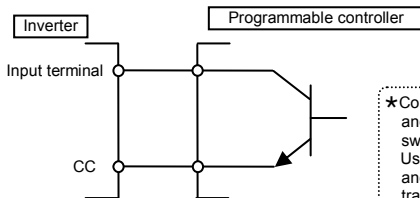

★ Control by connecting the input terminal and CC (common) to the output (non-logic switch) of the programmable controller. Use for forward rotation, reverse rotation, and multi-stage speed. Use a 5 mA transistor that operates at 24 V dc.

■ Usage example ... 3-wire operation (one-push operation)

Use the 3-wire operation function to operate the inverter, maintaining operation without using the sequence circuit by inputting an external signal (reset logic signal).

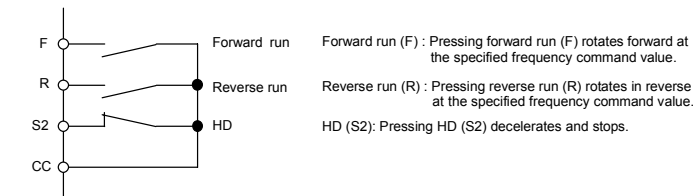

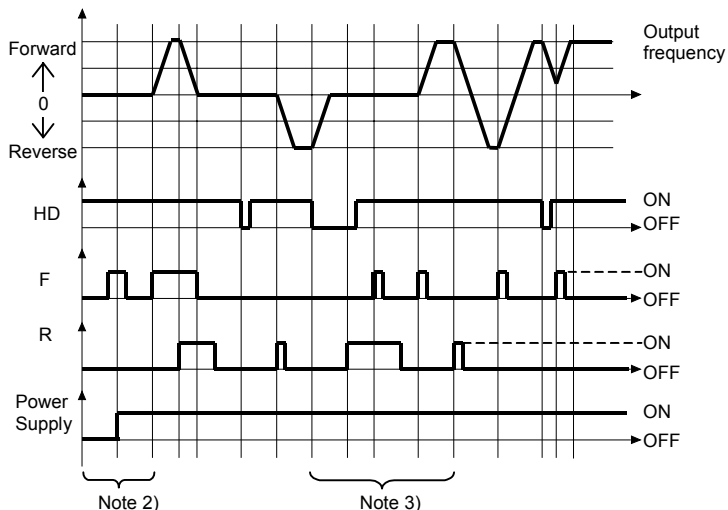

Note 1) Set $F110 = 5$ (ST: standby) and $C100d = 0$ (terminal board) for 3 wire operation. Assign HD (operation hold) to any input terminal at input terminal selection. When assigning the S2 terminal as shown above, set $F114 = 50$ (HD: operation hold).

Note 2) If the terminals are ON before turning on the power, terminal input is ignored when the power is turned ON. (Prevents sudden movements.) After turning the power ON, turn terminal input ON again.

Note 3) When HD is OFF, F and R are ignored even when ON. R does not operate even if it's ON when HD is ON. Likewise in this state, F does not operate even if it's ON. Turn F and R OFF and then turn them ON.

Note 4) During 3 wire operation, sending the jog run mode command stops operation.

Note 5) Be aware that DC braking continues even if a startup signal is input during DC braking.

Note 6) Only F and R maintain HD (operation hold). When using F or R in combination with other functions, be aware that the other functions do not hold. For example, when F and SS1 are assigned, F holds, but SS1 does not.

[Parameter settings]

Terminal symbol	Title	Function	Adjustment range	Setting example
S2	F115	Input terminal selection 5 (S2)	0-203	50: HD (Operation hold)

■ List of logic input terminal function settings

Parameter programmed value		Function	Parameter programmed value		Function
Positive logic	Negative logic		Positive logic	Negative logic	
0	1	No function	70	71	Factory specific coefficient *1
2	3	Forward run command	74	75	Integrating wattmeter (kWh) display clear
4	5	Reverse run command	76	77	Trace back trigger signal
6	7	Standby	78	79	Light-load high-speed operation prohibitive signal
8	9	Reset command	80	81	Holding of RY-RC terminal output
10	11	Preset-speed command 1	82	83	Holding of OUT-NO terminal output
12	13	Preset-speed command 2	88	89	Frequency UP *2
14	15	Preset-speed command 3	90	91	Frequency DOWN *2
16	17	Preset-speed command 4	92	93	Clear frequency UP/DOWN *2
18	19	Jog run mode	96	97	Coast stop command
20	21	Emergency stop by external signal	98	99	Forward/reverse selection
22	23	DC braking command	100	101	Run/Stop command
24	25	2nd acceleration/deceleration	104	105	Frequency reference command forced switching
26	27	3rd acceleration/deceleration	106	107	Frequency setting mode terminal board
28	29	2nd V/F control mode switching	108	109	Command mode terminal board
32	33	2nd stall prevention level	110	111	Parameter editing permission
36	37	PID control prohibition	120	121	Fast stop command 1
46	47	External thermal error input	122	123	Fast stop command 2
48	49	Forced local from communication	134	135	Traverse permission signal
50	51	Operation hold (hold of 3-wire operation)	136	137	Factory specific coefficient *1
52	53	PID integral/differential clear	140	141	Forward deceleration
54	55	PID characteristics switching	142	143	Forward stop
56	57	Forced run operation	144	145	Reverse deceleration
58	59	Fire speed operation	146	147	Reverse stop
60	61	Acceleration/deceleration suspend signal	148 to 151		Factory specific coefficient *1
62	63	Power failure synchronized signal	200	201	Parameter editing prohibition
64	65	Logic sequence function trigger signal	202	203	Parameter editing prohibition

*1: Factory specific coefficients are manufacturer setting menus. Do not change the value of these parameters.

*2: Active when $FNDd$ (frequency setting mode selection) = 5 (UP/DOWN from external logic input) is set.

The frequency setup range is from 0.0 to UL (upper limit frequency). The acceleration/deceleration time relative to the set frequency is ACC/DEC while the acceleration/deceleration speed is not switched.

☆ Refer to section 11.6 for details about the input terminal function.

7.2.2 Output terminal function (sink logic)

This function is used to output a variety of signals to external devices from the inverter. With the logic output terminal function, you can select from multiple output terminal functions. Set two types of functions for the RY-RC, OUT terminal and then you can output when either one or both of them is ON.

[Control terminal block]

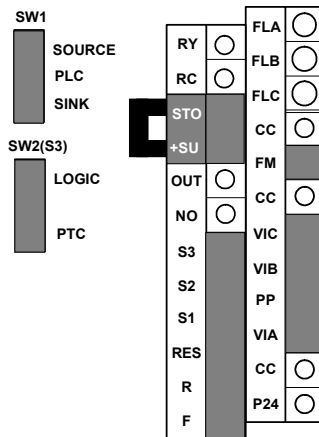

■ Usage

FLA, B, C function: Set at parameter *F 132*.
Note 1)

RY function: Set at parer *F 130* and *137*.
Note 1)

OUT function: Set at parameter *F 131* and *138*.

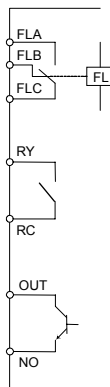

Note1) A chattering (momentary ON/OFF of contact) is generated by external factors of the vibration and the impact, etc. In particular, please set the filter of 10ms or more, or timer for measures when connecting it directly with input unit terminal of programmable controller. Please use the OUT terminal as much as possible when the programmable controller is connected.

■ Assign one type of function to an output terminal

Terminal symbol	Title	Function	Adjustment range	Default setting
RY-RC	<i>F 130</i>	Output terminal selection 1A	0 - 255	4 (Low-speed detection signal)
OUT	<i>F 131</i>	Output terminal selection 2A		6 (Output frequency attainment signal)
FL (A, B, C)	<i>F 132</i>	Output terminal selection 3		10 (Fault signal)

Note 2) When assigning 1 type of function to the RY-RC terminal, set only *F 130*.

Leave parameter *F 137* as the standard setting (*F 137 = 255*).

Note 3) When assigning 1 type of function to the OUT terminal, set only *F 131*.

Leave parameter *F 138* as the standard setting (*F 138 = 255*).

■ Assign two types of functions to the output terminal (RY-RC, OUT)

Terminal symbol	Title	Function	Adjustment range	Default setting
RY-RC	<i>F 130</i>	Output terminal selection 1A	0 - 255	4 (Low-speed detection signal)
OUT	<i>F 131</i>	Output terminal selection 2A		6 (Output frequency attainment signal)
RY-RC	<i>F 137</i>	Output terminal selection 1B		255 (Always ON)
OUT	<i>F 138</i>	Output terminal selection 2B		
RY-RC, OUT	<i>F 139</i>	Output terminal logic selection	0: <i>F 130</i> and <i>F 137</i> <i>F 131</i> and <i>F 138</i> 1: <i>F 130</i> or <i>F 137</i> <i>F 131</i> and <i>F 138</i> 2: <i>F 130</i> and <i>F 137</i> <i>F 131</i> or <i>F 138</i> 3: <i>F 130</i> or <i>F 137</i> <i>F 131</i> or <i>F 138</i>	0

Note 4) *F 131* and *F 138* are active only when *F 669 = 0*: Logic output (default).

Function is inactive when *F 669 = 1*: Pulse train output is set.

(1) Output signals when two types of functions are simultaneously turned ON.

Signals are output when parameter $F 139 = 0$ or 2 , and the functions set at parameters $F 130$ and $F 137$ are simultaneously turned ON.

☆ Timing chart

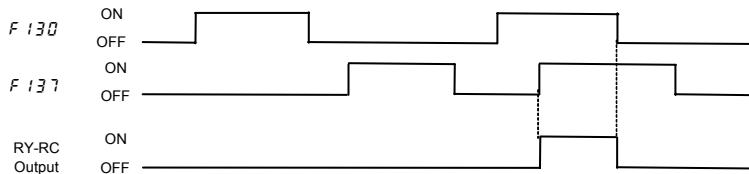

(2) Output signals when either one of two types of functions are simultaneously turned ON.

Signals are output when parameter $F 139 = 1$ or 3 , and either of the functions set at parameters $F 130$ and $F 137$ are turned on.

☆ Timing chart

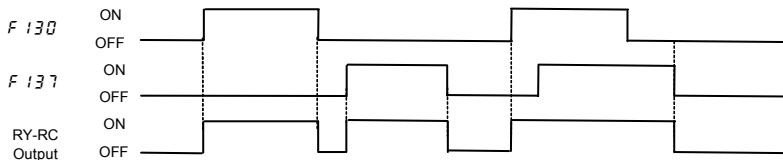

- (3) The logical product (AND) or logical sum (OR) of the two functions assigned is put out as a signal.

■ Setting of output terminal function

Terminal symbol	Title	Function	Adjustment range	Default setting
RY-RC	<i>F 130</i>	Output terminal selection 1A	0-255	4 (LOW)
OUT	<i>F 131</i>	Output terminal selection 2A		6 (RCH)
FL	<i>F 132</i>	Output terminal selection 3		10 (FL)
RY-RC	<i>F 137</i>	Output terminal selection 1B		255 (always ON)
OUT	<i>F 138</i>	Output terminal selection 2B		255 (always ON)
RY-RC/ OUT	<i>F 139</i>	Output terminal logic selection	0: <i>F 130</i> and <i>F 137</i> <i>F 131</i> and <i>F 138</i> 1: <i>F 130</i> or <i>F 137</i> <i>F 131</i> and <i>F 138</i> 2: <i>F 130</i> and <i>F 137</i> <i>F 131</i> or <i>F 138</i> 3: <i>F 130</i> or <i>F 137</i> <i>F 131</i> or <i>F 138</i>	0

Two different functions can be assigned to the output terminals (RY-RC and OUT-NO), and two logics with different functions can be selected using *F 139*.

The logical product (AND) or logical sum (OR) of the two functions assigned is put out as a signal, depending on the setting of parameter *F 139*.

If *F 139* = 0, the logical sum (AND) of *F 130* and *F 137* will be output to RY-RC.

The logical product (OR) of *F 131* and *F 138* will be output to OUT-NO.

If *F 139* = 1, the logical product (OR) of *F 130* and *F 137* will be output to RY-RC.

The logical sum (AND) of *F 131* and *F 138* will be output to OUT-NO.

If *F 139* = 2, the logical sum (AND) of *F 130* and *F 137* will be output to RY-RC.

The logical product (OR) of *F 131* and *F 138* will be output to OUT-NO.

If *F 139* = 3, the logical product (OR) of *F 130* and *F 137* will be output to RY-RC.

The logical product (OR) of *F 131* and *F 138* will be output to OUT-NO.

- ★ To assign only one function to output terminals, assign the function to *F 130* and *F 131* while leaving *F 137* to *F 139* as they are set by default.

Note: *F 138* (OUT-NO): Enable only when *F 669*=0

Disabled and the set value cannot be read out, if *F 669* is set to 1.

(4) Holding the output of signals in ON status

- ★ If the conditions for activating the functions assigned to output terminals RY-RC and OUT-NO agree with and as a result the output of signals is put in ON status, the output of signals is held ON, even if the conditions change. (Output terminal holding function)
- ★ Assign input terminal function 80 to 83 to a logic input terminal available.

■ Input terminal function

Function No.	Code	Function	Action
80	HDRY	Holding of RY-RC terminal output	ON: Once turned on, RY-RC are held on. OFF: The status of RY-RC changes in real time according to conditions.
82	HDOU	Holding of OUT-NO terminal output	ON: Once turned on, OUT-NO are held on. OFF: The status of OUT-NO changes in real time according to conditions.

Each of the following numbers (81, 83) are reverse signals.

- ★ Once output terminal RY-RC or OUT-NO is turned on when the contact input terminal to which one of the above functions (function 80 to 83) is assigned is ON, output terminal RY-RC or OUT-NO is held ON.

■ List of output terminal function settings

<Explanation of terminology>

- Alarm Alarm output when a setting has been exceeded.
- Pre-alarm Alarm output when the inverter may cause a trip during continued operation.

List of detection levels for output terminal selection

Parameter programmed value		Function	Parameter programmed value		Function
Positive logic	Negative logic		Positive logic	Negative logic	
0	1	Frequency lower limit	106	107	Light load output
2	3	Frequency upper limit	108	109	Heavy load output
4	5	Low-speed detection signal	120	121	Lower limit frequency stop
6	7	Output frequency attainment signal (acceleration/deceleration completed)	122	123	Power failure synchronized operation
8	9	Set frequency attainment signal	124	125	Traverse in progress
10	11	Fault signal (trip output)	126	127	Traverse deceleration in progress
14	15	Over-current pre-alarm	128	129	Parts replacement alarm
16	17	Overload pre-alarm	130	131	Over-torque detection pre-alarm
20	21	Overheat pre-alarm	132	133	Frequency setting mode selection 1/2
22	23	Overvoltage pre-alarm	136	137	Panel / remote selection
24	25	Power circuit undervoltage detection	138	139	Forced continuous operation in progress
26	27	Small current detection	140	141	Specified frequency operation in progress
28	29	Over-torque detection	144	145	Signal in accordance of frequency command
30	31	Braking resistor overload pre-alarm	146	147	Fault signal (output also at a retry waiting)
40	41	Run/Stop	150	151	PTC input alarm signal
42	43	Heavy fault	152	153	Safe torque off signal
44	45	Light fault	154	155	Analog input break detection alarm
50	51	Cooling fan ON/OFF	156	157	F terminal state
52	53	In jogging operation	158	159	R terminal status
54	55	Operation panel / terminal board operation	160	161	Cooling fan replacement alarm
56	57	Cumulative operation time alarm	162	163	Number of starting alarm
58	59	Communication option communication error	166	167	Acceleration operation in progress
60	61	Forward/reverse run	168	169	Deceleration operation in progress
62	63	Ready for operation 1	170	171	Constant speed operation in progress
64	65	Ready for operation 2	172	173	DC braking in progress
68	69	Brake release	174 to 179		Factory specific coefficient *1
70	71	Pre-alarm	222 to 253		Logic sequence function output 1 to 16
78	79	RS485 communication error	254		Always OFF
92	93	Designated data output 1	255		Always ON
94	95	Designated data output 2			

*1: Factory specific coefficients are manufacturer setting menus. Do not change the value of these parameters.

Note 1) ON with positive logic : Open collector output transistor or relay turned ON.
OFF with positive logic : Open collector output transistor or relay turned OFF.
ON with negative logic : Open collector output transistor or relay turned OFF.
OFF with negative logic: Open collector output transistor or relay turned ON.

☆ Refer to section 11.7 for details about the output terminal functions or levels.

7.3 Speed instruction (analog signal) settings from external devices

Function of analog input terminals can be selected from four functions (external potentiometer, 0 to 10Vdc, 4 (0) to 20mA dc, -10 to +10Vdc).

The selective function of analog input terminals gives system design flexibility.

The maximum resolution is 1/1000.

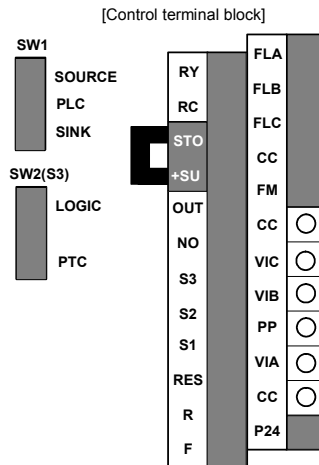

■ Analog input terminal function settings

Terminal symbol	Title	Function	Adjustment range	Default setting
-	<i>F200</i>	Frequency priority selection	0, 1	0
VIA	<i>F201</i>	VIA input point 1 setting	0 - 100%	0
	<i>F202</i>	VIA input point 1 frequency	0.0 - 500.0Hz	0.0
	<i>F203</i>	VIA input point 2 setting	0 - 100%	100
	<i>F204</i>	VIA input point 2 frequency	0.0 - 500.0Hz	*1
-	<i>F207</i>	Frequency setting mode selection 2	0-11	1
VIA to VIC	<i>F209</i>	Analog input filter	4 - 1000 ms Note 1)	64
VIB	<i>F210</i>	VIB input point 1 setting	0 - 100%	0
	<i>F211</i>	VIB input point 1 frequency	0.0 - 500.0Hz	0.0
	<i>F212</i>	VIB input point 2 setting	0 - 100%	100
	<i>F213</i>	VIB input point 2 frequency	0.0 - 500.0Hz	*1
VIC	<i>F216</i>	VIC input point 1 setting	0 - 100%	0
	<i>F217</i>	VIC input point 1 frequency	0.0 - 500.0Hz	0.0
	<i>F218</i>	VIC input point 2 setting	0 - 100%	100
	<i>F219</i>	VIC input point 2 frequency	0.0 - 500.0Hz	*1

*1: Default setting values vary depending on the setup menu setting. Refer to section 11.5.

Note1) When stable operation cannot be attained because of frequency setting circuit noise, increase *F209*.

7.3.1 Settings depending on voltage (0 to 10 V) input

You can set the frequency settings by inputting an analog voltage signal of 0 to 10Vdc between the VIA and CC terminals.

The following shows examples when the run command is input from the terminal.

Title	Function	Adjustment range	Default setting	Setting example
<i>CMod</i>	Command mode selection	0 - 4	1 (panel keypad)	0 (terminal board)
<i>FMod</i>	Frequency setting mode selection	0 - 11	0 (setting dial 1)	1 (terminal board VIA)
<i>F109</i>	Analog/logic input selection (VIA/VIB)	0 - 4	0	0 - 2 (Voltage signal (0 - 10V))
<i>F201</i>	VIA input point 1 setting	0 - 100%	0	0
<i>F202</i>	VIA input point 1 frequency	0.0 - 500.0Hz	0.0	0.0
<i>F203</i>	VIA input point 2 setting	0 - 100%	100	100
<i>F204</i>	VIA input point 2 frequency	0.0 - 500.0Hz	*1	50.0/60.0
<i>F209</i>	Analog input filter	2 - 1000 ms	64	64

*1: Default setting values vary depending on the setup menu setting. Refer to section 11.5.

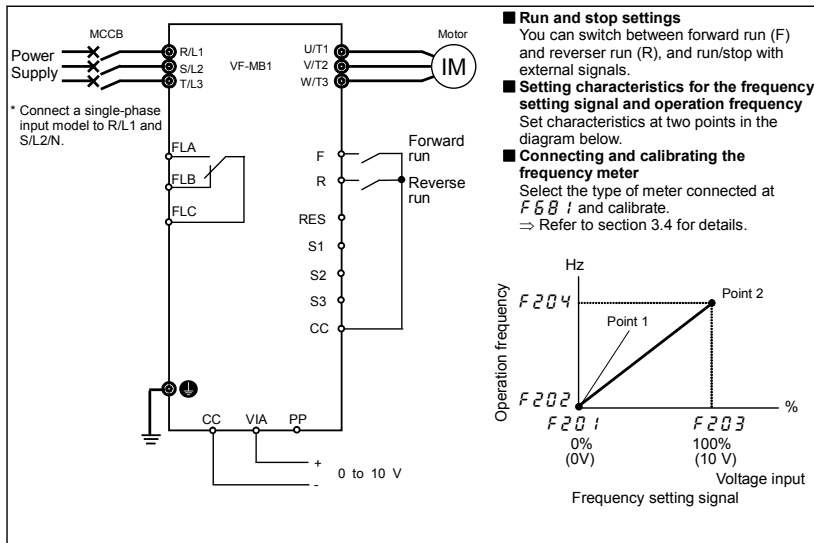

7.3.2 Settings depending on current (4 to 20 mA) input

You can set the frequency settings by inputting an analog current signal of 4 (0) to 20mA dc between the VIC and CC terminals.

The following shows examples when the run command is input from the terminal.

Title	Function	Adjustment range	Default setting	Setting example
<i>F00d</i>	Command mode selection	0 – 4	1 (panel keypad)	0 (terminal board)
<i>F00d</i>	Frequency setting mode selection	0 – 11	0 (setting dial 1)	8 (terminal board VIC)
<i>F216</i>	VIC input point 1 setting	0 – 100%	0	20 (or 0)
<i>F217</i>	VIC input point 1 frequency	0.0 - 500.0Hz	0.0	0.0
<i>F218</i>	VIC input point 2 setting	0 – 100%	100	100
<i>F219</i>	VIC input point 2 frequency	0.0 - 500.0Hz	*1	50.0/60.0
<i>F209</i>	Analog input filter	2 - 1000 ms	64	64

*1: Default setting values vary depending on the setup menu setting. Refer to section 11.5.

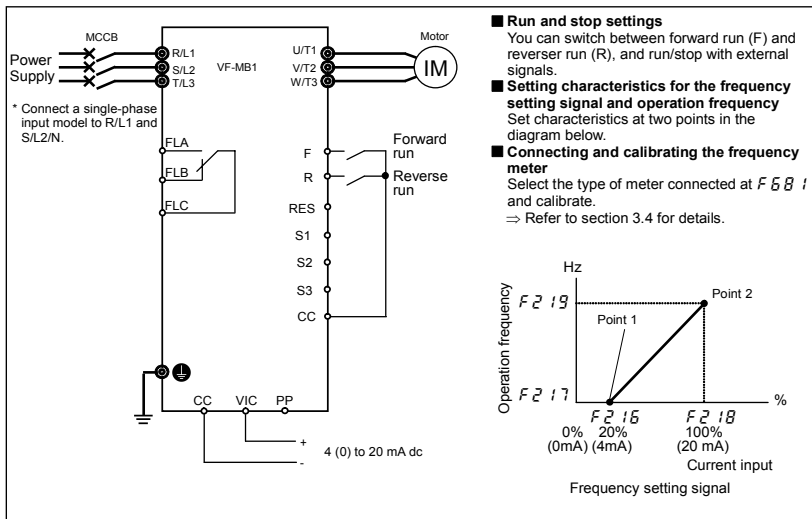

7.3.3 Settings depending on voltage (-10 to +10 V) input

You can set the frequency settings by inputting an analog voltage signal of -10 to +10Vdc between the VIB and CC terminals.

The following shows examples when the run command is input from the terminal.

Title	Function	Adjustment range	Default setting	Setting example
<i>C N 0 d</i>	Command mode selection	0 - 4	1 (panel keypad)	0 (terminal board)
<i>F N 0 d</i>	Frequency setting mode selection	0 - 11	0 (setting dial 1)	2 (terminal board VIB)
<i>F 1 0 7</i>	Analog input terminal selection (VIB)	0: 0-+10V 1: -10-+10V	0	1 (-10 - +10V)
<i>F 1 0 9</i>	Analog/logic input selection (VIA/VIB)	0 - 4	0	0 (Analog input)
<i>F 2 1 0</i>	VIB input point 1 setting	0 - 100%	0	0
<i>F 2 1 1</i>	VIB input point 1 frequency	0.0 - 500.0Hz	0.0	0.0
<i>F 2 1 2</i>	VIB input point 2 setting	0 - 100%	100	100
<i>F 2 1 3</i>	VIB input point 2 frequency	0.0 - 500.0Hz	*1	50.0/60.0
<i>F 2 0 9</i>	Analog input filter	2 - 1000 ms	64	64

*1: Default setting values vary depending on the setup menu setting. Refer to section 11.5.

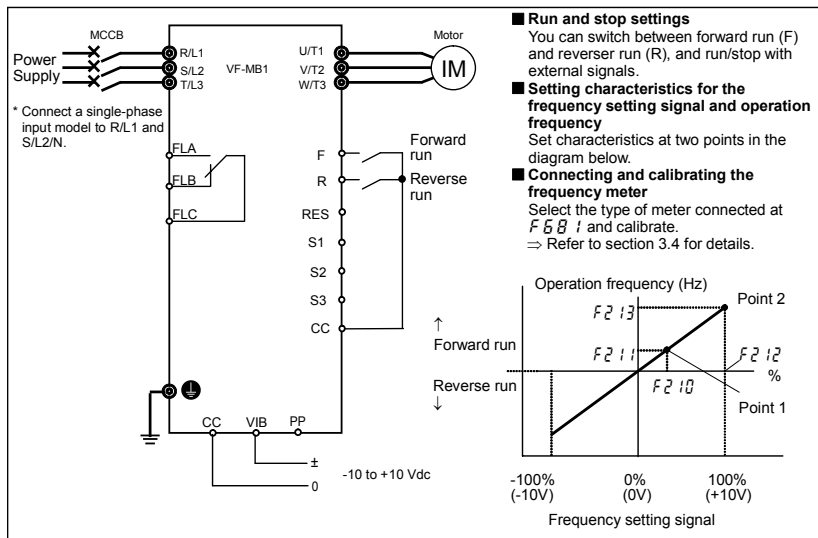

8. Monitoring the operation status

8.1 Flow of status monitor mode

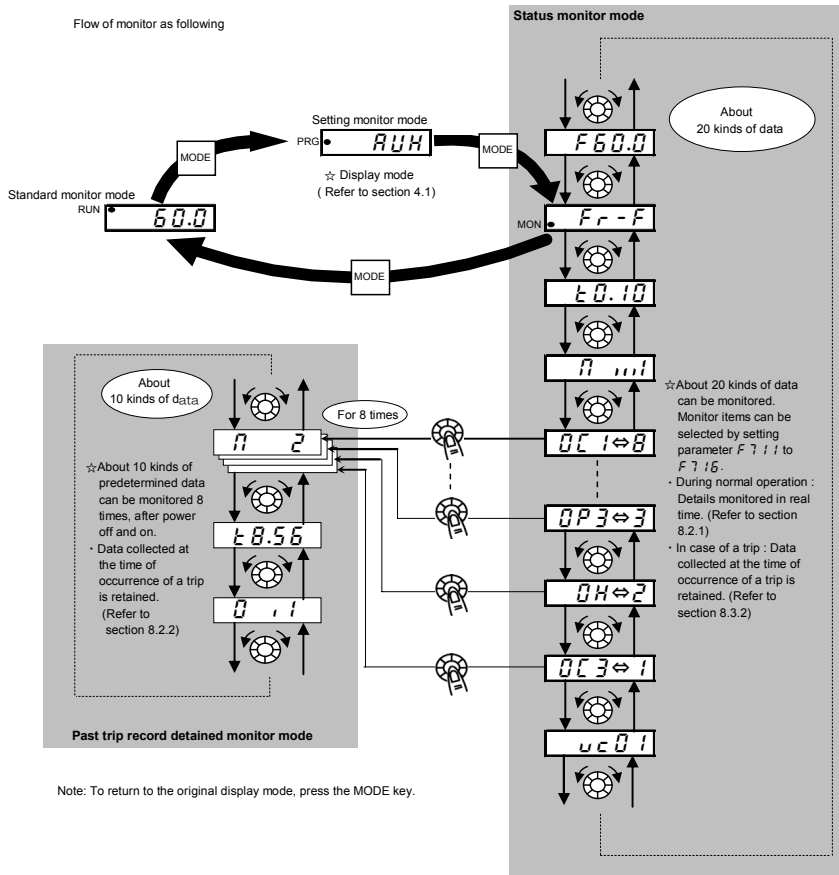

8.2 Status monitor mode









8.2.1 Status monitor under normal conditions

In this mode, you can monitor the operation status of the inverter.

To display the operation status during normal operation:

Press the MODE key twice.

Setting procedure (eg. operation at 60Hz)

	Item displayed	Panel operated	LED display	Communication No.	Description
	Operation frequency *		60.0		The operation frequency is displayed (Operation at 60Hz). (When standard monitor display selection $F710$ is set at 0 [operation frequency])
	Parameter setting mode	MODE	RUH		The first basic parameter "RUH" (history function) is displayed.
	Direction of rotation	MODE	F _r -F	FE01	The direction of rotation is displayed. (F _r -F: forward run, F _r -r: reverse run)
Note 1	Frequency setting value *		F60.0	FE02	The operation frequency command value (Hz/free unit) is displayed. (In case of $F711=2$)
Note 2	Output current *		180	FC02	The inverter output current (load current) (%A) is displayed. (In case of $F712=1$)
Note 3	Input voltage *		4100	FC05	The inverter input (DC) voltage (%V) is displayed. (In case of $F713=3$)
	Output voltage *		P100	FC08	The inverter output voltage (%V) is displayed. (In case of $F714=4$)
	Input power *		h12.3	FC06	The inverter input power (kW) is displayed. (In case of $F715=5$)
	Output power *		H11.8	FC07	The inverter output power (kW) is displayed. (In case of $F716=6$)
	Inverter load factor *		L70	FE27	The inverter load factor (%) is displayed. (In case of $F717=7$)
Note 1	Operation frequency *		060.0	FE00	The operation frequency (Hz/free unit) is displayed. (In case of $F718=0$)

* Monitor items can be selected by setting parameters $F710$ to $F718$. ($F720$). Note 12

Refer to page H-8 for notes.

(Continued overleaf)

(Continued)

	Item displayed	Panel operated	LED display	Communication No.	Description
Note 4	Input terminal		FE06	The ON/OFF status of each of the control signal input terminals (F, R, RES, S1, S2, S3, VIB, VIA) are displayed in bits. ON: OFF:
Note 5	Output terminal		0 . . .	FE07	The ON/OFF status of each of the control signal output terminals (RY-RC, OUT, FL) are displayed in bits. ON: OFF:
	CPU1 version		v 1 0 1	FE08	The version of the CPU1 is displayed.
	CPU2 version		v c 0 1	FE73	The version of the CPU2 is displayed.
	Inverter rated current		A 33.0	FE70	The inverter rated current (A) is displayed.
Note 6	Overload and region setting		C - EU	0998 0099	The inverter overload characteristic and region setting is displayed.
Note 7	Past trip 1		0 P 2 ⇔ 1	FE10	Past trip 1 (displayed alternately)
Note 7	Past trip 2		0 H ⇔ 2	FE11	Past trip 2 (displayed alternately)
Note 7	Past trip 3		0 P 3 ⇔ 3	FE12	Past trip 3 (displayed alternately)
Note 7	Past trip 4		0 L 1 ⇔ 4	FE13	Past trip 4 (displayed alternately)
Note 7	Past trip 5		0 L r ⇔ 5	FD10	Past trip 5 (displayed alternately)
Note 7	Past trip 6		0 C 1 ⇔ 6	FD11	Past trip 6 (displayed alternately)
Note 7	Past trip 7		0 C 2 ⇔ 7	FD12	Past trip 7 (displayed alternately)
Note 7	Past trip 8		n E r r ⇔ 8	FD13	Past trip 8 (displayed alternately)

Refer to page H-8 for notes.

(Continued overleaf)

(Continued)

	Item displayed	Panel operated	LED display	Communication No.	Description
Note 8	Parts replacement alarm information		$n \dots \dots$	FE79	The ON/OFF status of each of the cooling fan, circuit board capacitor, main circuit capacitor of parts replacement alarm, cumulative operation time or number of starting are displayed in bits. ON: OFF: Number of starting ———— Cumulative operation time ———— Main circuit capacitor ———— Cooling fan ———— Control circuit board capacitor ————
	Number of starting		$n 34.5$	FD32	Number of starting (10000 times)
Note 9	Cumulative operation time		$t 0.10$	FE14	The cumulative operation time is displayed. (0.1=10 hours, 1.00=100 hours)
	Default display mode		60.0		The operation frequency is displayed (Operation at 60Hz).

8.2.2 Display of detailed information on a past trip

Details on a past trip (of trips 1 to 8) can be displayed, as shown in the table below, by pressing the center of the setting dial when the trip record is selected in the status monitor mode.

Unlike the "Display of trip information at the occurrence of a trip" in 8.3.2, details on a past trip can be displayed, even after the inverter is turned off or reset.

	Item displayed	Panel operated	LED display	Description
Note 10	Past trip 1		$0 \llcorner 1 \supset 1$	Past trip 1 (displayed alternately)
	Continuous trips		$n 2$	For $0 \llcorner 8$, $0 \llcorner 1$ and $E r r 5$ the number of times (maximum of 31) the same trip occurred in succession is displayed (unit: times). Detailed information is recorded at the beginning and ending numbers.
Note 1	Operation frequency		$o 60.0$	The operation frequency when the trip occurred is displayed.
	Direction of rotation		$F r - F$	The direction of rotation when the trip occurred is displayed. ($F r - F$: Forward run, $F r - r$: Reverse run)
	Frequency setting value *		$F 80.0$	The operation command value when the trip occurred is displayed.
Note 2	Output current		$\llcorner 150$	The inverter output current when the trip occurred is displayed. (%/A)

Refer to page H-8 for notes.

(Continued overleaf)

(Continued)

	Item displayed	Panel operated	LED display	Description
Note 3	Input voltage		4 120	The inverter input voltage (DC) when the trip occurred is displayed. (%N).
	Output voltage		P 100	The inverter output voltage when the trip occurred is displayed. (%N)
Note 4	Input terminal		The ON/OFF status of each of the control signal input terminals (F, R, RES, S1, S2, S3, VIB, VIA) are displayed in bits. ON: OFF: .
Note 5	Output terminal		0 . . .	The ON/OFF status of each of the control signal output terminals (RY-RC, OUT, FL) are displayed in bits. ON: OFF: .
Note 8	Cumulative operation time		t 8.56	The cumulative operation time when the trip occurred is displayed. (0.1=10 hours, 1.00=100 hours)
	Past trip 1		001 ⇄ 1	Press this key to return to past trip 1.

* The monitor value of a trip is not always recorded as the maximum value because of the time required for detection.

Refer to page H-8 for notes.

8.3 Display of trip information

8.3.1 Trip code display

If the inverter trips, an error code is displayed to suggest the cause. Since trip records are retained, information on each trip can be displayed anytime in the status monitor mode.

Refer to section 13.1 for details about trip code display.

☆ The monitor value of a trip is not always recorded as the maximum value because of the time required for detection.

8.3.2 Display of trip information at the occurrence of a trip

At the occurrence of a trip, the same information as that displayed in the mode described in " 8.2.1 Status monitor under normal conditions ", can be displayed, as shown in the table below, if the inverter is not turned off or reset.

To display trip information after turning off or resetting the inverter, follow the steps described in " 8.2.2 Display of detailed information on a past trip ".

■ Example of call-up of trip information















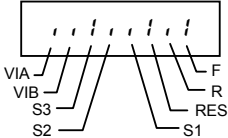



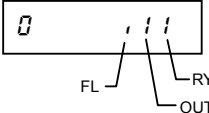













Item displayed	Panel operated	LED display	Communication No.	Description
Cause of trip		OPZ		Status monitor mode (The code blinks if a trip occurs.) The motor coasts and comes to a stop (coast stop).
Parameter setting mode	MODE	RUH		The first basic parameter "RUH" (history function) is displayed.
Direction of rotation	MODE	F _r -F	FE01	The direction of rotation at the occurrence of a trip is displayed. (F _r - F : forward run, F _r - r : reverser run).
Note 1 Frequency setting value *		F60.0	FE02	The operation frequency command value (Hz/free unit) at the occurrence of a trip is displayed. (In case of F711=2)
Note 2 Output current *		I130	FC02	The output power of the inverter at the occurrence of a trip (%A) is displayed. (In case of F712=1)
Note 3 Input voltage *		V141	FC05	The inverter input (DC) voltage (%V) at the occurrence of a trip is displayed. (In case of F713=3)
Output voltage *		P100	FC08	The output voltage of the inverter at the occurrence of a trip (%V) is displayed. (In case of F714=4)
Input power *		h12.3	FC06	The inverter input power (kW) is displayed. (In case of F715=5)
Output power *		H11.8	FC07	The inverter output power (kW) is displayed. (In case of F716=6)
Inverter load factor *		L70	FE27	The inverter load factor (%) at the occurrence of a trip is displayed. (In case of F717=27)
Note 1 Operation frequency *		o60.0	FE00	The inverter output frequency (Hz/free unit) at the occurrence of a trip is displayed. (In case of F718=0)

* Monitor items can be selected by settings parameters F710 to F718 (F720). Note 12

Refer to page H-8 for notes.

(Continued overleaf)





(Continued)

	Item displayed	Panel operated	LED display	Communication No.	Description
Note 4	Input terminal			FE06	<p>The ON/OFF status of each of the control signal input terminals (F, R, RES, S1, S2, S3, VIB, VIA) are displayed in bits.</p> <p>ON:  / OFF: </p> 
Note 5	Output terminal			FE07	<p>The ON/OFF status of each of the control signal output terminals (RY-RC, OUT, FL) are displayed in bits.</p> <p>ON:  / OFF: </p> 
	CPU1 version			FE08	The version of the CPU1 is displayed.
	CPU2 version			FE73	The version of the CPU2 is displayed.
	Inverter rated current			FE70	The inverter rated current (A) is displayed.
Note 6	Overload and region setting			0998 0099	The inverter overload characteristic and region setting is displayed.
Note 7	Past trip 1			FE10	Past trip 1 (displayed alternately)
Note 7	Past trip 2			FE11	Past trip 2 (displayed alternately)
Note 7	Past trip 3			FE12	Past trip 3 (displayed alternately)
Note 7	Past trip 4			FE13	Past trip 4 (displayed alternately)
Note 7	Past trip 5			FD10	Past trip 5 (displayed alternately)
Note 7	Past trip 6			FD11	Past trip 6 (displayed alternately)
Note 7	Past trip 7			FD12	Past trip 7 (displayed alternately)
Note 7	Past trip 8			FD13	Past trip 8 (displayed alternately)

Refer to page H-8 for notes.

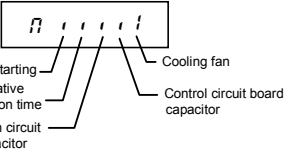
(Continued overleaf)

(Continued)

	Item displayed	Panel operated	LED display	Communication No.	Description
Note 8	Parts replacement alarm information		$n \dots \dots i$	FE79	The ON/OFF status of each of the cooling fan, circuit board capacitor, main circuit capacitor of parts replacement alarm, cumulative operation time or number of starting are displayed in bits. ON: i OFF: \bar{i} 
	Number of starting		$n 3 4.5$	FD32	Number of starting (10000 times)
Note 9	Cumulative operation time		$t 0. 10$	FE14	The cumulative operation time is displayed. (0.1=10 hours, 1.00=100 hours)
	Default display mode		$0 P 2$		The cause of the trip is displayed.

Note 1: The characters to the left disappear above 100 Hz. (Ex: 120 Hz is $i 2 0. 0$)

Note 2: You can switch between % and A (ampere)/V (volt), using the parameter $F 7 0 i$ (current/voltage unit selection).

Note 3: The input (DC) voltage displayed is $1/\sqrt{2}$ times as large as the rectified d.c. input voltage.

Note 4: < VIA bar > $F 1 0 9 = 3, 4$ (Contact input): activated ON/OFF depend on VIA terminal input.

$F 1 0 9 = 0$ to 2 (Analog input): always OFF.

< VIB bar > $F 1 0 9 = i$ to 4 (Contact input): activated ON/OFF depend on VIB terminal input.

$F 1 0 9 = 0$ (Analog input): always OFF.

< S3 bar > $F 1 4 7 = 0$ (Contact input): activated ON/OFF depend on S3 terminal input.

$F 1 4 7 = i$ (PTC input): always OFF.

< S2 bar > $F 1 4 6 = 0$ (Contact input): activated ON/OFF depend on S2 terminal input.

$F 1 4 6 = i$ (Pulse train input): always OFF.

Note 5: < OUT bar > $F 6 6 9 = 0$ (Logic output): activated ON/OFF depend on OUT terminal output.

$F 6 6 9 = i$ (Pulse train output): always OFF.

Note 6: Overload characteristic of inverter and region setting are displayed as following monitor.

$C-x x$: $R U L = i$ (Constant torque characteristic) is selected.

$u-x x$: $R U L = 2$ (Variable torque characteristic) is selected.

$x-E U$: Setup menu is selected to $E U$.

$x-R 5$: Setup menu is selected to $R 5$.

$x-U 5$: Setup menu is selected to $U 5$.

$x-U P$: Setup menu is selected to $U P$.

- Note 7: Past trip records are displayed in the following sequence: 1 (latest trip record) ⇄2⇄3⇄4⇄5⇄6⇄7⇄8 (oldest trip record). If no trip occurred in the past, the message "n E r r" will be displayed. Details on past trip record 1 to 8 can be displayed by pressing the center of the setting dial when past trip 1 to 8 is displayed. Refer to section 8.2.2 for details.
- Note 8: Parts replacement alarm is displayed based on the value calculated from the annual average ambient temperature specified using F 5 3 4, the ON time of the inverter, the operating time of the motor and the output current (load factor). Use this alarm as a guide only, since it is based on a rough estimation.
- Note 9: The cumulative operation time increments only when the machine is in operation.
- Note 10: If there is no trip record, n E r r is displayed.
- Note 11: Of the items displayed on the monitor, the reference values of items expressed in percent are listed below.
- Output current: The current monitored is displayed. The unit can be switched to A (amperes).
 - Input voltage: The voltage displayed is the voltage determined by converting the voltage measured in the DC section into an AC voltage. The reference value (100% value) is 200V (240V class), 400V (500V class). The unit can be switched to V (volts).
 - Output voltage: The voltage displayed is the output command voltage. 100% reference value is 200V. This unit can be switched to V (volts).
 - Load factor of inverter: Depending on the PWM carrier frequency (F 3 3 0) setting and so on, the actual rated current may become smaller than the rated output current indicated on the nameplate. With the actual rated current at that time (after a reduction) as 100%, the proportion of the load current to the rated current is indicated in percent. The load factor is also used to calculate the conditions for overload trip (0 L t).

Note 12: Status monitor of * mark is displayed by *F 7 1 0* to *F 7 1 8* and *F 7 2 0* setting.

The left side character is as following table by each parameter setting number.

Parameter	Setting No.	LED display	Function	Unit	Communication No.
<i>F 7 1 0</i> to <i>F 7 1 8</i> , <i>F 7 2 0</i>	0	<i>o 5 0.0</i>	Operation frequency	Hz / free unit	FE00
	1	<i>£ 1 6.5</i>	Output current *1	% / A	FC02
	2	<i>F 5 0.0</i>	Frequency setting value	Hz / free unit	FE02
	3	<i>Y 1 0 0</i>	Input voltage (DC detection) *1	% / V	FC05
	4	<i>P 9 0</i>	Output voltage (command value) *1	% / V	FC08
	5	<i>h 3.0</i>	Input power	kW	FC06
	6	<i>H 2.8</i>	Output power	kW	FC07
	7	<i>9 8 0</i>	Torque *1	%	FC04
	9	<i>G 6 0</i>	Motor cumulative load factor	%	FE23
	10	<i>L 8 0</i>	Inverter cumulative load factor	%	FE24
	11	<i>r 8 0</i>	PBR (Braking resistor) cumulative load factor	%	FE25
	12	<i>b 5 1.0</i>	Frequency setting value (after compensation)	Hz / free unit	FE15
	13	<i>R 6 5</i>	VIA input value	%	FE35
	14	<i>b 4 5</i>	VIB input value	%	FE36
<i>F 7 1 0</i> , <i>F 7 2 0</i>	18	xxxx	Arbitrary code from communication	-	FA51
<i>F 7 1 0</i> to <i>F 7 1 8</i> , <i>F 7 2 0</i>	20	<i>£ 3 5</i>	VIC input value	%	FE37
	21	<i>P 0.8 0</i>	Pulse train input value	kpps	FE56
	23	<i>d 4 0.0</i>	PID feedback value	Hz / free unit	FE22
	24	<i>h 3 5 6</i>	Input power	kWh	FE76
	25	<i>h 3 4 8</i>	Output power	kWh	FE77
	26	<i>G 7 5</i>	Motor load factor	%	FE26
	27	<i>L 7 0</i>	Inverter load factor	%	FE27
	28	<i>R 3 3.0</i>	Inverter rated current	A	FE70
	29	<i>F 7 0</i>	FM output value	%	FE40
	30	<i>P 0.8 0</i>	Pulse train output value	kpps	FD40
	31	<i>P 3 4.5</i>	Cumulative power on time	100 hours	FE80
	32	<i>F 2 8.5</i>	Cumulative fan operation time	100 hours	FD41
	33	<i>£ 2 7.7</i>	Cumulative operation time	100 hours	FE14
	34	<i>n 8 9.0</i>	Number of starting	10000 times	FD32
	35	<i>F 4 5.5</i>	Forward number of starting	10000 times	FD33
	36	<i>r 4 3.5</i>	Reverse number of starting	10000 times	FD34
40	<i>R 3 3.0</i>	Inverter rated current (Carrier frequency corrected)	A	FD70	

*1: These monitor values can be filtered by *F 7 4 6* setting. Refer to section 6.29.7.

9. Measures to satisfy the standards

9.1 How to cope with the CE directive

In Europe, the EMC directive and the low-voltage directive, which took effect in 1996 and 1997, respectively, made it obligatory to put the CE mark on every applicable product to prove that it complies with the directives. Inverters do not work alone but are designed to be installed in a control panel and always used in combination with other machines or systems which control them. So they themselves were not considered to be subject to the EMC directive. However the component also becomes to be applied to the new EMC directive since 2007. For this reason, the CE mark must be put on all inverters because they are subject to the low-voltage directive.

The CE mark must be put on all machines and systems with built-in inverters because such machines and systems are subject to the above directives. It is the responsibility of the manufacturers of such final products to put the CE mark on each one. If they are "final" products, they might also be subject to machine-related directives. It is the responsibility of the manufacturers of such final products to put the CE mark on each one. In order to make machines and systems with built-in inverters compliant with the EMC directive and the low-voltage directive, this section explains how to install inverters and what measures should be taken to satisfy the EMC directive.

We have tested representative models with them installed as described later in this manual to check for conformity with the EMC directive. However, we cannot check all inverters for conformity because whether or not they conform to the EMC directive depends on how they are installed and connected. In other words, the application of the EMC directive varies depending on the composition of the control panel with a built-in inverter(s), the relationship with other built-in electrical components, the wiring condition, the layout condition, and so on. Therefore, please verify yourself whether your machine or system conforms to the EMC directive.

9.1.1 About the EMC directive

The CE mark must be put on every final product that includes an inverter(s) and a motor(s). In this series of inverters are equipped with an EMI filter and complies with the EMC directive if wiring is carried out correctly.

- EMC directive
2004/108/EC

The EMC standards are broadly divided into two categories; immunity- and emission-related standards, each of which is further categorized according to the operating environment of each individual machine. Since inverters are intended for use with industrial systems under industrial environments, they fall within the EMC categories listed in Table 1 below. The tests required for machines and systems as final products are almost the same as those required for inverters.

Table 1 EMC standards

Category	Subcategory	Product standards	Test standard
Emission	Radiation noise	IEC 61800-3	CISPR11(EN55011)
	Conductive noise		CISPR11(EN55011)
Immunity	Static discharge		IEC61000-4-2
	Radioactive radio-frequency magnetic contactor field		IEC61000-4-3
	First transient burst		IEC61000-4-4
	Surge		IEC61000-4-5
	Radio-frequency induction/transmission interference		IEC61000-4-6
	Voltage dip/Interruption of power		IEC61000-4-11

9.1.2 Measures to satisfy the EMC directive

This subsection explains what measures must be taken to satisfy the EMC directive.

- (1) This inverter is equipped with an EMC filter.

Table 2 Combinations of inverter and EMC filter

Single-phase 240 V class

Combination of inverter and filter		
Inverter type	Conductive noise IEC61800-3, category C2 (PWM carrier frequency of 4kHz and motor wiring length of 10m or less)	Conductive noise IEC61800-3, category C2 (PWM carrier frequency of 12kHz and motor wiring length of 5m or less)
VFMB1S-2002PL	Built-in filter	Built-in filter
VFMB1S-2004PL		
VFMB1S-2007PL		
VFMB1S-2015PL		
VFMB1S-2022PL		

Three-phase 500 V class

Combination of inverter and filter			
Inverter type	Transmission noise IEC61800-3, category C2 (PWM carrier frequency of 4kHz and motor wiring length of 10m or less)	Transmission noise IEC61800-3, category C2 (PWM carrier frequency of 12kHz and motor wiring length of 5m or less)	Transmission noise IEC61800-3, category C3 (PWM carrier frequency of 12kHz and motor wiring length of 25m or less)
VFMB1-4004PL	Built-in filter	Built-in filter	-
VFMB1-4007PL			
VFMB1-4015PL			
VFMB1-4022PL			
VFMB1-4037PL			
VFMB1-4055PL	-	-	Built-in filter
VFMB1-4075PL			
VFMB1-4110PL			
VFMB1-4150PL			

- (2) Use shielded power cables, such as inverter output cables, and shielded control cables. Route the cables and wires so as to minimize their lengths. Keep a distance between the power cable and the control cable and between the input and output wires of the power cable. Do not route them in parallel or bind them together, instead cross at right angle.
- (3) It is more effective in limiting the radiation noise to install the inverter in a sealed steel cabinet. Using wires as thick and short as possible, earth the metal plate and the control panel securely with a distance kept between the earth cable and the power cable.
- (4) Route the input and output wires apart from each other.
- (5) To suppress radiation noise from cables, ground all shielded cables through a noise cut plate.
It is effective to earth shielded cables in the vicinity of the inverter and cabinet (within a radius of 10cm from each of them). Inserting a ferrite core in a shielded cable is even more effective in limiting the radiation noise.
- (6) To further limit the radiation noise, insert a zero-phase reactor in the inverter output line and insert ferrite cores in the earth cables of the metal plate and cabinet.

[Example of wiring]

VFMB1S-2002 to 2022PL, VFMB1-4004 to 4037PL

9

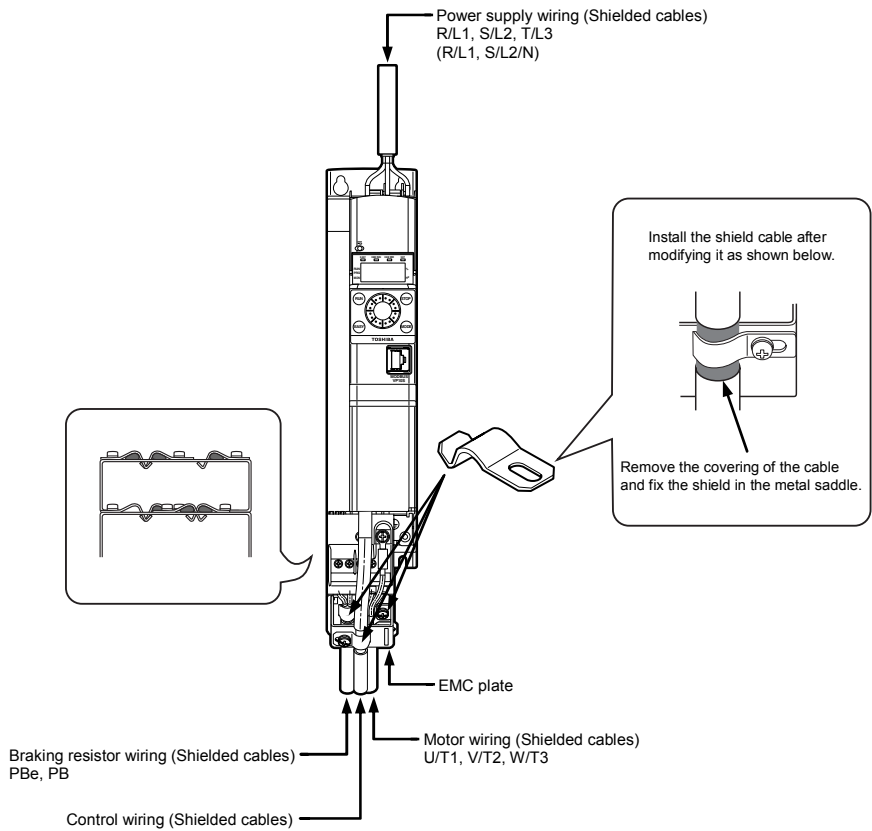

VFMB1-4055 to 4150PL

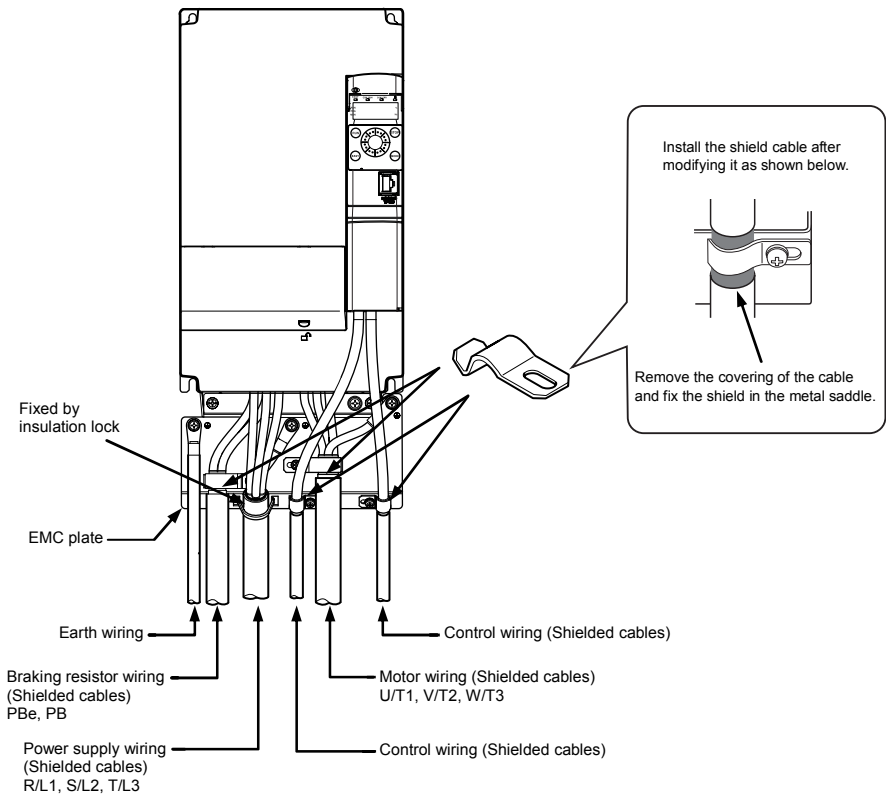

9.1.3 About the low-voltage directive

The low-voltage directive provides for the safety of machines and systems. All Toshiba inverters are CE-marked in accordance with the standard EN 50178 specified by the low-voltage directive, and can therefore be installed in machines or systems and imported without problem to European countries.

Applicable standard: IEC61800-5-1

Pollution level: 2

Overvoltage category: 3

9.1.4 Measures to satisfy the low-voltage directive

When incorporating the inverter into a machine or system, it is necessary to take the following measures so that the inverter satisfies the low-voltage directive.

- (1) Install the inverter in a cabinet and ground the inverter enclosure. When doing maintenance, be extremely careful not to put your fingers into the inverter through a wiring hole and touch a charged part, which may occur depending on the model and capacity of the inverter used.
- (2) Connect earth wiring to the earth terminal on the EMC plate. Or install the EMC plate (attached as standard) and another cable connect to earth terminal on the EMC plate. Refer to the table in 10.1 for details about earth cable sizes.
- (3) Install a non-fuse circuit breaker or a fuse on the input side of the inverter. (Refer to section 10.1 and 9.2.3)

9.2 Compliance with UL Standard and CSA Standard

This inverter that conform to the UL Standard and CSA Standard have the UL/CSA mark on the nameplate.

9.2.1 Compliance with Installation

A UL certificate was granted on the assumption that the inverter would be installed in a cabinet. Therefore, install the inverter in a cabinet and if necessary, take measures to maintain the ambient temperature (temperature in the cabinet) within the specified temperature range. (Refer to section 1.4.4)

9.2.2 Compliance with Connection

Use the UL conformed cables (Rating 75 °C or more, Use the copper conductors only.) to the main circuit terminals (R/L1, S/L2, S/L2/N, T/L3, U/T1, V/T2, W/T3, PB, PBe, PA/+, PC/-).

For instruction in the United States, Integral solid state short circuit protection does not provide branch circuit protection. Branch circuit protection must be provided in accordance with the National Electrical Code and any additional local codes.

For instruction in the Canada, Integral solid state short circuit protection does not provide branch circuit protection.

Branch circuit protection must be provided in accordance with the Canadian Electrical Code and any additional local codes.

9.2.3 Compliance with Peripheral devices

Use the UL listed fuses at connecting to power supply.

Short circuit test is performed under the condition of the power supply short-circuit currents in below.

These interrupting capacities and fuse rating currents depend on the applicable motor capacities.

■ AIC, Fuse and Wire sizes

Inverter model	Voltage (V)	Input withstand rating (kA)	Output Interrupt rating (kA)	Branch circuit protection	Rating (A)	Cable sizes of power circuit	Earth Cable
Marking	Y	(1)	X (2)	Z1	Z2	-	-
VFMB1S-2002PL	240	1	5	Class CC	7	AWG 14	AWG 14
VFMB1S-2004PL	240	1	5	Class J	15	AWG 14	AWG 14
VFMB1S-2007PL	240	1	5	Class J	25	AWG 14	AWG 14
VFMB1S-2015PL	240	1	5	Class J	40	AWG 10	AWG 12
VFMB1S-2022PL	240	1	5	Class J	45	AWG 10	AWG 10
VFMB1-4004PL	500	5	5	Class CC	6	AWG 14	AWG 14
VFMB1-4007PL	500	5	5	Class CC	6	AWG 14	AWG 14
VFMB1-4015PL	500	5	5	Class CC	12	AWG 14	AWG 14
VFMB1-4022PL	500	5	5	Class J	15	AWG 14	AWG 14
VFMB1-4037PL	500	5	5	Class J	25	AWG 12	AWG 14
VFMB1-4055PL	500	22	22	Class J	40	AWG 10	AWG 10
VFMB1-4075PL	500	22	22	Class J	40	AWG 8	AWG 10
VFMB1-4110PL	500	22	22	Class J	60	AWG 8	AWG 10
VFMB1-4150PL	500	22	22	Class J	70	AWG 6	AWG 10

Suitable for use on a circuit capable of delivering not more than X rms symmetrical kilo Amperes, Y Volts maximum, when protected by Z1 with a maximum rating of Z2 .

(1) Input withstand rating is that for which the product has been designed thermally. Installation on a supply greater than this level will require additional inductance to satisfy this level.

(2) Output interrupt rating relies on Integral solid state short circuit protection. This does not provide branch circuit protection. Branch circuit protection must be provided in accordance with the National Electrical Code and any additional local codes. This is dependant on the type of installation.

9.2.4 Motor thermal protection

Selects the electronic thermal protection characteristics that fit with the ratings and characteristics of the motor. (Refer to section 3.5)

In case of multi motor operation with one inverter, thermal relay should be connected to each motor.

9.3 Compliance with safety standards

This inverter has the "Safe Torque Off" safety function that complies with safety standards.

To ensure safety performance, however, the mechanical system with which this inverter is used has to adhere to such standards as a whole.

To be more specific, in order for the system to satisfy the following safety standards, it needs to be configured, as shown on the next page, with the Safe Torque Off terminal (STO terminal on the control terminal board) so that it will coast or decelerate to a stop in the event of a failure.

To ensure that the motor coasts or decelerates to a stop if an unusual event occurs, the Safe Torque Off circuit is designed with redundancy and it has a diagnosis circuit that determines whether the unusual event is at a permissible level or not, in addition to a hardware circuit and software that cut off the operation signal if the unusual event is judged impermissible. This safety function is certified by the certification organization "INERIS."

- This inverter meets the IEC/EN61508 SIL2 requirements.
(The term "SIL" is an acronym for "Safety Integrity Level," which is a safety performance scale.)
- This inverter falls under Category 3 of the safety standard EN954-1 for mechanical systems.
- This inverter supports the two stopping methods defined in IEC/EN61800-5-2.
One is "STO" which refers to "coast and stop".

EN61508 is an international standard that defines safety performance required for systems provided with electric and electronic programmable devices, and SIL2 applies to systems that are configured with dangerous failure rates of as low as 10^{-6} to 10^{-7} , as shown in the table below. For the relationship between SIL and inverter configuration, see the following pages.

<<Target for IEC/EN61508 safety performance scale>>

SIL	Heavy-duty operation mode or continuous operation mode (Hourly dangerous failure rate)
4	$10^{-9} \sim 10^{-8}$
3	$10^{-8} \sim 10^{-7}$
2	$10^{-7} \sim 10^{-6}$
1	$10^{-6} \sim 10^{-5}$

The European standard EN954-1, a basic safety standard for mechanical system, categorizes machines by degree of danger.

Placed in Category 3 are machines that are designed with redundancy so that a single failure will not cause a degradation in their safety performance.

For the relationship between each category and the safety function, see the table below.

<<Categories relating to safety according to EN 954-1>>



Categories	Basic safety principle	Control system requirements	Behavior in the event of a fault
B	Selection of components that conform to relevant standards.	Control in accordance with good engineering practice.	Possible loss of safety function.
1	Selection of components and basic safety principles.	Use of tried and tested components and proven safety principles.	Possible loss of safety function, but with less probability of this than with B.
2	Selection of components and basic safety principles.	Cyclic testing. The test intervals must be suited to the machine and its applications.	Fault detected at each test.
3	Structure of the safety circuits.	A single fault must not cause loss of the safety function. This single fault must be detected if reasonably practicable.	Safety function ensured, except in the event of an accumulation of faults.
4	Structure of the safety circuits.	A single fault must not cause loss of the safety function. This fault must be detected at or before the next demand on the safety function. An accumulation of faults must not cause loss of the safety function.	Safety function always ensured.

The three stopping methods described on the following pages were selected in accordance with IEC60204-1.

Stopping method 1 (Stop category 0): Stops the mechanical system by cutting off the power supply immediately.

Stopping method 2 (Stop category 1): First controls the mechanical system to stop it, and then cuts off the power supply.

Stopping method 3 (Stop category 2): First cut off the power supply, and then controls the mechanical system to stop it.

 Caution	
 Mandatory action	For preventive maintenance, check at least once a year whether the Safe Torque Off safety function operates normally.

Safety category1:	EN954-1 category1, IEC/EN61508, SIL1
Stop category1:	IEC/EN60204-1
Coast stop under the control of the MC in the main circuit	

(1) An example of connection for operation in sink mode (common: CC)

- In this connection, the STO terminal is not used. This connection falls under Stop Category 0 defined in IEC/EN60204-1.

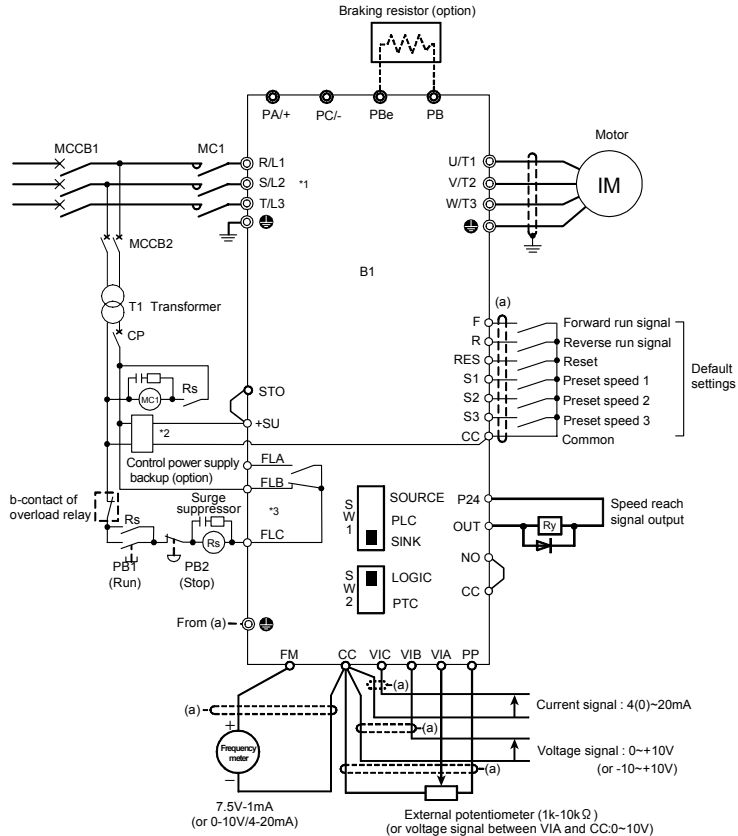

9

Symbols	Description
B1	VF-MB1 inverter
MCCB1	Circuit breaker
MC1	Magnetic condactor
MCCB2	Circuit breaker for control transformer
T1	Control transformer 400/200V (For 400V class only)
CP	Circuit protector
PB1	Push button switch (Run)
PB2	Push button switch (Stop/emergency stop)
Rs	Control relay

*1: Single-phase models are R/L1 and S/L2/N terminals.

*2: To back up the inverter's internal power supply that supplies control power, an external control power backup device (CPS002Z - optional) is required. The optional control power backup device can be used with both 240V and 500V classes.

*3: By default, the FL relay is set as a failure FL output relay.

Safety category1: EN954-1 category1, IEC/EN61508, SIL1
 Stop category0: IEC/EN60204-1

Coast stop under the control of the MC in the main circuit

(2) An example of connection for operation in source mode (common: P24)

- In this connection, the STO terminal is not used. This connection falls under Stop Category 0 defined in IEC/EN60204-1.

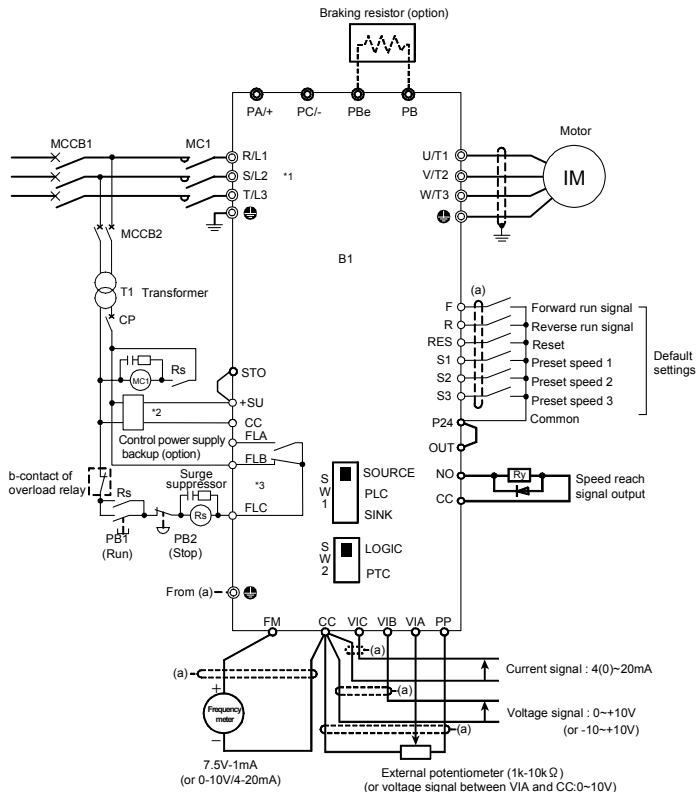

Symbols	Description
B1	VF-MB1 inverter
MCCB1	Circuit breaker
MC1	Magnetic condactor
MCCB2	Circuit breaker for control transformer
T1	Control transformer 400/200V (For 400V class only)
CP	Circuit protector
PB1	Push button switch (Run)
PB2	Push button switch (Stop/emergency stop)
Rs	Control relay

*1: Single-phase models are R/L1 and S/L2/N terminals.

*2: To back up the inverter's internal power supply that supplies control power, an external control power backup device (CPS002Z - optional) is required. The optional control power backup device can be used with both 240V and 500V classes.

*3: By default, the FL relay is set as a failure FL output relay.

Symbols	Description
B1	VF-MB1 inverter
MCCB1	Circuit breaker
B2	Safety relay: XPS-AC (manufactured by Schneider Electric)
F1	Fuse
Pb1	Push button switch 2b contact (for emergency stop)
Pb2	Push button switch (for reset and start)

*1: Single-phase models are R/L1 and S/L2/N terminals.

*2: Supply voltage: AC/DC24V, AC48V, AC115V, AC230V

*3: If an emergency stop command is issued, the STO terminal will be turned off to coast and stop the motor.

*4: Pb2 is used to reset/start the inverter after the power is turned on or in the event of an emergency stop.

ESC is used to set reset/start conditions for the external device.

*5: To connect a safety relay to the STO terminal, use a coaxial cable RG174/U (MIL-C17) or KX3B (NFC93-550) 2.54 mm or more in outside diameter and 2 m or less in length. When using a shielded cable, ground it.

Safety category3:	EN954-1 category3, IEC/EN61508, SIL2
Stop category0:	IEC/EN60204-1
Coast stop under the control of STO	

(4) An example of connection for operation in source mode (common: P24)

- In this connection, the STO terminal is used to connect a safety device. The emergency stop circuit is supervised by the external safety relay. This safety relay can be shared among several inverters.
- If the STO terminal is turned off, the motor will coast and stop. This operation falls under Stop Category 0 defined in IEC/EN60204-1.
- The motor is prevented from restarting automatically before the STO terminal is turned back on.
- When using the inverter to control the operation of a mechanical brake (for example, when using with a hoist or crane), connect the cable from the output terminal of the safety relay to the brake control circuit.

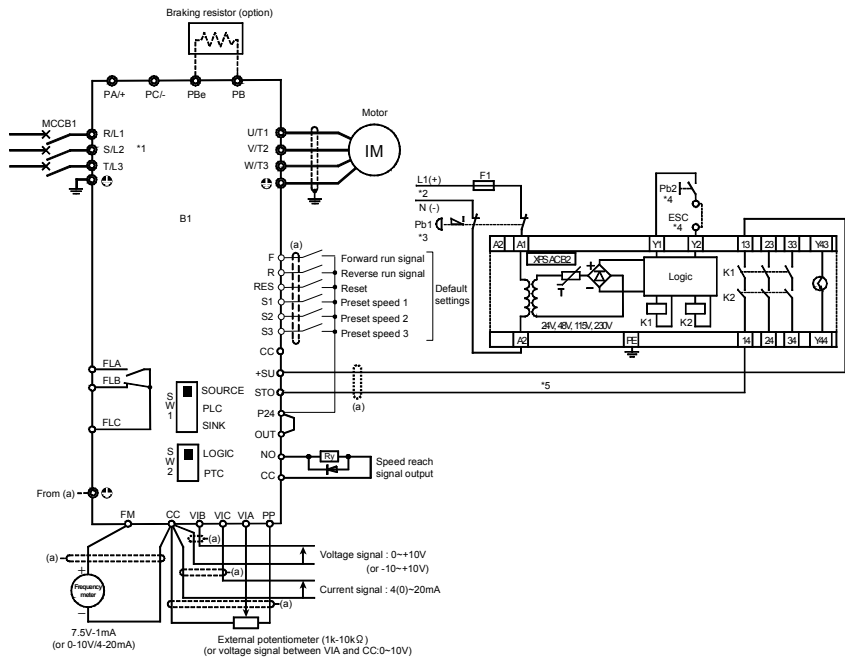

9

Symbols	Description
B1	VF-MB1 inverter
MCCB1	Circuit breaker
B2	Safety relay: XPS-AC (manufactured by Schneider Electric)
F1	Fuse
Pb1	Push button switch 2b contact (for emergency stop)
Pb2	Push button switch (for reset and start)

*1: Single-phase models are R/L1 and S/L2/N terminals.

*2: Supply voltage: AC/DC24V, AC48V, AC115V, AC230V

*3: If an emergency stop command is issued, the STO terminal will be turned off to coast and stop the motor.

*4: Pb2 is used to reset/start the inverter after the power is turned on or in the event of an emergency stop.
ESC is used to set reset/start conditions for the external device.

*5: To connect a safety relay to the STO terminal, use a coaxial cable RG174/U (MIL-C17) or KX3B (NFC93-550) 2.54 mm or more in outside diameter and 2 m or less in length. When using a shielded cable, ground it.

Safety category3:	EN954-1 category3, IEC/EN61508, SIL2
Stop category1:	IEC/EN60204-1
Deceleration stop under the control of STO	

(5) An example of connection for operation in sink mode (common: CC)

- In this connection, the STO terminal is used to connect a safety device. The emergency stop circuit is supervised by the external safety relay. This safety relay can be shared among several inverters.
- In the event of an emergency stop, the external safety relay issues a deceleration command to the inverter. At this command, the motor deceleration stops. Then, the safety relay turns off the STO terminal on expiration of the time limit (max. 30 sec) set for the relay. This operation falls under Stop Category 1 defined in IEC/EN60204-1.
- For this connection, the function of issuing the forward run command (2) needs to be assigned to the F terminal, and the function of issuing the reverse run command (4) to the R terminal.

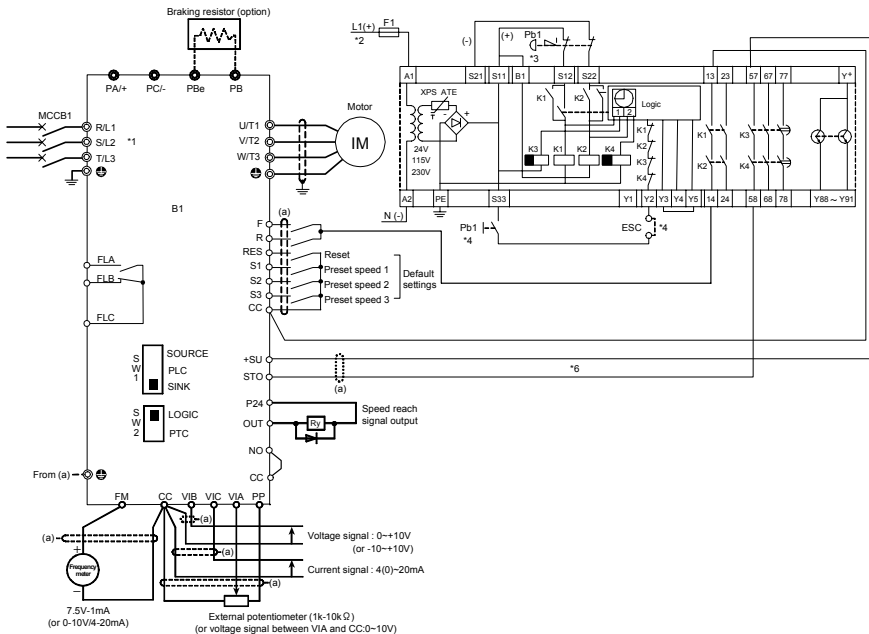

9

Symbols	Description
B1	VF-MB1 inverter
MCCB1	Circuit breaker
B2	Safety relay: XPS-ATE (manufactured by Schneider Electric)
F1	Fuse
Pb1	Push button switch 2b contact (for emergency stop)
Pb2	Push button switch (for reset and start)

*1: Single-phase models are R/L1 and S/L2/N terminals.

*2: Supply voltage: AC/DC24V, AC48V, AC115V, AC230V

*3: If an emergency stop command is issued, the STO terminal will be turned off to coast and stop the motor.

*4: Pb2 is used to reset/start the inverter after the power is turned on or in the event of an emergency stop. ESC is used to set reset/start conditions for the external device.

*5: If a deceleration time of more than 30 seconds is required, use a safety relay XPS-AV, which allows you to set the deceleration time at a maximum of 300 seconds.

*6: To connect a safety relay to the STO terminal, use a coaxial cable RG174/U (MIL-C17) or KX3B (NFC93-550) 2.54 mm or more in outside diameter and 2 m or less in length. When using a shielded cable, ground it.

Safety category3:	EN954-1 category3, IEC/EN61508, SIL2
Stop category1:	IEC/EN60204-1
Deceleration stop under the control of STO	

(6) An example of connection for operation in source mode (common: P24)

- In this connection, the STO terminal is used to connect a safety device. The emergency stop circuit is supervised by the external safety relay. This safety relay can be shared among several inverters.
- In the event of an emergency stop, the external safety relay issues a deceleration command to the inverter. At this command, the motor slows down and stops. Then, the safety relay turns off the STO terminal on expiration of the time limit (max. 30 sec) set for the relay. This operation falls under Stop Category 1 defined in IEC/EN60204-1.
- For this connection, the function of issuing the forward run command (2) needs to be assigned to the F terminal, and the function of issuing the reverse run command (4) to the R terminal.

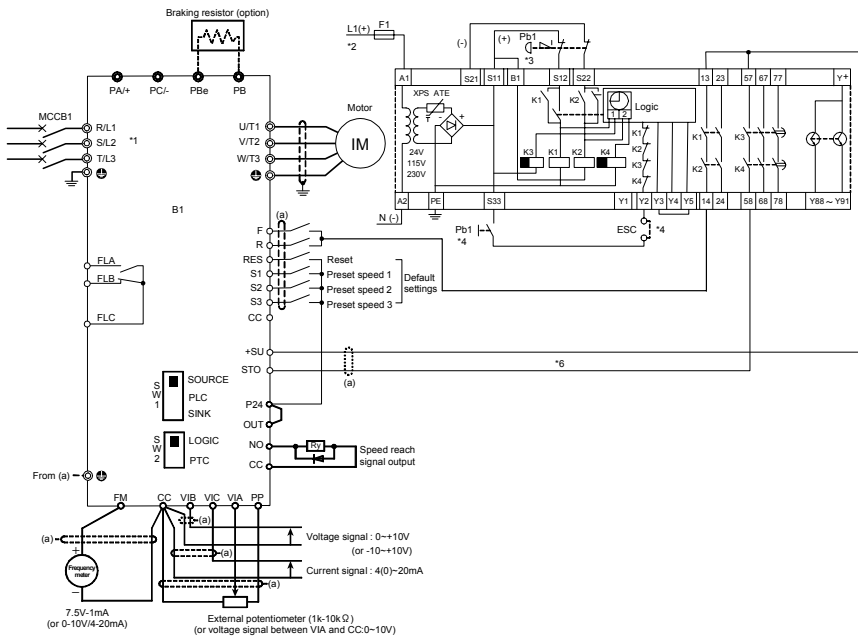

Symbols	Description
B1	VF-MB1 inverter
MCCB1	Circuit breaker
B2	Safety relay: XPS-ATE (manufactured by Schneider Electric)
F1	Fuse
Pb1	Push button switch 2b contact (for emergency stop)
Pb2	Push button switch (for reset and start)

*1: Single-phase models are R/L1 and S/L2/N terminals.

*2: Supply voltage: AC/DC24V, AC48V, AC115V, AC230V



*3: If an emergency stop command is issued, the STO terminal will be turned off to coast and stop the motor.

*4: Pb2 is used to reset/start the inverter after the power is turned on or in the event of an emergency stop. ESC is used to set reset/start conditions for the external device.

*5: If a deceleration time of more than 30 seconds is required, use a safety relay XPS-AV, which allows you to set the deceleration time at a maximum of 300 seconds.

*6: To connect a safety relay to the STO terminal, use a coaxial cable RG174/U (MIL-C17) or KX3B (NFC93-550) 2.54 mm or more in outside diameter and 2 m or less in length. When using a shielded cable, ground it.

10. Peripheral devices

 Warning	
 Mandatory action	<ul style="list-style-type: none"> When using switchgear for the inverter, it must be installed in a cabinet. Failure to do so can lead to risk of electric shock and can result in death or serious injury.
 Be Grounded	<ul style="list-style-type: none"> Connect earth cables securely. Failure to do so can lead to risk of electric shock or fire in case of a failure or short-circuit or electric leak.

10.1 Selection of wiring materials and devices

Voltage class	Capacity of applicable motor (kW)	Inverter model	Wire size (See Note 4)					
			Power circuit (mm ²) (Note 1.)		Braking resistor (optional) (mm ²)		Earth cable (mm ²)	
			IEC compliant	For Japan (JEAC800 1-2005)	IEC compliant	For Japan (JEAC800 1-2005)	IEC compliant	For Japan (JEAC800 1-2005)
Single-phase 240V class	0.2	VFMB1S-2002PL	1.5	2.0	1.5	2.0	2.5	2.0
	0.4	VFMB1S-2004PL	1.5	2.0	1.5	2.0	2.5	2.0
	0.75	VFMB1S-2007PL	1.5	2.0	1.5	2.0	2.5	2.0
	1.5	VFMB1S-2015PL	2.5	2.0	1.5	2.0	2.5	2.0
	2.2	VFMB1S-2022PL	4.0	2.0	1.5	2.0	4.0	3.5
Three-phase 500V class	0.4	VFMB1-4004PL	1.5	2.0	1.5	2.0	2.5	2.0
	0.75	VFMB1-4007PL	1.5	2.0	1.5	2.0	2.5	2.0
	1.5	VFMB1-4015PL	1.5	2.0	1.5	2.0	2.5	2.0
	2.2	VFMB1-4022PL	1.5	2.0	1.5	2.0	2.5	2.0
	4.0	VFMB1-4037PL	2.5	2.0	1.5	2.0	2.5	2.0
	5.5	VFMB1-4055PL	4.0	2.0	1.5	2.0	4.0	3.5
	7.5	VFMB1-4075PL	6.0	3.5	2.5	2.0	6.0	3.5
	11	VFMB1-4110PL	10.0	5.5	4.0	2.0	10.0	5.5
	15	VFMB1-4150PL	16.0	8.0	6.0	3.5	16.0	5.5

Note 1: Sizes of the wires connected to the input terminals R/L1, S/L2 and T/L3 (Single-phase models are R/L1 and S/L2/N) and the output terminals U/T1, V/T2 and W/T3 when the length of each wire does not exceed 30m. If there is a need to bring the inverter into UL compliance, use wires specified in chapter 9.

Note 2: For the control circuit, use shielded wires 0.75 mm² or more in diameter.

Note 3: For grounding, use a cable with a size equal to or larger than the above.

Note 4: The wire sizes specified in the above table apply to HIV wires (copper wires shielded with an insulator with a maximum allowable temperature of 75°C) used at an ambient temperature of 50°C or less.

Note 5: If there is a need to bring the inverter into \underline{UL} compliance, use wires specified in chapter 9.

■ Selection of wiring devices

Voltage class	Applicable motor (kW)	Input current (A)		Molded case circuit breaker (MCCB) Earth leakage circuit breaker (ELCB)				Magnetic contactor (MC)			
		w/o reactor	With ACL	Without reactor		with ACL		Without reactor		with ACL	
				Rated current (A)	MCCB type (ELCB type)	Rated current (A)	MCCB type (ELCB type)	Rated current (A)	Model	Rated current (A)	Model
Single-phase 240V class	0.2	3.4	2.4	5	NJ30E (NJV30E)	5	NJ30E (NJV30E)	13	CA13	13	CA13
	0.4	6.0	4.4	10		5		13		13	
	0.75	10.1	8.1	15		10		13		13	
	1.5	17.6	15.3	20		15		19	CA20	13	
	2.2	23.9	21.3	30		30		25	CA25	19	CA20
	0.4	2.1	1.5	5		5		NJ30E (NJV30E)	9	CA13	9
0.75	3.6	2.6	5	5	9	9					
1.5	6.5	4.7	10	10	9	9					
2.2	8.7	6.4	15	10	9	9					
4.0	13.7	10.3	20	15	9	9					
5.5	20.7	14.0	30	20	17	9					
7.5	26.5	18.1	30	30	17	CA20	17				
11	36.6	24.1	50	NJ50EB (NJV50EB)	40	NJ50EB (NJV50EB)	25		CA25	17	CA20
15	47.3	36.6	60	NJ100FB (NJV100FB)	50		32	CA35	25	CA25	

Note 1: Models made by Toshiba Industrial Products Sales Corporation are shown.

Note 2: Be sure to attach a surge killer to the exciting coil of the relay and the magnetic contactor.

Note 3: When using the auxiliary contacts 2a of the magnetic contactor MC for the control circuit, connect the contacts 2a in parallel to increase reliability.

Note 4: When a motor is driven by commercial power supply using commercial power supply / inverter switching circuit, use a magnetic contactor appropriated AC-3 class the motor rated current.

Note 5: Select an MCCB with a current breaking rating appropriate to the capacity of the power supply, because short-circuit currents vary greatly depending on the capacity of the power supply and the condition of the wiring system. The MCCB, MC and ELCB in this table were selected, on the assumption that a power supply with a normal capacity would be used.

Note 6: For the operation and control circuits, regulate the voltage at 200V to 240V with a stepdown transformer for 500V class.

10.2 Installation of a magnetic contactor

If using the inverter without installing a magnetic contactor (MC) in the primary circuit, use an MCCB (with a power cutoff device) to open the primary circuit when the inverter protective circuit is activated.

When using an optional brake module, install a magnetic contactor (MC) or non-fuse circuit breaker with a power cutoff device on the primary power supply of the inverter, so that the power circuit opens when the failure detection relay (FL) in the inverter or the externally installed overload relay is actuated.

■ Magnetic contactor in the primary circuit

To detach the inverter from the power supply in any of the following cases, insert a magnetic contactor (primary-side magnetic contactor) between the inverter and the power supply.

- (1) If the motor overload relay is tripped
- (2) If the protective detector (FL) built into the inverter is activated
- (3) In the event of a power failure (for prevention of auto-restart)
- (4) If the resistor protective relay is tripped when a braking resistor and braking module (option) are used

When using the inverter with no magnetic contactor (MC) on the primary side, install a non-fuse circuit breaker with a voltage tripping coil instead of an MC and adjust the circuit breaker so that it will be tripped if the protective relay referred to above is activated. To detect a power failure, use an undervoltage relay or the like.

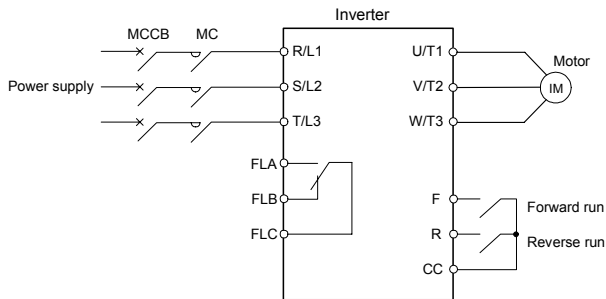

Example of connection of a magnetic contactor in the primary circuit

Notes on wiring

- When frequently switching between start and stop, do not use the magnetic contactor on the primary side as an on-off switch for the inverter.
Instead, stop and start the inverter by using terminals F and CC (forward run) or R and CC (reverse run).
- Be sure to attach a surge killer to the exciting coil of the magnetic contactor (MC).

■ Magnetic contactor in the secondary circuit

A magnetic contactor may be installed on the secondary side to switch controlled motors or supply commercial power to the load when the inverter is out of operation.

Notes on wiring

- Be sure to interlock the magnetic contactor on the secondary side with the power supply to prevent commercial power from being applied to the inverter output terminals.
- When installing a magnetic contactor (MC) between the inverter and the motor, avoid turning the magnetic contactor on or off during operation. Turning the magnetic contactor on or off during operation causes a current to rush into the inverter which could lead to malfunction.

10.3 Installation of an overload relay

- 1) This inverter has an electronic-thermal overload protective function.
In the following cases, however, an overload relay suitable for the adjustment of the motor electronic thermal protection level (I_{th}) and appropriate to the motor used should be installed between the inverter and the motor.
 - When using a motor with a current rating different to that of the corresponding Toshiba general-purpose motor
 - When operating a single motor with an output smaller than that of the applicable standard motor or more than one motor simultaneously.
- 2) When using this inverter to operate a constant-torque motor, such as the Toshiba VF motor, adjust the protection characteristic of the electronic thermal protection unit (I_{th}) to the VF motor use.
- 3) It is recommended to use a motor with a thermal relay embedded in the motor coil to give sufficient protection to the motor, especially when it runs in a low-speed range.

10.4 Optional external devices

The following external devices are optionally available for this inverter series.

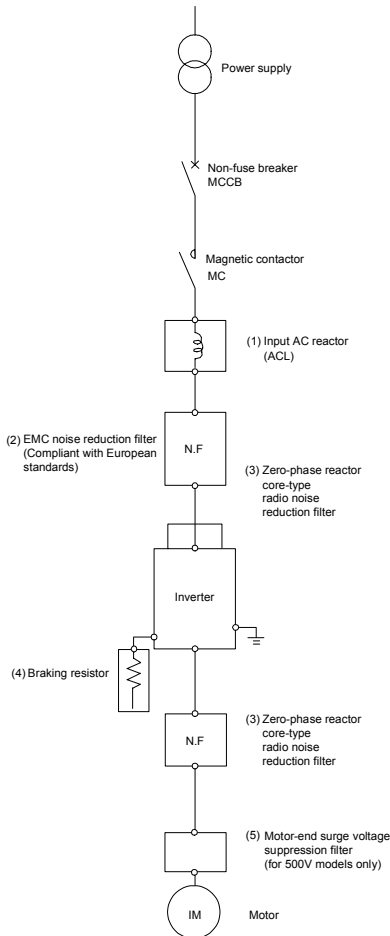

- | | |
|---|------------|
| (6) Parameter writer | : RKP002Z |
| (7) Remote keypad | : RKP007Z |
| (8) Remote control panel | : CBVR-7B1 |
| (9) Frequency meter | : QS60T |
| (10) FRH kit | : FRH kit |
| (11) USB communication converter | : USB001Z |
| (12) Profibus DP communication option | : PDP003Z |
| (13) DeviceNet communication option | : DEV003Z |
| (14) EtherNet IP/ Modbus TCP communication option | : IPE002Z |

11. Table of parameters and data

11.1 Frequency setting parameter

Title	Function	Unit	Minimum setting unit Panel/Communication	Adjustment range	Default setting	User setting	Reference
<i>F₀</i>	Operation frequency of operation panel	Hz	0.1/0.01	L-L-U/L	0.0		3.2.2

11.2 Basic parameters

- Five navigation functions

Title	Communication No.	Function	Unit	Minimum setting unit Panel/Communication	Adjustment range	Default setting	User setting	Reference
<i>R₀H</i>	-	History function	-	-	Displays parameters in groups of five in the reverse order to that in which their settings were changed. * (Possible to edit)	-		4.3 5.1
<i>R₀F</i>	0093	Guidance function	-	-	0: - 1: - 2: Preset speed guidance 3: Analog signal operation guidance 4: Motor 1 & 2 switching operation guidance 5: Motor constant setting guidance	0		4.3 5.2
<i>R₀L</i>	0094	Overload characteristic selection	-	-	0: - 1: Constant torque characteristic (150%-60s) 2: Variable torque characteristic (120%-60s)	0		3.5 5.3 6.14
<i>R₀I</i>	0000	Automatic acceleration/ deceleration	-	-	0: Disabled (manual setting) 1: Automatic 2: Automatic (only at acceleration)	0		5.4
<i>R₀P</i>	0001	Torque boost setting macro function	-	-	0: Disabled 1: Automatic torque boost + auto-tuning 2: Vector control + auto-tuning 3: Energy saving + auto-tuning	0		5.5

• Basic parameters

Title	Communication No.	Function	Unit	Minimum setting unit Panel/Communication	Adjustment range	Default setting	User setting	Reference
$C\bar{M}D$	0003	Command mode selection	-	-	0: Terminal board 1: Panel keypad (including remote keypad) 2: RS485 communication 3: CANopen communication 4: Communication option	1		3.2 5.6 7.3
$F\bar{N}D$	0004	Frequency setting mode selection 1	-	-	0: Setting dial 1(save even if power is off) 1: Terminal board VIA 2: Terminal board VIB 3: Setting dial 2(press in center to save) 4: RS485 communication 5: UP/DOWN from external logic input 6: CANopen communication 7: Communication option 8: Terminal board VIC 9, 10: - 11: Pulse train input	0		3.2 5.6 6.3.4 6.6.1 7.3
$F\bar{N}S$	0005	Meter selection	-	-	0: Output frequency 1: Output current 2: Frequency reference 3: Input voltage (DC detection) 4: Output voltage (command value) 5: Input power 6: Output power 7: Torque 8: - 9: Motor cumulative load factor 10: Inverter cumulative load factor 11: PBR (Braking resistor) cumulative load factor 12: Frequency setting value (after compensation) 13: VIA input value 14: VIB input value 15: Fixed output 1 (output current 100% equivalent) 16: Fixed output 2 (output current 50% equivalent) 17: Fixed output 3 (Other than the output current) 18: RS485 communication data 19: For adjustments ($F\bar{N}$ set value is displayed.) 20: VIC input value 21: Pulse train input value 22: - 23: PID feedback value 24: Integral input power 25: Integral output power	0		3.4 5.7
$F\bar{N}$	0006	Meter adjustment gain	-	-	-	-		
$F\bar{r}$	0008	Forward/reverse run selection (Panel keypad)	-	-	0: Forward run 1: Reverse run 2: Forward run (F/R switching on remote keypad) 3: Reverse run (F/R switching on remote keypad)	0		5.8

Title	Communication No.	Function	Unit	Minimum setting unit Panel/Communication	Adjustment range	Default setting	User setting	Reference		
<i>R L L</i>	0009	Acceleration time 1	s	0.1/0.1	0.0-3600 (360.0)	10.0		5.4		
<i>d E L</i>	0010	Deceleration time 1	s	0.1/0.1	0.0-3600 (360.0)	10.0				
<i>F H</i>	0011	Maximum frequency	Hz	0.1/0.01	30.0-500.0	80.0		5.9		
<i>U L</i>	0012	Upper limit frequency	Hz	0.1/0.01	0.5- <i>F H</i>	*1		5.10		
<i>L L</i>	0013	Lower limit frequency	Hz	0.1/0.01	0.0- <i>U L</i>	0.0				
<i>u L</i>	0014	Base frequency 1	Hz	0.1/0.01	20.0-500.0	*1				
<i>u L u</i>	0409	Base frequency voltage 1	V	1/0.1	50-330 (240V class) 50-660 (500V class)	*1		5.11 6.15.6		
<i>P E</i>	0015	V/F control mode selection	-	-	0: V/F constant 1: Variable torque 2: Automatic torque boost control 3: Vector control 4: Energy-saving 5: Dynamic energy-saving (For fan and pump) 6: PM motor control 7: V/F 5-point setting 8: -	*1		5.12		
<i>u b</i>	0016	Torque boost value 1	%	0.1/0.1	0.0-30.0	*2		5.13		
<i>t H r</i>	0600	Motor electronic-thermal protection level 1	% (A)	1/1	10-100	100		3.5 5.14 6.24.1		
<i>U L A</i>	0017	Electronic-thermal protection characteristic selection	-	-	Setting	Overload protection	OL stall	0	3.5 5.14	
					0	valid	invalid			
					1	Standard motor	valid			valid
					2		invalid			invalid
					3	VF motor	invalid			valid
					4		valid			invalid
					5	valid	valid			
					6	invalid	invalid			
7	invalid	valid								
<i>S r 1</i>	0018	Preset-speed frequency 1	Hz	0.1/0.01	<i>L L - U L</i>	0.0		3.6 5.15		
<i>S r 2</i>	0019	Preset-speed frequency 2	Hz	0.1/0.01	<i>L L - U L</i>	0.0				
<i>S r 3</i>	0020	Preset-speed frequency 3	Hz	0.1/0.01	<i>L L - U L</i>	0.0				
<i>S r 4</i>	0021	Preset-speed frequency 4	Hz	0.1/0.01	<i>L L - U L</i>	0.0				
<i>S r 5</i>	0022	Preset-speed frequency 5	Hz	0.1/0.01	<i>L L - U L</i>	0.0				
<i>S r 6</i>	0023	Preset-speed frequency 6	Hz	0.1/0.01	<i>L L - U L</i>	0.0				
<i>S r 7</i>	0024	Preset-speed frequency 7	Hz	0.1/0.01	<i>L L - U L</i>	0.0				
<i>F P i d</i>	0025	Process input value of PID control	Hz	0.1/0.01	<i>F 3 6 8 - F 3 6 7</i>	0.0			5.16 6.20	

*1: Default setting values vary depending on the setup menu setting. Refer to section 11.5.

*2: Default setting values vary depending on the capacity. Refer to section 11.4.

Title	Communication No.	Function	Unit	Minimum setting unit Panel/Communication	Adjustment range	Default setting	User setting	Reference
ε y P	0007	Default setting	-	-	0: - 1: 50Hz default setting 2: 60Hz default setting 3: Default setting 1 (Initialization) 4: Trip record clear 5: Cumulative operation time clear 6: Initialization of type information 7: Save user setting parameters 8: Load user setting parameters 9: Cumulative fan operation time record clears 10, 11: - 12: Number of starting clear 13: Default setting 2 (Complete initialization)	0		3.1 4.3 4.3.2 5.17
5 ε ε	0099	Checking the region setting * 5	-	-	0: Start setup menu 1: Japan (read only) 2: North America (read only) 3: Asia (read only) 4: Europe (read only)	*1		3.1 4.4 5.18
P 5 ε ε	0050	Registered parameters display selection	-	-	0: Standard setting mode at power on 1: Easy setting mode at power on 2: Easy setting mode only	0		4.5 5.19
F 1 - -	-	Extended parameter starting at 100	-	-	-	-	-	4.2.2
F 2 - -	-	Extended parameter starting at 200	-	-	-	-	-	
F 3 - -	-	Extended parameter starting at 300	-	-	-	-	-	
F 4 - -	-	Extended parameter starting at 400	-	-	-	-	-	
F 5 - -	-	Extended parameter starting at 500	-	-	-	-	-	
F 6 - -	-	Extended parameter starting at 600	-	-	-	-	-	
F 7 - -	-	Extended parameter starting at 700	-	-	-	-	-	
F 8 - -	-	Extended parameter starting at 800	-	-	-	-	-	
F 9 - -	-	Extended parameter starting at 900	-	-	-	-	-	
Α - - -	-	Extended parameter starting at A	-	-	-	-	-	
Γ - - -	-	Extended parameter starting at C	-	-	-	-	-	
U - U	-	Automatic edit function	-	-	-	-	-	4.3.1 5.20

*1: Default setting values vary depending on the setup menu setting. Refer to section 11.5.

*5: Set "0" to activate the setup menu. Refer to section 11.5 about setting contents selected in setup menu.

11.3 Extended parameters

• Input/output parameters 1

Title	Communication No.	Function	Unit	Minimum setting unit Panel/Communication	Adjustment range	Default setting	User setting	Reference
F 100	0100	Low-speed signal output frequency	Hz	0.1/0.01	0.0- <i>F</i> H	0.0		6.1.1
F 101	0101	Speed reach setting frequency	Hz	0.1/0.01	0.0- <i>F</i> H	0.0		6.1.3
F 102	0102	Speed reach detection band	Hz	0.1/0.01	0.0- <i>F</i> H	2.5		6.1.2 6.1.3
F 104	0104	Always active function selection 1	-	-	0-153 *6	0 (No function)		6.3.1
F 105	0105	Priority selection (Both F and R are ON)	-	-	0: Reverse 1: Deceleration Stop	1		6.2.1
F 107	0107	Analog input terminal selection (VIB)	-	-	0: 0-+10V 1: -10-+10V	0		6.2.2 6.6.2 7.3
F 108	0108	Always active function selection 2	-	-	0-153 *6	0 (No function)		6.3.1
F 109	0109	Analog/logic input selection (VIA/VIB)	-	-	0: Analog input for communications VIB - analog input 1: VIA - analog input VIB - contact input (Sink) 2: VIA - analog input VIB - contact input (Source) 3: VIA - contact input (Sink) VIB - contact input (Sink) 4: VIA - contact input (Source) VIB - contact input (Source)	0		6.2.3 6.3.2 6.6.2 7.2.1 7.3
F 110	0110	Always active function selection 3	-	-	0-153 *6	6 (ST)		6.3.1
F 111	0111	Input terminal selection 1A (F)	-	-	0-203 *6	2 (F)		6.3.2 7.2.1
F 112	0112	Input terminal selection 2A (R)	-	-		4 (R)		
F 113	0113	Input terminal selection 3A (RES)	-	-		8 (RES)		
F 114	0114	Input terminal selection 4A (S1)	-	-		10 (SS1)		
F 115	0115	Input terminal selection 5 (S2)	-	-		12 (SS2)		
F 116	0116	Input terminal selection 6 (S3)	-	-		14 (SS3)		
F 117	0117	Input terminal selection 7 (VIB)	-	-		16 (SS4)		
F 118	0118	Input terminal selection 8 (VIA)	-	-	8-55 *6 24 (AD2)		6.3.2 7.2.1	

*6: Refer to section 11.6 for details about input terminal function.

Title	Communication No.	Function	Unit	Minimum setting unit Panel/Communication	Adjustment range	Default setting	User setting	Reference
F 130	0130	Output terminal selection 1A (RY-RC)	-	-	0-255 *7	4 (LOW)		6.3.3 7.2.2
F 131	0131	Output terminal selection 2A (OUT)	-	-		6 (RCH)		
F 132	0132	Output terminal selection 3 (FL)	-	-		10 (FL)		
F 137	0137	Output terminal selection 1B (RY-RC)	-	-		255 (always ON)		
F 138	0138	Output terminal selection 2B (OUT)	-	-		255 (always ON)		
F 139	0139	Output terminal logic selection (RY-RC, OUT)	-	-	0: F 130 and F 137 F 131 and F 138 1: F 130 or F 137 F 131 and F 138 2: F 130 and F 137 F 131 or F 138 3: F 130 or F 137 F 131 or F 138	0		
F 144	0144	Input terminal response time	ms	1/1	1-1000	1		7.2.1
F 146	0146	Logic input / pulse train input selection (S2)	-	-	0: Logic input 1: Pulse train input	0		6.6.5
F 147	0147	Logic input / PTC input selection (S3)	-	-	0: Logic input 1: PTC input	0		2.3.2 6.24.15
F 151	0151	Input terminal selection 1B (F)	-	-	0-203 *6	0		6.3.2 7.2.1
F 152	0152	Input terminal selection 2B (R)	-	-		0		
F 153	0153	Input terminal selection 3B (RES)	-	-		0		
F 154	0154	Input terminal selection 4B (S1)	-	-		0		
F 155	0155	Input terminal selection 1C (F)	-	-		0		
F 156	0156	Input terminal selection 2C (R)	-	-		0		
F 167	0167	Frequency command agreement detection range	Hz	0.1/0.01	0.0-FH	2.5		6.3.4

*6: Refer to section 11.6 for details about input terminal function.

*7: Refer to section 11.7 for details about output terminal function.

- Basic parameter 2

Title	Communication No.	Function	Unit	Minimum setting unit Panel/Communication	Adjustment range	Default setting	User setting	Reference
F170	0170	Base frequency 2	Hz	0.1/0.01	20.0-500.0	*1		6.4.1
F171	0171	Base frequency voltage 2	V	1/0.1	50-330 (240V class) 50-660 (500V class)	*1		
F172	0172	Torque boost value 2	%	0.1/0.1	0.0-30.0	*2		
F173	0173	Motor electronic-thermal protection level 2	% (A)	1/1	10-100	100		3.5 6.4.1 6.24.1
F185	0185	Stall prevention level 2	% (A)	1/1	10-199, 200 (disabled)	150		6.4.1 6.24.2
F190	0190	V/F 5-point setting VF1 frequency	Hz	0.1/0.01	0.0-FH	0.0		5.12 6.5
F191	0191	V/F 5-point setting VF1 voltage	%	0.1/0.01	0.0-125.0	0.0		
F192	0192	V/F 5-point setting VF2 frequency	Hz	0.1/0.01	0.0-FH	0.0		
F193	0193	V/F 5-point setting VF2 voltage	%	0.1/0.01	0.0-125.0	0.0		
F194	0194	V/F 5-point setting VF3 frequency	Hz	0.1/0.01	0.0-FH	0.0		
F195	0195	V/F 5-point setting VF3 voltage	%	0.1/0.01	0.0-125.0	0.0		
F196	0196	V/F 5-point setting VF4 frequency	Hz	0.1/0.01	0.0-FH	0.0		
F197	0197	V/F 5-point setting VF4 voltage	%	0.1/0.01	0.0-125.0	0.0		
F198	0198	V/F 5-point setting VF5 frequency	Hz	0.1/0.01	0.0-FH	0.0		
F199	0199	V/F 5-point setting VF5 voltage	%	0.1/0.01	0.0-125.0	0.0		

- Frequency parameters

Title	Communication No.	Function	Unit	Minimum setting unit Panel/Communication	Adjustment range	Default setting	User setting	Reference
F200	0200	Frequency priority selection	-	-	0: F $\bar{R}\bar{D}$ (Switchable to F $\bar{2}\bar{D}$ by terminal input) 1: F $\bar{R}\bar{D}$ (Switchable to F $\bar{2}\bar{D}$ at 1.0Hz or less of designated frequency)	0		6.6.1 7.3
F201	0201	VIA input point 1 setting	%	1/1	0-100	0		6.6.2 7.3
F202	0202	VIA input point 1 frequency	Hz	0.1/0.01	0.0-500.0	0.0		
F203	0203	VIA input point 2 setting	%	1/1	0-100	100		
F204	0204	VIA input point 2 frequency	Hz	0.1/0.01	0.0-500.0	*1		
F205	0205	VIA input point 1 rate	%	1/0.01	0-250	0		6.26
F206	0206	VIA input point 2 rate	%	1/0.01	0-250	100		
F207	0207	Frequency setting mode selection 2	-	-	0-11 (Same as F $\bar{R}\bar{D}$)	1		6.3.4 6.6.1 7.3

*1: Default setting values vary depending on the setup menu setting. Refer to section 11.5.

*2: Default setting values vary depending on the capacity. Refer to section 11.4.

Title	Communication No.	Function	Unit	Minimum setting unit Panel/Communication	Adjustment range	Default setting	User setting	Reference
F209	0209	Analog input filter	ms	1/1	2-1000	64		6.6.2 7.3
F210	0210	VIB input point 1 setting	%	1/1	-100-+100	0		
F211	0211	VIB input point 1 frequency	Hz	0.1/0.01	0.0-500.0	0.0		
F212	0212	VIB input point 2 setting	%	1/1	-100-+100	100		
F213	0213	VIB input point 2 frequency	Hz	0.1/0.01	0.0-500.0	*1		
F214	0214	VIB input point 1 rate	%	1/0.01	-250-+250	0		6.26 6.27
F215	0215	VIB input point 2 rate	%	1/0.01	-250-+250	100		
F216	0216	VIC input point 1 setting	%	1/1	0-100	0		6.6.2 7.3
F217	0217	VIC input point 1 frequency	Hz	0.1/0.01	0.0-500.0	0.0		
F218	0218	VIC input point 2 setting	%	1/1	0-100	100		
F219	0219	VIC input point 2 frequency	Hz	0.1/0.01	0.0-500.0	*1		
F220	0220	VIC input point 1 rate	%	1/0.01	0-250	0		
F221	0221	VIC input point 2 rate	%	1/0.01	0-250	100		6.26
F239	0239	Factory specific coefficient 2A	-	-	-	-		* 3
F240	0240	Starting frequency setting	Hz	0.1/0.01	0.1-10.0	0.5		6.7.1
F241	0241	Operation starting frequency	Hz	0.1/0.01	0.0- <i>FH</i>	0.0		6.7.2
F242	0242	Operation starting frequency hysteresis	Hz	0.1/0.01	0.0- <i>FH</i>	0.0		
F249	0249	PWM carrier frequency during DC braking	kHz	0.1/0.1	2.0-16.0	4.0		
F250	0250	DC braking starting frequency	Hz	0.1/0.01	0.0- <i>FH</i>	0.0		6.8.1
F251	0251	DC braking current	%(A)	1/1	0-100	50		
F252	0252	DC braking time	s	0.1/0.1	0.0-25.5	1.0		
F254	0254	Motor shaft fixing control	-	-	0: Disabled 1: Enabled (after DC braking)	0		6.8.2
F256	0256	Time limit for lower-limit frequency operation	s	0.1/0.1	0: Disabled 0.1-600.0	0.0		6.9.1
F257	0257	Factory specific coefficient 2B	-	-	-	-		* 3
F258	0258	Factory specific coefficient 2C	-	-	-	-		* 3

*1: Default setting values vary depending on the setup menu setting. Refer to section 11.5.

*3: Factory specific coefficient parameters are manufacturer setting parameters. Do not change the value of these parameters.

Title	Communication No.	Function	Unit	Minimum setting unit Panel/Communication	Adjustment range	Default setting	User setting	Reference
F260	0260	Jog run frequency	Hz	0.1/0.01	F240-20.0	5.0		6.10
F261	0261	Jog run stopping pattern	-	-	0: Deceleration stop 1: Coast stop 2: DC braking stop	0		
F262	0262	Panel jog run operation mode	-	-	0: Invalid 1: Valid	0		
F264	0264	External logic input - UP response time	s	0.1/0.1	0.0-10.0	0.1		6.6.3
F265	0265	External logic input - UP frequency steps	Hz	0.1/0.01	0.0-FH	0.1		
F266	0266	External logic input - DOWN response time	s	0.1/0.1	0.0-10.0	0.1		
F267	0267	External logic input - DOWN frequency steps	Hz	0.1/0.01	0.0-FH	0.1		
F268	0268	Initial value of UP/DOWN frequency	Hz	0.1/0.01	LL-UL	0.0		
F269	0269	Change of the initial value of UP/DOWN frequency	-	-	0: Not changed 1: Setting of F268 changed when power is turned off	1		
F270	0270	Jump frequency 1	Hz	0.1/0.01	0.0-FH	0.0		
F271	0271	Jumping width 1	Hz	0.1/0.01	0.0-30.0	0.0		
F272	0272	Jump frequency 2	Hz	0.1/0.01	0.0-FH	0.0		
F273	0273	Jumping width 2	Hz	0.1/0.01	0.0-30.0	0.0		
F274	0274	Jump frequency 3	Hz	0.1/0.01	0.0-FH	0.0		
F275	0275	Jumping width 3	Hz	0.1/0.01	0.0-30.0	0.0		
F287	0287	Preset-speed frequency 8	Hz	0.1/0.01	LL-UL	0.0		3.6 6.12
F288	0288	Preset-speed frequency 9	Hz	0.1/0.01	LL-UL	0.0		
F289	0289	Preset-speed frequency 10	Hz	0.1/0.01	LL-UL	0.0		
F290	0290	Preset-speed frequency 11	Hz	0.1/0.01	LL-UL	0.0		
F291	0291	Preset-speed frequency 12	Hz	0.1/0.01	LL-UL	0.0		
F292	0292	Preset-speed frequency 13	Hz	0.1/0.01	LL-UL	0.0		
F293	0293	Preset-speed frequency 14	Hz	0.1/0.01	LL-UL	0.0		
F294	0294	Preset-speed frequency 15	Hz	0.1/0.01	LL-UL	0.0		3.6 6.25
F295	0295	Bumpless operation selection	-	-	0: Disabled 1: Enabled	0		
F298	0298	Factory specific coefficient 2D	-	-	-	-		*3

*3: Factory specific coefficient parameters are manufacturer setting parameters. Do not change the value of these parameters.

• Operation mode parameters

Title	Communication No.	Function	Unit	Minimum setting unit Panel/Communication	Adjustment range	Default setting	User setting	Reference
F300	0300	PWM carrier frequency	kHz	0.1/0.1	2.0 -16.0	4.0		6.14
F301	0301	Auto-restart control selection	-	-	0: Disabled 1: At auto-restart after momentary stop 2: At ST terminal off and on 3: 1+2 4: At start-up	0		6.15.1
F302	0302	Regenerative power ride-through control (Deceleration stop)	-	-	0: Disabled 1: Regenerative power ride-through control 2: Deceleration stop during power failure 3: Synchronized acceleration / deceleration (signal) 4: Synchronized acceleration / deceleration (signal + failure)	0		6.15.2
F303	0303	Retry selection (number of times)	Times	1/1	0: Disabled 1-10	0		6.15.3
F304	0304	Dynamic braking selection	-	-	0: Disabled 1: Enabled, Resistor overload protection enabled 2: Enabled 3: Enabled, Resistor overload protection enabled (At ST terminal on) 4: Enabled (At ST terminal on)	0		6.15.4
F305	0305	Overvoltage limit operation (Deceleration stop mode selection)	-	-	0: Enabled 1: Disabled 2: Enabled (Quick deceleration control) 3: Enabled (Dynamic quick deceleration control)	2		6.15.5
F307	0307	Supply voltage correction (output voltage limitation)	-	-	0: Supply voltage uncorrected, output voltage limited 1: Supply voltage corrected, output voltage limited 2: Supply voltage uncorrected, output voltage unlimited 3: Supply voltage corrected, output voltage unlimited	*1		6.15.6
F308	0308	Dynamic braking resistance	Ω	0.1/0.1	1.0-1000	*2		6.15.4
F309	0309	Allowable continuous braking resistance	kW	0.01/0.01	0.01-30.00	*2		
F310	0310	Factory specific coefficient 3A	-	-	-	-		*3
F311	0311	Reverse-run prohibition	-	-	0: Forward/reverse run permitted 1: Reverse run prohibited 2: Forward run prohibited	0		6.15.7
F312	0312	Random mode	-	-	0: Disabled 1: Random mode 1 2: Random mode 2 3: Random mode 3	0		6.14

*1: Default setting values vary depending on the setup menu setting. Refer to section 11.5.

*2: Default setting values vary depending on the capacity. Refer to section 11.4.

*3: Factory specific coefficient parameters are manufacturer setting parameters. Do not change the value of these parameters.

Title	Communication No.	Function	Unit	Minimum setting unit Panel/Communication	Adjustment range	Default setting	User setting	Reference
F315	0316	Carrier frequency control mode selection	-	-	0: Carrier frequency without reduction 1: Carrier frequency with automatic reduction 2: Carrier frequency not reduced automatically Support for 500V models 3: Carrier frequency reduced automatically Support for 500V models	1		6.14
F317	0317	Synchronized deceleration time (time elapsed between start of deceleration to stop)	s	0.1/0.01	0.0-3600 (360.0)	2.0		6.15.2
F318	0318	Synchronized acceleration time (time elapsed between start of acceleration to achievement of specified speed)	s	0.1/0.01	0.0-3600 (360.0)	2.0		
F319	0319	Regenerative over-excitation upper limit	%	1/1	100-160	120		6.15.5
F320	0320	Droop gain	%	0.1/0.1	0.0-100.0	0.0		6.16
F323	0323	Droop insensitive torque band	%	1/1	0-100	10		
F324	0324	Droop output filter	-	0.1/0.1	0.1-200.0	100.0		
F328	0328	Light-load high-speed operation selection	-	-	0:Disabled 1:High-speed operation speed set automatically (Power running at F command: Increase) 2:High-speed operation speed set automatically (Power running at R command: Increase) 3:High-speed operation speed set with F330 (Power running at F command: Increase) 4:High-speed operation speed set with F330 (Power running at R command: Increase)	0		6.17
F329	0329	Light-load high-speed learning function	-	-	0:No learning 1:Forward run learning 2:Reverse run learning	0		
F330	0330	Automatic light-load high-speed operation frequency	Hz	0.1/0.01	30.0- \bar{U} L	*1		
F331	0331	Light-load high-speed operation switching lower limit frequency	Hz	0.1/0.01	5.0- \bar{U} L	40.0		
F332	0332	Light-load high-speed operation load waiting time	s	0.1/0.1	0.0-10.0	0.5		
F333	0333	Light-load high-speed operation load detection time	s	0.1/0.1	0.0-10.0	1.0		

*1: Default setting values vary depending on the setup menu setting. Refer to section 11.5.

Title	Communication No.	Function	Unit	Minimum setting unit Panel/Communication	Adjustment range	Default setting	User setting	Reference
F334	0334	Light-load high-speed operation heavy load detection time	s	0.1/0.1	0.0-10.0	0.5		6.17
F335	0335	Switching load torque during power running	%	1/0.01	-250- +250	50		
F336	0336	Heavy-load torque during power running	%	1/0.01	-250- +250	100		
F337	0337	Heavy-load torque during constant power running	%	1/0.01	-250- +250	50		
F338	0338	Switching load torque during regenerative braking	%	1/0.01	-250- +250	50		
F340	0340	Creeping time 1	s	0.01/0.01	0.00-10.00	0.00		6.18.1
F341	0341	Braking mode selection	-	-	0: Disabled 1: Forward winding up 2: Reverse winding up 3: Horizontal operation	0		
F342	0342	Load portion torque input selection	-	-	0: Disabled 1: VIA 2: VIB 3: VIC 4: F343	0		
F343	0343	Hoisting torque bias input (valid only when F342=4)	%	1/0.01	-250- +250	100		
F344	0344	Lowering torque bias multiplier	%	1/0.01	0-100	100		
F345	0345	Brake release time	s	0.01/0.01	0.00-10.00	0.05		
F346	0346	Creeping frequency	Hz	0.1/0.01	F240 -20.0	3.0		
F347	0347	Creeping time 2	s	0.01/0.01	0.00-10.00	0.10		
F348	0348	Braking time learning function	-	1/1	0:Disabled 1: Learning (0 after adjustment)	0		
F349	0349	Acceleration/deceleration suspend function	-	1/1	0:Disabled 1:Parameter setting 2:Terminal input	0		6.19
F350	0350	Acceleration suspend frequency	Hz	0.1/0.01	0.0-FH	0.0		
F351	0351	Acceleration suspend time	s	0.1/0.1	0.0-10.0	0.0		
F352	0352	Deceleration suspend frequency	Hz	0.1/0.01	0.0-FH	0.0		
F353	0353	Deceleration suspend time	s	0.1/0.1	0.0-10.0	0.0		
F359	0359	PID control waiting time	s	1/1	0-2400	0		6.20
F360	0360	PID control	-	-	0: Disabled 1: Process type PID control 2: Speed type PID control	0		
F361	0361	Delay filter	s	0.1/0.1	0.0-25.0	0.1		
F362	0362	Proportional gain	-	0.01/0.01	0.01-100.0	0.30		

Title	Communication No.	Function	Unit	Minimum setting unit Panel/Communication	Adjustment range	Default setting	User setting	Reference
F 3 6 3	0363	Integral gain	-	0.01/0.01	0.01-100.0	0.20		6.20
F 3 6 6	0366	Differential gain	-	0.01/0.01	0.00-2.55	0.00		
F 3 6 7	0367	Process upper limit	Hz	0.1/0.01	0.0-F H	*1		
F 3 6 8	0368	Process lower limit	Hz	0.1/0.01	0.0-F 3 6 7	0.0		
F 3 6 9	0369	PID control feedback signal selection	-	-	0: Disabled 1: VIA 2: VIB 3: VIC 4 to 6: -	0		
F 3 7 2	0372	Process increasing rate (speed type PID control)	s	0.1/0.1	0.1-600.0	10.0		6.6.5
F 3 7 3	0373	Process decreasing rate (speed type PID control)	s	0.1/0.1	0.1-600.0	10.0		
F 3 7 5	0375	Factory specific coefficient 3B	-	-	-	-	* 3	
F 3 7 6	0376	Factory specific coefficient 3C	-	-	-	-	-	6.20
F 3 7 8	0378	Number of pulse train input	pps	1/1	100-5000	250		
F 3 8 0	0380	PID forward/reverse characteristics selection	-	-	0: Forward 1: Reverse	0		
F 3 8 2	0382	Hit and stop control	-	-	0: Disabled 1: Enabled 2: -	0		
F 3 8 3	0383	Hit and stop control frequency	Hz	0.1/0.01	0.1-30.0	5.0		6.18.2
F 3 8 4	0384	Factory specific coefficient 3D	-	-	-	-	* 3	
F 3 8 5	0385	Factory specific coefficient 3E	-	-	-	-	-	
F 3 8 6	0386	Factory specific coefficient 3F	-	-	-	-	-	
F 3 8 9	0389	PID control reference signal selection	-	-	0: F R B d I F 2 0 7 selected 1: Terminal board VIA 2: Terminal board VIB 3: F P I d 4: RS485 communication 5: UP/DOWN from external logic input 6: CANopen communication 7: Communication option 8: Terminal board VIC 9, 10: - 11: Pulse train input	0		6.20
F 3 9 0	0390	Factory specific coefficient 3G	-	-	-	-	-	* 3
F 3 9 1	0391	Hysteresis for lower-limit frequency operation	Hz	0.1/0.01	0.0-UL	0.2		6.9.1

*1: Default setting values vary depending on the setup menu setting. Refer to section 11.5.

*3: Factory specific coefficient parameters are manufacturer setting parameters. Do not change the value of these parameters.

• Torque boost parameters 1

Title	Communication No.	Function	Unit	Minimum setting unit Panel/Communication	Adjustment range	Default setting	User setting	Reference
F400	0400	Auto-tuning	-	-	0: Auto-tuning disabled 1: Initialization of F402 (after execution: 0) 2: Auto-tuning executed (after execution: 0) 3: 4: Motor constant auto calculation (after execution: 0) 5: 4*2 (after execution: 0)	0		6.21
F401	0401	Slip frequency gain	%	1/1	0-150	50		
F402	0402	Automatic torque boost value	%	0.1/0.1	0.1-30.0	*2		
F405	0405	Motor rated capacity	kW	0.01/0.01	0.01-22.00	*2		
F412	0412	Motor specific coefficient 1	-	-	-	-		*4
F415	0415	Motor rated current	A	0.1/0.1	0.1-100.0	*2		6.21
F416	0416	Motor no-load current	%	1/1	10-90	*2		
F417	0417	Motor rated speed	min-1	1/1	100-64000	*1		
F441	0441	Power running torque limit 1 level	%	1/0.01	0-249%, 250:Disabled	250		6.22.1
F443	0443	Regenerative braking torque limit 1 level	%	1/0.01	0-249%, 250:Disabled	250		
F444	0444	Power running torque limit 2 level	%	1/0.01	0-249%, 250:Disabled	250		
F445	0445	Regenerative braking torque limit 2 level	%	1/0.01	0-249%, 250:Disabled	250		
F451	0451	Acceleration/deceleration operation after torque limit	-	1/1	0: In sync with acceleration / deceleration 1: In sync with min. time	0		6.22.2
F452	0452	Power running stall continuous trip detection time	s	0.01/0.01	0.00-10.00	0.00		6.22.3
F454	0454	Constant output zone torque limit selection	-	-	0:Constant output limit 1:Constant torque limit	0		6.22.1
F458	0458	Motor specific coefficient 2	-	-	-	-		*4
F459	0459	Load inertia moment ratio	Times	0.1/0.1	0.1-100.0	1.0		6.21
F460	0460	Motor specific coefficient 3	-	-	-	-		*4
F461	0461	Motor specific coefficient 4	-	-	-	-		
F462	0462	Motor specific coefficient 5	-	-	-	-		
F467	0467	Motor specific coefficient 6	-	-	-	-		

*1: Default setting values vary depending on the setup menu setting. Refer to section 11.5.

*2: Default setting values vary depending on the capacity. Refer to section 11.4.

*4: Motor specific coefficient parameters are manufacturer setting parameters. Do not change the value of these parameters.

- Input/output parameters 2

Title	Communication No.	Function	Unit	Minimum setting unit Panel/Communication	Adjustment range	Default setting	User setting	Reference
F470	0470	VIA input bias	-	1/1	0-255	128		6.6.4
F471	0471	VIA input gain	-	1/1	0-255	128		
F472	0472	VIB input bias	-	1/1	0-255	128		
F473	0473	VIB input gain	-	1/1	0-255	128		
F474	0474	VIC input bias	-	1/1	0-255	128		
F475	0475	VIC input gain	-	1/1	0-255	128		

- Torque boost parameters 2

Title	Communications No.	Function	Unit	Minimum setting unit Panel/Communications	Adjustment range	Default setting	User setting	Reference
F480	0480	Motor specific coefficient 7	-	-	-	-		* 4
F485	0485	Motor specific coefficient 8	-	-	-	-		
F490	0490	Motor specific coefficient 9	-	-	-	-		
F495	0495	Motor specific coefficient 10	-	-	-	-		
F499	0499	Motor specific coefficient 11	-	-	-	-		

*4: Motor specific coefficient parameters are manufacturer setting parameters. Do not change the value of these parameters.

- Acceleration/deceleration time parameters

Title	Communication No.	Function	Unit	Minimum setting unit Panel/Communication	Adjustment range	Default setting	User setting	Reference
F500	0500	Acceleration time 2	s	0.1/0.1	0.0-3600 (360.0)	10.0		6.23.2
F501	0501	Deceleration time 2	s	0.1/0.1	0.0-3600 (360.0)	10.0		
F502	0502	Acceleration/deceleration 1 pattern	-	-	0: Linear 1: S-pattern 1	0		6.23.1
F503	0503	Acceleration/deceleration 2 pattern	-	-	2: S-pattern 2	0		6.23.2
F504	0504	Acceleration/deceleration selection (1, 2, 3)	-	-	1: Acceleration/deceleration 1 2: Acceleration/deceleration 2 3: Acceleration/deceleration 3	1		6.23.1
F505	0505	Acceleration/deceleration 1 and 2 switching frequency	Hz	0.1/0.01	0.0 (disabled) 0.1-111	0.0		
F506	0506	S-pattern lower-limit adjustment amount	%	1/1	0-50	10		
F507	0507	S-pattern upper-limit adjustment amount	%	1/1	0-50	10		
F510	0510	Acceleration time 3	s	0.1/0.01	0.0-3600 (360.0)	10.0		

Title	Communication No.	Function	Unit	Minimum setting unit Panel/Communication	Adjustment range	Default setting	User setting	Reference
F511	0511	Deceleration time 3	s	0.1/0.01	0.0-3600 (360.0)	10.0		6.23.2
F512	0512	Acceleration/deceleration 3 pattern	-	-	0: Linear 1: S-pattern 1 2: S-pattern 2	0		
F513	0513	Acceleration/deceleration 2 and 3 switching frequency	Hz	0.1/0.01	0.0 (disabled) 0.1-UL	0.0		
F515	0515	Deceleration time at emergency stop	s	0.1/0.01	0.0-3600 (360.0)	10.0		6.24.4
F519	0519	Setting of acceleration/deceleration time unit	-	-	0: - 1: 0.01s unit (after execution: 0) 2: 0.1s unit (after execution: 0)	0		6.23.2

• Protection parameters

Title	Communication No.	Function	Unit	Minimum setting unit Panel/Communication	Adjustment range	Default setting	User setting	Reference
F601	0601	Stall prevention level 1	% (A)	1/1	10-199, 200 (disabled)	150		6.24.2
F602	0602	Inverter trip retention selection	-	-	0: Cleared with power off 1: Retained with power off	0		6.24.3
F603	0603	Emergency stop selection	-	-	0: Coast stop 1: Deceleration stop 2: Emergency DC braking 3: Deceleration stop (F515) 4: Quick deceleration stop 5: Dynamic quick deceleration stop	0		6.24.4
F604	0604	DC braking time during emergency stop	s	0.1/0.1	0.0-20.0	1.0		
F605	0605	Output phase failure detection selection	-	-	0: Disabled 1: At start-up (only one time after power on) 2: At start-up (each time) 3: During operation 4: At start-up + during operation 5: Detection of cutoff on output side	0		6.24.5
F607	0607	Motor 150% overload detection time	s	1/1	10-2400	300		3.5 6.24.1
F608	0608	Input phase failure detection selection	-	-	0: Disabled 1: Enabled	1		6.24.6
F609	0609	Small current detection hysteresis	%	1/1	1-20	10		6.24.7
F610	0610	Small current trip/alarm selection	-	-	0: Alarm only 1: Tripping	0		
F611	0611	Small current detection current	% (A)	1/1	0-150	0		
F612	0612	Small current detection time	s	1/1	0-255	0		
F613	0613	Detection of output short-circuit at start-up	-	-	0: Each time (standard pulse) 1: Only one time after power on (standard pulse) 2: Each time (short pulse) 3: Only one time after power on (short pulse)	0		6.24.8

Title	Communication No.	Function	Unit	Minimum setting unit Panel/Communication	Adjustment range	Default setting	User setting	Reference
F 6 15	0615	Over-torque trip/alarm selection	-	-	0: Alarm only 1: Tripping	0		6.24.9
F 6 16	0616	Over-torque detection level	%	1/0.01	0 (disabled) 1-250	150		
F 6 18	0618	Over-torque detection time	s	0.1/0.1	0.0-10.0	0.5		
F 6 19	0619	Over-torque detection hysteresis	%	1/1	0-100	10		
F 6 20	0620	Cooling fan ON/OFF control	-	-	0: ON/OFF control 1: Always ON	0		6.24.10
F 6 21	0621	Cumulative operation time alarm setting	100 hours	0.1/0.1 (=10 hours)	0.0-999.0	876.0		6.24.11
F 6 26	0626	Over-voltage stall protection level	%	1/1	100-150	*2		6.15.4 6.15.5
F 6 27	0627	Undervoltage trip/alarm selection	-	-	0: Alarm only 1: Tripping 2: -	0		6.24.12
F 6 31	0631	Inverter overload detection method	-	-	0: 150%-60s (120%-60s) 1: Temperature estimation	0		3.5
F 6 32	0632	Electronic-thermal memory	-	-	0: Disabled 1: Enabled	0		3.5 6.24.1
F 6 33	0633	Analog input break detection level (VIC)	%	1/1	0: Disabled, 1-100	0		6.24.13
F 6 34	0634	Annual average ambient temperature (parts replacement alarms)	-	-	1: -10 to +10°C 2: 11-20°C 3: 21-30°C 4: 31-40°C 5: 41-50°C 6: 51-60°C	3		6.24.14
F 6 44	0644	Operation selection of analog input break detection (VIC)	-	-	0: Tripping 1: Alarm only (Coast stop) 2: Alarm only (F 6 49 frequency) 3: Alarm only (Maintain running) 4: Alarm only (Deceleration stop)	0		6.24.13
F 6 45	0645	PTC thermal selection	-	-	1: Tripping 2: Alarm only	1		6.24.15
F 6 46	0646	PTC detection resistor value	Ω	1/1	100-9999	3000		
F 6 48	0648	Number of starting alarm	10000 times	0.1/0.1	0.0-999.0	999.0		6.24.16
F 6 49	0649	Fallback frequency	Hz	0.1/0.01	L L - U L	0.0		6.24.13
F 6 50	0650	Forced fire-speed control selection	-	-	0: Disabled 1: Enabled	0		6.25
F 6 56	0656	Factory specific coefficient 6A	-	-	-	-		*3
F 6 57	0657	Overload alarm level	%	1/1	10-100	50		3.5
F 6 60	0660	Override addition input selection	-	-	0: Disabled 1: VIA 2: VIB 3: VIC 4: F C	0		6.26

*2: Default setting values vary depending on the capacity. Refer to section 11.4.

*3: Factory specific coefficient parameters are manufacturer setting parameters. Do not change the value of these parameters.

Title	Communication No.	Function	Unit	Minimum setting unit Panel/Communication	Adjustment range	Default setting	User setting	Reference
F 6 6 1	0661	Override multiplication input selection	-	-	0: Disabled 1: VIA 2: VIB 3: VIC 4: F 7 2 9	0		6.26
F 6 6 3	0663	Analog input terminal function selection (VIB)	-	-	0: Frequency command 1: Acceleration/deceleration time 2: Upper limit frequency 3, 4: - 5: Torque boost value 6: Stall prevention level 7: Motor electronic-thermal protection level 8 to 10: - 11: Base frequency	0		6.27

• Output parameters

Title	Communication No.	Function	Unit	Minimum setting unit Panel/Communication	Adjustment range	Default setting	User setting	Reference
F 6 6 9	0669	Logic output/pulse train output selection (OUT)	-	-	0: Logic output 1: Pulse train output	0		6.28.1
F 6 7 6	0676	Pulse train output function selection (OUT)	-	-	0: Output frequency 1: Output current 2: Frequency reference 3: Input voltage (DC detection) 4: Output voltage (command value) 5: Input power 6: Output power 7: Torque 8: - 9: Motor cumulative load factor 10: Inverter cumulative load factor 11: PBR (Braking resistor) cumulative load factor 12: Frequency setting value (after compensation) 13: VIA input value 14: VIB input value 15: Fixed output 1 (output current 100% equivalent) 16: Fixed output 2 (output current 50% equivalent) 17: Fixed output 3 (Other than the output current) 18: Communication data 19: - 20: VIC input value 21, 22: - 23: PID feedback value	0		
F 6 7 7	0677	Maximum numbers of pulse train output	kpps	0.01/0.01	0.50-2.00	0.80		
F 6 7 8	0678	Pulse train output filter	ms	1/1	2-1000	64		
F 6 7 9	0679	Pulse train input filter	ms	1/1	2-1000	2		

Title	Communication No.	Function	Unit	Minimum setting unit Panel/Communication	Adjustment range	Default setting	User setting	Reference
F681	0681	Analog output signal selection	-	-	0: Meter option (0 to 1 mA) 1: Current (0 to 20 mA) output 2: Voltage (0 to 10 V) output	0		3.4 6.28.2
F684	0684	Analog output filter	ms	1/1	2-1000	2		
F691	0691	Inclination characteristic of analog output	-	-	0: Negative inclination (downward slope) 1: Positive inclination (upward slope)	1		
F692	0692	Analog output bias	%	0.1/0.1	-1.0—+100.0	0.0		
F693	0693	Factory specific coefficient 6B	-	-	-	-		* 3

*3: Factory specific coefficient parameters are manufacturer setting parameters. Do not change the value of these parameters.

• Operation panel parameters

Title	Communication No.	Function	Unit	Minimum setting unit Panel/Communication	Adjustment range	Default setting	User setting	Reference
F700	0700	Parameter protection selection	-	-	0: Permitted 1: Writing prohibited (Panel and remote keypad) 2: Writing prohibited (1 + RS485 communication) 3: Reading prohibited (Panel and remote keypad) 4: Reading prohibited (3 + RS485 communication)	0		6.29.1 6.29.4 6.29.7
F701	0701	Current/voltage unit selection	-	-	0: % 1: A (ampere)/V (volt)	0		
F702	0702	Frequency free unit display magnification	Times	0.01/0.01	0.00: Disabled (display of frequency) 0.01-200.0	0.00		
F703	0703	Frequency free unit coverage selection	-	1/1	0: All frequencies display 1: PID frequencies display	0		
F705	0705	Inclination characteristic of free unit display	-	1/1	0: Negative inclination (downward slope) 1: Positive inclination (upward slope)	1		
F706	0706	Free unit display bias	Hz	0.1/0.01	0.00- <i>F H</i>	0.00		
F707	0707	Free step 1 (1-step rotation of setting dial)	Hz	0.01/0.01	0.00: Disabled 0.01- <i>F H</i>	0.00		
F708	0708	Free step 2 (panel display)	-	-	0: Disabled 1-255	0		
F709	0709	Standard monitor hold function	-	-	0: Real time 1: Peak hold 2: Minimum hold	0		

Title	Communication No.	Function	Unit	Minimum setting unit Panel/Communication	Adjustment range	Default setting	User setting	Reference
F 7 18	0710	Initial panel display selection	-	-	0: Operation frequency (Hz/free unit) 1: Output current (%/A) 2: Frequency setting value (Hz/free unit) 3: Input voltage (DC detection) (%/V) 4: Output voltage (command value) (%/V) 5: Input power (kW) 6: Output power (kW) 7: Torque (%) 8: - 9: Motor cumulative load factor 10: Inverter cumulative load factor 11: PBR (Braking resistor) cumulative load factor 12: Frequency setting value (after compensation) (Hz/free unit) 13: VIA input value (%) 14: VIB input value (%) 15 to 17: - 18: Arbitrary code from communication 19: - 20: VIC input value (%) 21: Pulse train input value (kpps) 22: - 23: PID feedback value (Hz/free unit) 24: Input power (kWh) 25: Output power (kWh) 26: Motor load factor (%) 27: Inverter load factor (%) 28: Inverter rated current (A) 29: FM output value (%) 30: Pulse train output value (kpps) 31: Cumulative power on time (100 hours) 32: Cumulative fan operation time (100 hours) 33: Cumulative operation time (100 hours) 34: Number of starting (10000 times) 35: Forward number of starting (10000 times) 36: Reverse number of starting (10000 times) 37 to 39: - 40: Inverter rated current (Carrier frequency corrected) 41 to 51: -	0		6.29.5 8.2.1 8.3.2

Title	Communication No.	Function	Unit	Minimum setting unit Panel/Communication	Adjustment range	Default setting	User setting	Reference
F 7 1 1	0711	Status monitor 1	-	-	0: Operation frequency (Hz/free unit) 1: Output current (%A) 2: Frequency setting value (Hz/free unit) 3: Input voltage (DC detection) (%V) 4: Output voltage (command value) (%V) 5: Input power (kW) 6: Output power (kW) 7: Torque (%) 8: - 9: Motor cumulative load factor 10: Inverter cumulative load factor	2		6.29.6 8.2.1 8.3.2
F 7 1 2	0712	Status monitor 2	-	-	11: PBR (Braking resistor) cumulative load factor 12: Frequency setting value (after compensation) (Hz/free unit) 13: VIA input value (%) 14: VIB input value (%) 15 to 19: - 20: VIC input value (%) 21: Pulse train input value (kpps) 22: - 23: PID feedback value (Hz/free unit) 24: Input power (kWh) 25: Output power (kWh) 26: Motor load factor (%) 27: Inverter load factor (%) 28: Inverter rated current (A) 29: FM output value (%)	1		
F 7 1 3	0713	Status monitor 3	-	-	30: Pulse train output value (kpps) 31: Cumulative power on time (100 hours) 32: Cumulative fan operation time (100 hours) 33: Cumulative operation time (100 hours) 34: Number of starting (10000 times) 35: Forward number of starting (10000 times) 36: Reverse number of starting (10000 times) 37 to 39: - 40: Inverter rated current (Carrier frequency corrected) 41 to 51: -	3		
F 7 1 4	0714	Status monitor 4	-	-		4		
F 7 1 5	0715	Status monitor 5	-	-		5		
F 7 1 6	0716	Status monitor 6	-	-		6		
F 7 1 7	0717	Status monitor 7	-	-		27		
F 7 1 8	0718	Status monitor 8	-	-		0		
F 7 1 9	0719	Canceling of operation command when standby terminal (ST) is turned off	-	-	0: Operation command canceled (cleared) 1: Operation command retained	1		6.29.8
F 7 2 0	0720	Initial remote keypad display selection	-	-	0-51 (Same as F 7 1 0)	0		6.29.5 8.3.2
F 7 2 1	0721	Panel stop pattern	-	-	0: Deceleration stop 1: Coast stop	0		6.29.9
F 7 2 9	0729	Operation panel override multiplication gain	%	1/1	-100-+100	0		6.26

Title	Communication No.	Function	Unit	Minimum setting unit Panel/Communication	Adjustment range	Default setting	User setting	Reference	
F 730	0730	Panel frequency setting prohibition (F F)	-	-	0: Permitted 1: Prohibited	0		6.29.1	
F 731	0731	Disconnection detection of remote keypad	-	-	0: Permitted 1: Prohibited	0			
F 732	0732	Local/remote key prohibition of remote keypad	-	-	0: Permitted 1: Prohibited	1		6.13 6.29.1	
F 733	0733	Panel operation prohibition (RUN key)	-	-	0: Permitted 1: Prohibited	0		6.29.1	
F 734	0734	Panel emergency stop operation prohibition	-	-	0: Permitted 1: Prohibited	0			
F 735	0735	Panel reset operation prohibition	-	-	0: Permitted 1: Prohibited	0			
F 736	0736	FRSD / FRSD change prohibition during operation	-	-	0: Permitted 1: Prohibited	1			
F 737	0737	All key operation prohibition	-	-	0: Permitted 1: Prohibited	0			
F 738	0738	Password setting (F 700)	-	-	0: Password unset 1-9998 9999: Password set				
F 739	0739	Password verification	-	-	0: Password unset 1-9998 9999: Password set	0			
F 740	0740	Trace selection	-	-	0: Disabled 1: At tripping 2: At triggering 3: 1+2	1			6.30
F 741	0741	Trace cycle	-	-	0: 4ms 1: 20ms 2: 100ms 3: 1s 4: 10s	2			
F 742	0742	Trace data 1	-	-	0-42	0			
F 743	0743	Trace data 2	-	-		1			
F 744	0744	Trace data 3	-	-		2			
F 745	0745	Trace data 4	-	-		3			
F 746	0746	Status monitor filter	ms	-	8-1000	200		6.29.7	
F 748	0748	Integrating wattmeter retention selection	-	-	0: Disabled 1: Enabled	0		6.31	
F 749	0749	Integrating wattmeter display unit selection	-	-	0:1=kWh 1:1=10kWh 2:1=100kWh 3:1=1000kWh	*2			

*2: Default setting values vary depending on the capacity. Refer to section 11.4.

Title	Communication No.	Function	Unit	Minimum setting unit Panel/Communication	Adjustment range	Default setting	User setting	Reference
F 750	0750	EASY key function selection	-	-	0: Easy / standard setting mode switching function 1: Shortcut key 2: Local / remote key 3: Monitor peak / minimum hold trigger	0		6.32
F 751	0751	Easy setting mode parameter 1	-	-	0-2999 (Set by communication number)	3		4.5 6.32
F 752	0752	Easy setting mode parameter 2	-	-		4		
F 753	0753	Easy setting mode parameter 3	-	-		9		
F 754	0754	Easy setting mode parameter 4	-	-		10		
F 755	0755	Easy setting mode parameter 5	-	-		600		
F 756	0756	Easy setting mode parameter 6	-	-		6		
F 757	0757	Easy setting mode parameter 7	-	-		999		
F 758	0758	Easy setting mode parameter 8	-	-		999		
F 759	0759	Easy setting mode parameter 9	-	-		999		
F 760	0760	Easy setting mode parameter 10	-	-		999		
F 761	0761	Easy setting mode parameter 11	-	-		999		
F 762	0762	Easy setting mode parameter 12	-	-		999		
F 763	0763	Easy setting mode parameter 13	-	-		999		
F 764	0764	Easy setting mode parameter 14	-	-		999		
F 765	0765	Easy setting mode parameter 15	-	-		999		
F 766	0766	Easy setting mode parameter 16	-	-		999		
F 767	0767	Easy setting mode parameter 17	-	-		999		
F 768	0768	Easy setting mode parameter 18	-	-		999		
F 769	0769	Easy setting mode parameter 19	-	-		999		
F 770	0770	Easy setting mode parameter 20	-	-		999		
F 771	0771	Easy setting mode parameter 21	-	-		999		
F 772	0772	Easy setting mode parameter 22	-	-		999		
F 773	0773	Easy setting mode parameter 23	-	-		999		
F 774	0774	Easy setting mode parameter 24	-	-		999		
F 775	0775	Easy setting mode parameter 25	-	-		999		
F 776	0776	Easy setting mode parameter 26	-	-		999		
F 777	0777	Easy setting mode parameter 27	-	-		999		

Title	Communication No.	Function	Unit	Minimum setting unit Panel/Communication	Adjustment range	Default setting	User setting	Reference
F778	0778	Easy setting mode parameter 28	-	-	0-2999 (Set by communication number)	999		4.5 6.32
F779	0779	Easy setting mode parameter 29	-	-		999		
F780	0780	Easy setting mode parameter 30	-	-		999		
F781	0781	Easy setting mode parameter 31	-	-		999		
F782	0782	Easy setting mode parameter 32	-	-		50		
F799	0799	Factory specific coefficient 7A	-	-	-	-		*3

*3: Factory specific coefficient parameters are manufacturer setting parameters. Do not change the value of these parameters.

• Communication parameters

Title	Communication No.	Function	Unit	Minimum setting unit Panel/Communication	Adjustment range	Default setting	User setting	Reference
F800	0800	Baud rate	-	-	3: 9600bps 4: 19200bps 5: 38400bps	4		6.33.1
F801	0801	Parity	-	-	0: NON (No parity) 1: EVEN (Even parity) 2: ODD (Odd parity)	1		
F802	0802	Inverter number	-	1/1	0-247	0		
F803	0803	Communication time-out time	s	0.1/0.1	0.0: Disabled, 0.1-100.0	0.0		
F804	0804	Communication time-out action	-	-	0: Alarm only 1: Trip (Coast stop) 2: Trip (Deceleration stop)	0		
F805	0805	Communication waiting time	s	0.01/0.01	0.00-2.00	0.00		
F806	0806	Setting of master and slave for communication between inverters	-	-	0: Slave (0 Hz command issued in case the master inverter fails) 1: Slave (Operation continued in case the master inverter fails) 2: Slave (Emergency stop tripping in case the master inverter fails) 3: Master (transmission of frequency commands) 4: Master (transmission of output frequency signals)	0		
F808	0808	Communication time-out detection condition	-	-	0: Valid at any time 1: Communication selection of F800 or C800 2: 1+ during operation	1		

Title	Communication No.	Function	Unit	Minimum setting unit Panel/Communication	Adjustment range	Default setting	User setting	Reference
F810	0810	Communication command point selection	-	1/1	0: Disabled 1: Enabled	0		6.6.2 6.33.1
F811	0811	Communication command point 1 setting	%	1/1	0-100	0		
F812	0812	Communication command point 1 frequency	Hz	0.1/0.01	0.0-FH	0.0		
F813	0813	Communication command point 2 setting	%	1/1	0-100	100		
F814	0814	Communication command point 2 frequency	Hz	0.1/0.01	0.0-FH	*1		
F829	0829	Selection of communication protocol	-	-	0: Toshiba inverter protocol 1: Modbus RTU protocol	0		6.33.1
F856	0856	Number of motor poles for communication	-	-	1: 2 poles 2: 4 poles 3: 6 poles 4: 8 poles 5: 10 poles 6: 12 poles 7: 14 poles 8: 16 poles	2		
F870	0870	Block write data 1	-	-	0: No selection 1: Command information 1 2: Command information 2	0		
F871	0871	Block write data 2	-	-	3: Frequency setting 4: Output data on the terminal board 5: Analog output for communication 6: Speed command	0		
F875	0875	Block read data 1	-	-	0: No selection 1: Status information 2: Output frequency	0		
F876	0876	Block read data 2	-	-	3: Output current 4: Output voltage	0		
F877	0877	Block read data 3	-	-	5: Alarm information 6: PID feedback value 7: Input terminal board monitor	0		
F878	0878	Block read data 4	-	-	8: Output terminal board monitor 9: VIA terminal board monitor 10: VIB terminal board monitor 11: VIC terminal board monitor	0		
F879	0879	Block read data 5	-	-	12: Input voltage (DC detection) 13: Motor speed 14: Torque	0		
F880	0880	Free notes	-	1/1	0-65530 (65535)	0		
F898	0898	Factory specific coefficient 8A	-	-	-	-		*3
F899	0899	Communication function reset	-	-	0: - 1: Reset (after execution: 0)	0		6.33.1

*1: Default setting values vary depending on the setup menu setting. Refer to section 11.5.

*3: Factory specific coefficient parameters are manufacturer setting parameters. Do not change the value of these parameters.

• PM motor parameters

Title	Communication No.	Function	Unit	Minimum setting unit Panel/Communication	Adjustment range	Default setting	User setting	Reference
F900	0900	Factory specific coefficient 9A	-	-	-	-	-	*3
F901	0901	Factory specific coefficient 9B	-	-	-	-	-	
F902	0902	Factory specific coefficient 9C	-	-	-	-	-	
F909	0909	Factory specific coefficient 9D	-	-	-	-	-	
F910	0910	Step-out detection current level	%	1/1	1-150	100	-	6.34
F911	0911	Step-out detection time	s	0.01/0.01	0.00: No detection 0.01-2.55	0.00	-	
F912	0912	q-axis inductance	mH	0.01/0.01	0.01-650.0	10.00	-	6.21.2 6.34
F913	0913	d-axis inductance	mH	0.01/0.01	0.01-650.0	10.00	-	
F914	0914	Factory specific coefficient 9E	-	-	-	-	-	*3
F915	0915	PM control mode selection	-	-	0: Mode 0 1: Mode 1 2: Mode 2 3: Mode 3 4: Mode 4	3	-	6.21.2
F916	0916	Factory specific coefficient 9F	-	-	-	-	-	*3
F917	0917	Factory specific coefficient 9G	-	-	-	-	-	
F918	0918	Factory specific coefficient 9H	-	-	-	-	-	
F919	0919	Factory specific coefficient 9I	-	-	-	-	-	
F920	0920	Factory specific coefficient 9J	-	-	-	-	-	
F930	0930	Factory specific coefficient 9K	-	-	-	-	-	

*3: Factory specific coefficient parameters are manufacturer setting parameters. Do not change the value of these parameters.

• Traverse parameters

Title	Communication No.	Function	Unit	Minimum setting unit Panel/Communication	Adjustment range	Default setting	User setting	Reference
F980	0980	Traverse selection	-	1/1	0: Disabled 1: Enabled	0	-	6.35
F981	0981	Traverse acceleration time	s	0.1/0.1	0.1-120.0	25.0	-	
F982	0982	Traverse deceleration time	s	0.1/0.1	0.1-120.0	25.0	-	
F983	0983	Traverse step	%	0.1/0.1	0.0-25.0	10.0	-	
F984	0984	Traverse jump step	%	0.1/0.1	0.0-50.0	10.0	-	

• Logic sequence parameters

Title	Communication No.	Function	Unit	Minimum setting unit Panel/Communication	Adjustment range	Default setting	User setting	Reference
A900	A900	Input function target 11	-	-	Input terminal function number 0: No function 1: Terminal F 2: Terminal R 3: Terminal RES 4: Terminal S1 5: Terminal S2 6: Terminal S3 7: Terminal VIB 8: Terminal VIA 9 to 20: - 21 to 24: Virtual input terminal 1 to 4 25 to 32: Internal terminal 1 to 8 918 to 934: Logic sequence function number 1000 to 1255: Output selection number 2000 to 2099: FD00 to FD99 3000 to 3099: FE00 to FE99	0		6.36
A901	A901	Input function command 12	-	-	0:NOP (not operation) 1:ST (move) 2:STN 3:AND (logical product) 4:ANDN 5:OR (logical sum) 6:ORN 7:EQ (equal) 8:NE (not equal) 9:GT (greater than) 10:GE (greater or equal) 11:LT (less than) 12:LE (less or equal) 13:ASUB (absolute) 14:ON (on delay timer) 15:OFF (off delay timer) 16:COUNT 1 (counter 1) 17:COUNTR 2 (counter 2) 18:HOLD (hold) 19:SET (set) 20:RESET (reset) 21:CLR 22:CLR N	0		
A902	A902	Input function target 12	-	-	0-3099 (Same as A900)	0		
A903	A903	Input function command 13	-	-	0-22 (Same as A901)	0		
A904	A904	Input function target 13	-	-	0-3099 (Same as A900)	0		
A905	A905	Output function assigned object 1	-	-	0-3099 (Same as A900)	0		
A906	A906	Input function target 21	-	-	0-3099 (Same as A900)	0		
A907	A907	Input function command 22	-	-	0-22 (Same as A901)	0		
A908	A908	Input function target 22	-	-	0-3099 (Same as A900)	0		
A909	A909	Input function command 23	-	-	0-22 (Same as A901)	0		
A910	A910	Input function target 23	-	-	0-3099 (Same as A900)	0		
A911	A911	Output function assigned object 2	-	-	0-3099 (Same as A900)	0		

Title	Communication No.	Function	Unit	Minimum setting unit Panel/Communication	Adjustment range	Default setting	User setting	Reference
A912	A912	Input function target 31	-	-	0-3099 (Same as A900)	0		6.36
A913	A913	Input function command 32	-	-	0-22 (Same as A901)	0		
A914	A914	Input function target 32	-	-	0-3099 (Same as A900)	0		
A915	A915	Input function command 33	-	-	0-22 (Same as A901)	0		
A916	A916	Input function target 33	-	-	0-3099 (Same as A900)	0		
A917	A917	Output function assigned object 3	-	-	0-3099 (Same as A900)	0		
A918	A918	Output percent data 1	%	0.01/0.01	0.00-200.0	0.00		
A919	A919	Output percent data 2	%	0.01/0.01		0.00		
A920	A920	Output percent data 3	%	0.01/0.01		0.00		
A921	A921	Output percent data 4	%	0.01/0.01		0.00		
A922	A922	Output percent data 5	%	0.01/0.01		0.00		
A923	A923	Output frequency data 1	Hz	0.1/0.01	0.0-500.0	0.0		
A924	A924	Output frequency data 2	Hz	0.1/0.01		0.0		
A925	A925	Output frequency data 3	Hz	0.1/0.01		0.0		
A926	A926	Output frequency data 4	Hz	0.1/0.01		0.0		
A927	A927	Output frequency data 5	Hz	0.1/0.01		0.0		
A928	A928	Output time data 1	s	0.01/0.01	0.01-600.0	0.01		
A929	A929	Output time data 2	s	0.01/0.01		0.01		
A930	A930	Output time data 3	s	0.01/0.01		0.01		
A931	A931	Output time data 4	s	0.01/0.01		0.01		
A932	A932	Output time data 5	s	0.01/0.01		0.01		
A933	A933	Number of times of output data 1	times	1/1	0-9999	0		
A934	A934	Number of times of output data 2	times	1/1	0-9999	0		

Title	Communication No.	Function	Unit	Minimum setting unit Panel/Communication	Adjustment range	Default setting	User setting	Reference
R935	A935	Input function target 41	-	-	0-3099 (Same as R900)	0		6.36
R936	A936	Input function command 42	-	-	0-22 (Same as R900)	0		
R937	A937	Input function target 42	-	-	0-3099 (Same as R900)	0		
R938	A938	Input function command 43	-	-	0-22 (Same as R900)	0		
R939	A939	Input function target 43	-	-	0-3099 (Same as R900)	0		
R940	A940	Output function assigned object 4	-	-	0-3099 (Same as R900)	0		
R941	A941	Input function target 51	-	-	0-3099 (Same as R900)	0		
R942	A942	Input function command 52	-	-	0-22 (Same as R900)	0		
R943	A943	Input function target 52	-	-	0-3099 (Same as R900)	0		
R944	A944	Input function command 53	-	-	0-22 (Same as R900)	0		
R945	A945	Input function target 53	-	-	0-3099 (Same as R900)	0		
R946	A946	Output function assigned object 5	-	-	0-3099 (Same as R900)	0		
R947	A947	Input function target 61	-	-	0-3099 (Same as R900)	0		
R948	A948	Input function command 62	-	-	0-22 (Same as R900)	0		
R949	A949	Input function target 62	-	-	0-3099 (Same as R900)	0		
R950	A950	Input function command 63	-	-	0-22 (Same as R900)	0		
R951	A951	Input function target 63	-	-	0-3099 (Same as R900)	0		
R952	A952	Output function assigned object 6	-	-	0-3099 (Same as R900)	0		
R953	A953	Input function target 71	-	-	0-3099 (Same as R900)	0		
R954	A954	Input function command 72	-	-	0-22 (Same as R900)	0		
R955	A955	Input function target 72	-	-	0-3099 (Same as R900)	0		
R956	A956	Input function command 73	-	-	0-22 (Same as R900)	0		
R957	A957	Input function target 73	-	-	0-3099 (Same as R900)	0		
R958	A958	Output function assigned object 7	-	-	0-3099 (Same as R900)	0		
R973	A973	Virtual input terminal selection 1	-	-	0-203 *6	0		
R974	A974	Virtual input terminal selection 2	-	-		0		
R975	A975	Virtual input terminal selection 3	-	-		0		
R976	A976	Virtual input terminal selection 4	-	-		0		
R977	A977	Logic sequence function selection	-	-	0:Disabled 1: Logic sequence function + permission signal 2: Logic sequence function always ON	0		

*6: Refer to section 11.6 for details about input terminal function.

• Communication option parameters

Title	Function	Reference
$C000 - C119$	Communication option common parameters	6.33.5
$C150 - C199$	Profibus DP option parameters	
$C200 - C249$	DeviceNet option parameters	
$C500 - C549$	EtherNet common parameters	
$C550 - C599$	EtherNet IP option parameters	
$C600 - C649$	Modbus TCP option parameters	6.33.4
$C700 - C799$	CANopen communication parameters	

Note) Refer to each Instruction Manual for option about detailed specifications.

11.4 Default settings by inverter rating

Inverter type	Torque boost value	Dynamic braking resistance	Dynamic braking resistor capacity	Automatic torque boost value	Motor rated capacity	Motor rated current	Motor no-load current	Over-voltage stall protection level	Integrating wattmeter display unit selection
	$F172$ (%)	$F308$ (Ω)	$F309$ (kW)	$F402$ (%)	$F405$ (kW)	$F415$ (A)	$F416$ (%)	$F626$ (%)	$F749$
VFMB1S-2002PL	6.0	200.0	0.12	8.3	0.20	1.2	70	136	0
VFMB1S-2004PL	6.0	200.0	0.12	6.2	0.40	2.0	65	136	0
VFMB1S-2007PL	6.0	200.0	0.12	5.8	0.75	3.4	60	136	0
VFMB1S-2015PL	6.0	75.0	0.12	4.3	1.50	6.2	55	136	0
VFMB1S-2022PL	5.0	75.0	0.12	4.1	2.20	8.9	52	136	0
VFMB1-4004PL	6.0	200.0	0.12	6.2	0.40	1.0	65	141	0
VFMB1-4007PL	6.0	200.0	0.12	5.8	0.75	1.7	60	141	0
VFMB1-4015PL	6.0	200.0	0.12	4.3	1.50	2.4	55	141	0
VFMB1-4022PL	5.0	200.0	0.12	4.1	2.20	4.5	52	141	0
VFMB1-4037PL	5.0	160.0	0.12	3.4	4.00	7.4	48	141	1
VFMB1-4055PL	4.0	80.0	0.24	2.6	5.50	10.5	46	141	1
VFMB1-4075PL	3.0	60.0	0.44	2.3	7.50	14.1	43	141	1
VFMB1-4110PL	2.0	40.0	0.66	2.2	11.00	20.3	41	141	1
VFMB1-4150PL	2.0	30.0	0.88	1.9	15.00	27.3	38	141	1

11.5 Default settings by setup menu

Setting	Main regions	Frequency	Base frequency voltage 1 & 2		V/F control mode selection	Supply voltage correction (output voltage limitation)	Motor rated speed
		$UL, UL, F170, F204, F213, F219, F330, F367, F814$ (Hz)	$ULU, F171$ (V)				
			240V class	500V class	Pt	$F307$	$F417$ (min ⁻¹)
$F11$	Europe	50.0	230	400	0	2	1410
$F51R$	Asia	50.0	230	400	0	2	1410
$U5R$	North America	60.0	230	460	0	2	1710
JP	Japan	60.0	200	400	2	3	1710

Note) Refer to section 3.1 about setup menu.

11.6 Input Terminal Function

It can be assigned the function No. in the following table to parameter $F104, F108, F110$ to $F118, F151$ to $F156, R973$ to $R976$.

• Table of input terminal functions 1

Function No.	Code	Function	Action	Reference
0,1	-	No function	Disabled	-
2	F	Forward run command	ON: Forward run, OFF: Deceleration stop	3.2.1
3	FN	Inversion of forward run command	Inversion of F	7.2.1
4	R	Reverse run command	ON: Reverse run, OFF: Deceleration stop	
5	RN	Inversion of reverse run command	Inversion of R	
6	ST	Standby	ON: Ready for operation OFF: Coast stop (gate OFF)	3.2.1 6.3.1
7	STN	Inversion of standby	Inversion of ST	6.15.1
8	RES	Reset command	ON: Acceptance of reset command ON → OFF: Trip reset	13.2
9	RESN	Inversion of reset command	Inversion of RES	
10	SS1	Preset-speed command 1		3.6
11	SS1N	Inversion of preset-speed command 1		7.2.1
12	SS2	Preset-speed command 2		
13	SS2N	Inversion of preset-speed command 2		
14	SS3	Preset-speed command 3		
15	SS3N	Inversion of preset-speed command 3		
16	SS4	Preset-speed command 4		3.6
17	SS4N	Inversion of preset-speed command 4		
18	JOG	Jog run mode	ON: Jogging mode OFF: Jog run canceled	6.10
19	JOGN	Inversion of jog run mode	Inversion of JOG	
20	EXT	Emergency stop by external signal	ON: \bar{E} trip stop OFF: After stopped by $F603, \bar{E}$ trip	6.24.4
21	EXTN	Inversion of emergency stop by external signal	Inversion of EXT	
22	DB	DC braking command	ON: DC braking, OFF: Brake canceled	6.8.1
23	DBN	Inversion of DC braking command	Inversion of DB	
24	AD2	2nd acceleration/deceleration	ON: Acceleration/deceleration 2 OFF: Acceleration/deceleration 1	6.4.1 6.23.2
25	AD2N	Inversion of 2nd acceleration/deceleration	Inversion of AD2	
26	AD3	3rd acceleration/deceleration	ON: Acceleration/deceleration 3 OFF: Acceleration/deceleration 1 or 2	
27	AD3N	Inversion of 3rd acceleration/deceleration	Inversion of AD3	
28	VF2	2nd V/F control mode switching	ON: 2nd V/F control mode (V/F fixed, $F170, F171, F172, F173$) OFF: 1st V/F control mode (Pt setting, vL, vL, v, ub, tH)	6.4.1
29	VF2N	Inversion of 2nd V/F control switching	Inversion of VF2	
32	OCS2	2nd stall prevention level	ON: Enabled at the value of $F185$ OFF: Enabled at the value of $F601$	6.4.1 6.24.2
33	OCS2N	Inversion of 2nd stall prevention level	Inversion of OCS2	
36	PID	PID control prohibition	ON: PID control prohibited OFF: PID control enabled	6.20
37	PIDN	Inversion of PID control prohibition	Inversion of PID	
46	OH2	External thermal error input	ON: $\bar{OH}2$ trip stop, OFF: Disabled	7.2.1
47	OH2N	Inversion of external thermal error input	Inversion of $\bar{OH}2$	
48	SCLC	Forced local from communication	Enabled during communication ON: Local (Setting of $LR0d, FR0d$) OFF: Communication	5.6 6.33
49	SCLCN	Inversion of forced local from communication	Inversion of SCLC	
50	HD	Operation hold (hold of 3-wire operation)	ON: F (forward run), R: (reverse run) held, 3-wire operation OFF: Deceleration stop	7.2.1
51	HDN	Inversion of operation hold (hold of 3-wire operation)	Inversion of HD	

• Table of input terminal functions 2

Function No.	Code	Function	Action	Reference
52	IDC	PID integral/differential clear	ON: Integral/differential clear, OFF: Clear canceled	6.20
53	IDCN	Inversion of PID integral/differential clear	Inversion of IDC	
54	DR	PID characteristics switching	ON: Inverted characteristics of $F3B0$ selection OFF: Characteristics of $F3B0$ selection	6.25
55	DRN	Inversion of PID characteristics switching	Inversion of DR	
56	FORCE	Forced run operation	ON: Forced run operation if specified faults are occurred ($F294$ frequency) OFF: Normal operation	6.19
57	FORCEN	Inversion of forced run operation	Inversion of FORCE	
58	FIRE	Fire speed operation	ON: Fire speed operation ($F294$ frequency) OFF: Normal operation	6.19
59	FIREN	Inversion of fire speed operation	Inversion of FIRE	
60	DWELL	Acceleration/deceleration suspend signal	ON: Acceleration/deceleration suspend OFF: Normal operation	6.15.2
61	DWELLN	Inversion of acceleration/deceleration suspend signal	Inversion of DWELL	
62	KEB	Power failure synchronized signal	ON: Deceleration stop with synchronizing when power failure OFF: Normal operation	6.36
63	KEBN	Inversion of power failure synchronized signal	Inversion of KEB	
64	MYF	Logic sequence function trigger signal	ON: Trigger(start operation) signal of logic sequence function OFF: Normal operation	*1
65	MYFN	Inversion of logic sequence function trigger signal	Inversion of MYF	
70, 71		Factory specific coefficient	-	
74	CKWH	Integrating wattmeter(kwh) display clear	ON: Integrating wattmeter(kwh) monitor display clear OFF: Disabled	6.30
75	CKWHN	Inversion of integrating wattmeter display clear	Inversion of CKWH	
76	TRACE	Trace back trigger signal	ON: Trigger(start) signal of trace function OFF: Disabled	6.17
77	TRACEN	Inversion of trace back trigger signal	Inversion of TRACE	
78	HSLL	Light-load high-speed operation prohibitive signal	ON: Light-load high-speed operation prohibited OFF: Light-load high-speed operation permitted	7.2.2
79	HSLLN	Inversion of light-load high-speed operation prohibitive signal	Inversion of HSLL	
80	HDRY	Holding of RY-RC terminal output	ON: Once turned on, RY-RC are held on. OFF: The status of RY-RC changes in real time according to conditions.	7.2.1
81	HDRYN	Inversion of holding of RY-RC terminal output	Inversion of HDRY	
82	HDOU	Holding of OUT-NO terminal output	ON: Once turned on, OUT-NO are held on. OFF: The status of OUT-NO changes in real time according to conditions.	6.6.3
83	HDOU N	Inversion of holding of OUT-NO terminal output	Inversion of HDOU	
88	UP	Frequency UP	ON: Frequency increased OFF: Frequency increase canceled	6.6.3
89	UPN	Inversion of frequency UP	Inversion of UP	
90	DWN	Frequency DOWN	ON: Frequency decreased OFF: Frequency decrease canceled	6.6.3
91	DWNN	Inversion of frequency DOWN	Inversion of DWN	
92	CLR	Clear frequency UP/DOWN	OFF → ON: Clear frequency UP/DOWN	7.2.1
93	CLR N	Inversion of clear frequency UP/DOWN	Inversion of CLR	
96	FRR	Coast stop command	ON: Coast stop (Gate OFF) OFF: Coast stop canceled	3.2.1
97	FRRN	Inversion of coast stop command	Inversion of FRP	
98	FR	Forward/reverse selection	ON: Forward operation command OFF: Reverse operation command	7.2.1
99	FRN	Inversion of forward/reverse selection	Inversion of FR	

*1: Factory specific coefficient parameters are manufacturer setting parameters. Do not change the value of these parameters.

• Table of input terminal functions 3

Function No.	Code	Function	Action	Reference
100	RS	Run/Stop command	ON: Run command OFF: Stop command	7.2.1
101	RSN	Inversion of run/Stop command	Inversion of RS	
104	FCHG	Frequency reference command forced switching	ON: $F 2 0 1 (F 2 0 0 = 0)$ OFF: $F n 0 d$	5.6
105	FCHGN	Inversion of frequency reference command forced switching	Inversion of HDRY	
106	FMTB	Frequency setting mode terminal board	ON: Terminal board (VIA) enabled OFF: Setting of $F n 0 d$	
107	FMTBN	Inversion of frequency setting mode terminal board	Inversion of FMTB	
108	CMTB	Command mode terminal board	ON: Terminal board enabled OFF: Setting of $C n 0 d$	
109	CMTBN	Inversion of command mode terminal board	Inversion of CMTB	
110	PWE	Parameter editing permission	ON: Parameter editing permitted OFF: Setting of $F 7 0 0$	6.29.1
111	PWEN	Inversion of parameter editing permission	Inversion of PWE	
120	FSTP1	Fast stop command 1	ON: Dynamic quick deceleration command OFF: Forced deceleration canceled (Note that operation is resumed when forced deceleration is canceled)	5.4.1
121	FSTP1N	Inversion of fast stop command 1	Inversion of FSTP1	
122	FSTP2	Fast stop command 2	ON: Automatic deceleration OFF: Forced deceleration canceled (Note that operation is resumed when forced deceleration is canceled)	
123	FSTP2N	Inversion of fast stop command 2	Inversion of FST	
134	TVS	Traverse permission signal	ON: Permission signal of traverse operation OFF: Normal operation	6.35
135	TVSN	Inversion of traverse permission signal	Inversion of TVS	
136, 137		Factory specific coefficient	-	*1
140	SLOWF	Forward deceleration	ON: Forward operation with $F 3 8 3$ frequency OFF: Normal operation	6.18.2
141	SLOWFN	Inversion of forward deceleration	Inversion of SLOWF	
142	STOPF	Forward stop	ON: Forward stop OFF: Normal operation	
143	STOPFN	Inversion of forward stop	Inversion of STOPF	
144	SLOWR	Reverse deceleration	ON: Reverse operation with $F 3 8 3$ frequency OFF: Normal operation	
145	SLOWRN	Inversion of reverse deceleration	Inversion of SLOWR	
146	STOPR	Reverse stop	ON: Reverse stop OFF: Normal operation	
147	STOPRN	Inversion of reverse stop	Inversion of STOPR	
148 to 151		Factory specific coefficient	-	*1
200	PWP	Parameter editing prohibition	ON: Parameter editing prohibited OFF: Setting of $F 7 0 0$	6.29.1
201	PWPN	Inversion of parameter editing prohibition	Inversion of PWP	
202	PRWP	Parameter reading prohibition	ON: Parameter reading / editing prohibited OFF: Setting of $F 7 0 0$	
203	PRWPN	Inversion of parameter reading prohibition	Inversion of PRWP	

*1: Factory specific coefficient parameters are manufacturer setting parameters. Do not change the value of these parameters.

Note 1: Function No. that are not described in the table above are assigned "No function".

• Input terminal function priority

Code	Function No.	2,3 4,5	6,7	8,9	10,11 12,13 14,15 16,17	18 19	20 21	22 23	24,25 28,29 32,33	36,37 52,53 54,55	48 49 106 107 108 109	50 51	88,89 90,91 92,93	96 97	110 111 200 201	122 123
F/ R	2,3 4,5		X	○	○	○	X	X	○	○	○	○	○	X	○	X
ST	6,7	⊙		○	⊙	⊙	○	⊙	○	○	○	⊙	○	○	○	⊙
RES	8,9	○	○		○	○	X	○	○	○	○	○	○	○	○	○
SS1/ SS2/ SS3/ SS4	10,11 12,13 14,15 16,17	○	X	○		X	X	X	○	○	○	○	○	X	○	X
JOG	18,19	○	X	○	⊙		X	X	○	⊙	○	X	○	X	○	X
EXT	20,21	⊙	○	⊙	⊙	⊙		⊙	○	○	○	⊙	○	○	○	⊙
DB	22,23	⊙	X	○	⊙	⊙	X		○	⊙	○	⊙	○	X	○	X
AD2/ VF2/ OCS2	24,25 28,29 32,33	○	○	○	○	○	○	○		○	○	○	○	○	○	○
PID/ IDC/ PIDSW	36,37 52,53 54,55	○	○	○	○	X	○	X	○		○	○	○	○	○	○
SCLC/ FMTB/ MTB	48,49 106,107 108,109	○	○	○	○	○	○	○	○	○		○	○	○	○	○
HD	50,51	○	X	○	○	X	X	X	○	○	○		○	X	○	X
UP/ DWN/ CLR	88,89 90,91 92,93	○	○	○	○	○	○	○	○	○	○	○		○	○	○
FRR	96,97	⊙	○	○	⊙	⊙	○	⊙	○	○	○	⊙	○		○	⊙
PWE/ PWP	110,111 200,201	○	○	○	○	○	○	○	○	○	○	○	○	○	○	○
FST	122,123	⊙	X	○	⊙	⊙	X	⊙	○	○	○	⊙	○	X	○	

⊙ Priority ○ Enabled X Disabled

11.7 Output Terminal Function

It can be assigned the function No. in the following table to parameter $F 130$ to $F 138$, $F 157$, $F 158$.

• Table of output terminal functions 1

Function No.	Code	Function	Action	Reference
0	LL	Frequency lower limit	ON: Output frequency is more than $L L$ OFF: Output frequency is $L L$ or less	5.10
1	LLN	Inversion of frequency lower limit	Inversion of LL	
2	UL	Frequency upper limit	ON: Output frequency is $U L$ or more OFF: Output frequency is less than $U L$	
3	ULN	Inversion of frequency upper limit	Inversion of UL	
4	LOW	Low-speed detection signal	ON: Output frequency is $F 100$ or more OFF: Output frequency is less than $F 100$	6.1.1 7.2.2
5	LOWN	Inversion of low-speed detection signal	Inversion of LOW	
6	RCH	Output frequency attainment signal (acceleration/deceleration completed)	ON: Output frequency is within command frequency $\pm F 102$ OFF: Output frequency is more than command frequency $\pm F 102$	6.1.2 7.2.2
7	RCHN	Inversion of output frequency attainment signal (inversion of acceleration/deceleration completed)	Inversion of RCHF	
8	RCHF	Set frequency attainment signal	ON: Output frequency is within $F 101 \pm F 102$ OFF: Output frequency is more than $F 101 \pm F 102$	6.1.3
9	RCHFN	Inversion of set frequency attainment signal	Inversion of RCHF	
10	FL	Fault signal (trip output)	ON: Inverter tripped OFF: Inverter not tripped	7.2.2
11	FLN	Inversion of fault signal (inversion of trip output)	Inversion of FL	
14	POC	Over-current pre-alarm	ON: Output current is $F 601$ or more OFF: Output current is less than $F 601$	6.24.2
15	POCN	Inversion of over-current pre-alarm	Inversion of POC	
16	POL	Overload detection pre-alarm	ON: $F 657$ (%) or more of calculated value of overload protection level OFF: Less than $F 657$ (%) of calculated value of overload protection level	3.5
17	POLN	Inversion overload pre-alarm	Inversion of POL	
20	POH	Overheat pre-alarm	ON: Approx. 95°C or more of IGBT element OFF: Less than approx. 95°C of IGBT element (90°C or less after detection is turned on)	7.2.2
21	POHN	Inversion of overheat pre-alarm	Inversion of POH	
22	POP	Overvoltage pre-alarm	ON: Overvoltage limit in operation OFF: Overvoltage detection canceled	6.15.5
23	POPEN	Inversion of overvoltage pre-alarm	Inversion of POP	
24	MOFF	Power circuit undervoltage detection	ON: Power circuit undervoltage (MOFF) detected OFF: Undervoltage detection canceled	6.24.12
25	MOFFN	Inversion of power circuit undervoltage detection	Inversion of MOFF	
26	UC	Small current detection	ON: After output current comes to $F 611$ or less, value of less than $F 611 + F 609$ for $F 612$ set time OFF: Output current is more than $F 611$ ($F 611 + F 609$ or more after detection turns on)	6.24.7
27	UCN	Inversion of small current detection	Inversion of UC	
28	OT	Over-torque detection	ON: After torque comes to $F 616$ or more, value of more than $F 616 - F 619$ for $F 618$ set time OFF: Torque is less than $F 616$ ($F 616 - F 619$ or less after detection turns on)	6.24.9
29	OTN	Inversion of over-torque detection	Inversion of OT	

• Table of output terminal functions 2

Function No.	Code	Function	Action	Reference
30	POLR	Braking resistor overload pre-alarm	ON: 50% or more of calculated value of $F309$ set overload protection level OFF: Less than 50% of calculated value of $F309$ set overload protection level	6.15.4
31	POLRN	Inversion of braking resistor overload pre-alarm	Inversion of POLR setting	
40	RUN	Run/stop	ON: While operation frequency is output or DC braking is in operation (db) OFF: Operation stopped	7.2.2
41	RUNN	Inversion of run/stop	Inversion of RUN	
42	HFL	Heavy fault	ON: At trip ($DCR, DCL, DE, EEP1, EEn, EPH0, Err2 \sim 5, GH2, UP1, EF2, UC, E49P, EPH1$) OFF: Other than those trip above	
43	HFLN	Inversion of heavy fault	Inversion of HFL	
44	LFL	Light fault	ON: At trip ($DC1 \sim 3, DP1 \sim 3, GH, DL1 \sim 3, DLR$) OFF: Other than those trip above	
45	LFLN	Inversion of light fault	Inversion of LFL	
50	FAN	Cooling fan ON/OFF	ON: Cooling fan is in operation OFF: Cooling fan is off operation	6.24.10
51	FANN	Inversion of Cooling fan ON/OFF	Inversion of FAN	
52	JOG	In jogging operation	ON: In jogging operation OFF: Other than jogging operation	6.10
53	JOGN	Inversion of in jogging operation	Inversion of JOG	
54	JBM	Operation panel / terminal board operation	ON: At terminal board operation command OFF: Other than those operation above	5.6
55	JBMN	Inversion of operation panel/terminal board operation	Inversion of JBM	
56	COT	Cumulative operation time alarm	ON: Cumulative operation time is $F621$ or more OFF: The cumulative operation time is less than $F621$	6.24.11
57	COTN	Inversion of cumulative operation time alarm	Inversion of COT	
58	COMOP	Communication option communication error	ON: Communication error of communication option occurs OFF: Other than those above	6.33
59	COMOPN	Inversion of communication option communication error	Inversion of COMOP	
60	FR	Forward/reverse run	ON: Reverse run OFF: Forward run (Operation command state is output while motor operation is stopped. No command is to OFF.)	7.2.2
61	FRN	Inversion of forward/reverse run	Inversion of FR	
62	RDY1	Ready for operation 1	ON: Ready for operation (with ST / RUN) OFF: Other than those above	
63	RDY1N	Inversion of ready for operation 1	Inversion of RDY1	
64	RDY2	Ready for operation 2	ON: Ready for operation (without ST / RUN) OFF: Other than those above	
65	RDY2N	Inversion of ready for operation 2	Inversion of RDY2	
68	BR	Brake release	ON: Brake exciting signal OFF: Brake releasing signal	6.18
69	BRN	Inversion of brake release	Inversion of BR	
70	PAL	Pre-alarm	ON: One of the following is turned on ON POL, POHR, POT, MOFF, UC, OT, LL stop, COT, and momentary power failure deceleration stop. Or $\underline{L}, \underline{P}, \underline{D}, \underline{H}$ issues an alarm OFF: Other than those above	7.2.2
71	PALN	Inversion of pre-alarm	Inversion of PAL	
78	COME	RS485 communication error	ON: Communication error occurred OFF: Communication works	6.33
79	COMEN	Inversion of RS485 communication error	Inversion of COME	

• Table of output terminal functions 3

Function No.	Code	Function	Action	Reference
92	DATA1	Designated data output 1	ON: bit0 of FA50 is ON OFF: bit0 of FA50 is OFF	6.33
93	DATA1N	Inversion of designated data output 1	Inversion of DATA	
94	DATA2	Designated data output 2	ON: bit1 of FA50 is ON OFF: bit1 of FA50 is OFF	6.17
95	DATA2N	Inversion of designated data output 2	Inversion of DATA2	
106	LLD	Light load output	ON: Less than heavy load torque ($F335 \sim F338$) OFF: heavy load torque ($F335 \sim F338$) or more	6.17
107	LLDN	Inversion of light load output	Inversion of LLD	
108	HLD	Heavy load output	ON: Heavy load torque ($F335 \sim F338$) or more OFF: Less than heavy load torque ($F335 \sim F338$)	6.9.1
109	HLDN	Inversion of heavy load output	Inversion of HLD	
120	LLS	Lower limit frequency stop	ON: Lower limit frequency continuous operation OFF: Other than those above	6.15.2
121	LLSN	Inversion of lower limit frequency stop	Inversion of LLS	
122	KEB	Power failure synchronized operation	ON: Power failure synchronized operation OFF: Other than those above	6.35
123	KEBN	Inversion of power failure synchronized operation	Inversion of KEB	
124	TVS	Traverse in progress	ON: Traverse in progress OFF: Other than those above	6.24.14
125	TVSN	Inversion of traverse in progress	Inversion of TVS	
126	TVSD	Traverse deceleration in progress	ON: Traverse deceleration in progress OFF: Other than those above	6.24.9
127	TVSDN	Inversion of traverse deceleration in progress	Inversion of TVSD	
128	LTA	Parts replacement alarm	ON: Any one of cooling fan, control board capacitor, or main circuit capacitor reaches parts replacement time OFF: Any one of cooling fan, control board capacitor, or main circuit capacitor does not reach parts replacement time	6.24.9
129	LTAN	Inversion of parts replacement alarm	Inversion of LTA	
130	POT	Over-torque detection pre-alarm	ON: Torque current is 70% of $F615$ setting value or more OFF: Torque current is less than $F615 \times 70\% - F619$	5.6
131	POTN	Inversion of over-torque detection pre-alarm	Inversion of POT	
132	FMOD	Frequency setting mode selection 1/2	ON: Select frequency setting mode selection 2 ($F207$) OFF: Select frequency setting mode selection 1 ($F10d$)	5.6
133	FMODN	Inversion of frequency setting mode selection 1/2	Inversion of FMOD	
136	FLC	Panel / remote selection	ON: Operation command or panel OFF: Other than those above	6.25
137	FLCN	Inversion of panel / remote selection	Inversion of FLC	
138	FORCE	Forced continuous operation in progress	ON: Forced continuous operation in progress OFF: Other than those above	6.25
139	FORCEN	Inversion of forced continuous operation in progress	Inversion of FORCE	
140	FIRE	Specified frequency operation in progress	ON: Specified Frequency operation in progress OFF: Other than those above	6.25
141	FIREN	Inversion of specified frequency operation in progress	Inversion of FIRE	

• Table of output terminal functions 4

Function No.	Code	Function	Action	Reference
144	PIDF	Signal in accordance of frequency command	ON: Frequency commanded by $F 3 8 9$ and $F 3 6 9$ are within $\pm F 1 5 7$. OFF: Other than those above	6.3.4 6.20
145	PIDFN	Inversion of signal in accordance of frequency command	Inversion of PIDF setting	
146	FLR	Fault signal (output also at a retry waiting)	ON: While inverter is tripped or retried OFF: While inverter is not tripped and not retried	6.15.3
147	FLRN	Inversion of fault signal (output also at a retry waiting)	Inversion of FLR	
150	PTCA	PTC input alarm signal	ON: PTC thermal input value is $F 5 4 6$ or more OFF: PTC thermal input value is less than $F 5 4 6$	6.24.15
151	PTCAN	Inversion of PTC input alarm signal	Inversion of POT	
152	STO	Safe torque off signal	ON: Safe torque off signal output OFF: Other than those above	9.3
153	STON	Inversion of safe torque off signal	Inversion of FMOD	
154	DISK	Analog input break detection alarm	ON: VIB terminal input value is $F 5 3 3$ or less OFF: VIB terminal input value is more than $F 5 3 3$	6.24.13
155	DISKN	Inversion of Analog input break detection alarm	Inversion of FLC	
156	LI1	F terminal state	ON: F terminal is ON state OFF: F terminal is OFF state	7.2.2
157	LI1N	Inversion of F terminal status	Inversion of FORCE	
158	LI2	R terminal status	ON: R terminal is ON state OFF: R terminal is OFF state	
159	LI2N	Inversion of R terminal status	Inversion of FIRE	
160	LTAF	Cooling fan replacement alarm	ON: Cooling fan reaches parts replacement time OFF: Cooling fan does not reach parts replacement time	6.24.14
161	LTAFN	Inversion of cooling fan replacement alarm	Inversion of PIDF	
162	NSA	Number of starting alarm	ON: Number of starting alarm is $F 5 4 8$ or more OFF: Number of starting alarm is less than $F 5 4 8$	6.24.16
163	NSAN	Inversion of number of starting alarm	Inversion of NSA	
166	DACC	Acceleration operation in progress	ON: Acceleration operation in progress OFF: Other than those above	7.2.2
167	DACCN	Inversion of acceleration operation in progress	Inversion of DACC	
168	DDEC	Deceleration operation in progress	ON: Deceleration operation in progress OFF: Other than those above	
169	DDECN	Inversion of deceleration operation in progress	Inversion of DDEC	
170	DRUN	Constant speed operation in progress	ON: Constant speed operation in progress OFF: Other than those above	
171	DRUNN	Inversion of constant speed operation in progress	Inversion of DRUN	
172	DDC	DC braking in progress	ON: DC braking in progress OFF: Other than those above	6.8.1
173	DDCN	Inversion of DC braking in progress	Inversion of DDC	
174 to 179		Factory specific coefficient	-	*1

*1: Factory specific coefficient parameters are manufacturer setting parameters. Do not change the value of these parameters.

• Table of output terminal functions 5

Function No.	Code	Function	Action	Reference
222	LSFO1	Logic sequence function output 1	ON: Logic sequence function output 1 is ON OFF: Logic sequence function output 1 is OFF	6.36
223	LSFO1N	Inversion of logic sequence function output 1	Inversion of LSFO1	
224	LSFO2	Logic sequence function output 2	ON: Logic sequence function output 2 is ON OFF: Logic sequence function output 2 is OFF	
225	LSFO2N	Inversion of logic sequence function output 2	Inversion of LSFO2	
226	LSFO3	Logic sequence function output 3	ON: Logic sequence function output 3 is ON OFF: Logic sequence function output 3 is OFF	
227	LSFO3N	Inversion of logic sequence function output 3	Inversion of LSFO3	
228	LSFO4	Logic sequence function output 4	ON: Logic sequence function output 4 is ON OFF: Logic sequence function output 4 is OFF	
229	LSFO4N	Inversion of logic sequence function output 4	Inversion of LSFO4	
230	LSFO5	Logic sequence function output 5	ON: Logic sequence function output 5 is ON OFF: Logic sequence function output 5 is OFF	
231	LSFO5N	Inversion of logic sequence function output 5	Inversion of LSFO5	
232	LSFO6	Logic sequence function output 6	ON: Logic sequence function output 6 is ON OFF: Logic sequence function output 6 is OFF	
233	LSFO6N	Inversion of logic sequence function output 6	Inversion of LSFO6	
234	LSFO7	Logic sequence function output 7	ON: Logic sequence function output 7 is ON OFF: Logic sequence function output 7 is OFF	
235	LSFO7N	Inversion of logic sequence function output 7	Inversion of LSFO7	
236	LSFO8	Logic sequence function output 8	ON: Logic sequence function output 8 is ON OFF: Logic sequence function output 8 is OFF	
237	LSFO8N	Inversion of logic sequence function output 8	Inversion of LSFO8	
238	LSFO9	Logic sequence function output 9	ON: Logic sequence function output 9 is ON OFF: Logic sequence function output 9 is OFF	
239	LSFO9N	Inversion of logic sequence function output 9	Inversion of LSFO9	
240	LSFO10	Logic sequence function output 10	ON: Logic sequence function output 10 is ON OFF: Logic sequence function output 10 is OFF	
241	LSFO10N	Inversion of logic sequence function output 10	Inversion of LSFO10	
242	LSFO11	Logic sequence function output 11	ON: Logic sequence function output 11 is ON OFF: Logic sequence function output 11 is OFF	
243	LSFO11N	Inversion of logic sequence function output 11	Inversion of LSFO11	
244	LSFO12	Logic sequence function output 12	ON: Logic sequence function output 12 is ON OFF: Logic sequence function output 12 is OFF	
245	LSFO12N	Inversion of logic sequence function output 12	Inversion of LSFO12	
246	LSFO13	Logic sequence function output 13	ON: Logic sequence function output 13 is ON OFF: Logic sequence function output 13 is OFF	
247	LSFO13N	Inversion of logic sequence function output 13	Inversion of LSFO13	
248	LSFO14	Logic sequence function output 14	ON: Logic sequence function output 14 is ON OFF: Logic sequence function output 14 is OFF	
249	LSFO14N	Inversion of logic sequence function output 14	Inversion of LSFO14	
250	LSFO15	Logic sequence function output 15	ON: Logic sequence function output 15 is ON OFF: Logic sequence function output 15 is OFF	
251	LSFO15N	Inversion of logic sequence function output 15	Inversion of LSFO15	
252	LSFO16	Logic sequence function output 16	ON: Logic sequence function output 16 is ON OFF: Logic sequence function output 16 is OFF	
253	LSFO16N	Inversion of logic sequence function output 16	Inversion of LSFO16	
254	AOFF	Always OFF	Always OFF	7.2.2
255	AON	Always ON	Always ON	

Note 1: As function No. that are not described in the table above are assigned "No function", output signal is always "OFF" at even number, output signal is always "ON" at odd number.

12. Specifications

12.1 Models and their standard specifications

■ Standard specifications

Item		Specification				
Input voltage class		1-phase 240V class				
Applicable motor (kW)		0.2	0.4	0.75	1.5	2.2
Rating	Type	VFMB1S				
	Form	2002PL	2004PL	2007PL	2015PL	2022PL
	Capacity (kVA) Note 1)	0.6	1.3	1.8	3.0	4.2
	Output current (A) Note 2)	1.5 (1.5)	3.3 (3.3)	4.8 (4.8)	8.0 (8.0)	11.0 (11.0)
	Output voltage Note 3)	3-phase 200V to 240V				
Overload current rating	150%-60 seconds, 200%-0.5 second					
Power supply	Voltage-frequency	1-phase 200V to 240V - 50/60Hz				
	Allowable fluctuation	Voltage 170 to 264V Note 4), frequency $\pm 5\%$				
	Required Power supply capacity (kVA) Note 5)	0.8	1.4	2.3	4.0	5.4
Protective method (IEC60529)		IP20				
Cooling method		Forced air-cooled				
Color		RAL7016				
Built-in filter		EMC filter				

Item		Specification								
Input voltage class		3-phase 500V class								
Applicable motor (kW)		0.4	0.75	1.5	2.2	4.0	5.5	7.5	11	15
Rating	Type	VFMB1								
	Form	4004PL	4007PL	4015PL	4022PL	4037PL	4055PL	4075PL	4110PL	4150PL
	Capacity (kVA) Note 1)	1.1	1.8	3.1	4.2	7.2	11	13	21	25
	Output current (A) Note 2)	1.5 (1.5)	2.3 (2.3)	4.1 (4.1)	5.5 (5.5)	9.5 (9.5)	14.3 (17.0)	17.0 (23.0)	27.7 (33.0)	33.0 (40.0)
	Output voltage Note 3)	3-phase 380V to 500V								
Overload current rating	150%-60 seconds, 200%-0.5 second									
Power supply	Voltage-frequency	3-phase 380V to 500V - 50/60Hz								
	Allowable fluctuation	Voltage 323 to 550V Note 4), frequency $\pm 5\%$								
	Required Power supply capacity (kVA) Note 5)	1.6	2.6	4.7	6.3	10.1	15.2	19.6	26.9	34.9
Protective method (IEC60529)		IP20								
Cooling method		Forced air-cooled								
Color		RAL7016								
Built-in filter		EMC filter								

Note 1. Capacity is calculated at 220V for the 240V models, at 440V for the 500V models.

Note 2. It is a value when the inverter overload characteristic selection (parameter $R U L$) is the constant torque characteristic. Value in () for the variable torque characteristic.

The output current must be reduced according to the PWM carrier frequency, ambient temperature and supply voltage. (Refer to section 6.14)

Note 3. Maximum output voltage is the same as the input voltage.

Note 4. At 180V-264V for the 240V models, at 342V-550V for the 500V models when the inverter is used continuously (load of 100%).

Note 5. Required power supply capacity varies with the value of the power supply side inverter impedance (including those of the input reactor and cables).

■ Common specification

	Item	Specification
Principal control functions	Control system	Sinusoidal PWM control
	Output voltage range (Note1)	Adjustable within the range of 50 to 330V (240V class) and 50 to 660V (500V class) by correcting the supply voltage
	Output frequency range	0.1 to 500.0Hz, default setting: 0.5 to 80Hz, maximum frequency: 30 to 500Hz
	Minimum setting steps of frequency	0.1Hz: analog input (when the max. frequency is 100Hz), 0.01Hz: Operation panel setting and communication setting.
	Frequency accuracy	Digital setting: within $\pm 0.01\%$ of the max. frequency (-10 to +60°C) Analog setting: within $\pm 0.5\%$ of the max. frequency (25°C $\pm 10^\circ\text{C}$)
	Voltage/frequency characteristics	V/f constant, variable torque, automatic torque boost, vector control, automatic energy-saving, dynamic automatic energy-saving control, PM motor control, V/F 5-point setting, Auto-tuning. Base frequency (20-500Hz) adjusting to 1 & 2, torque boost (0-30%) adjusting to 1 & 2, adjusting frequency at start (0.1-10Hz)
	Frequency setting signal	Setting dial on the front panel, external frequency potentiometer (connectable to a potentiometer with a rated impedance of 1k-10k Ω), 0-10Vdc / -10-+10Vdc (input impedance: 30k Ω), 4-20mAdc (input impedance: 250 Ω).
	Terminal board base frequency	The characteristic can be set arbitrarily by two-point setting. Possible to set: analog input (VIA, VIB, VIC).
	Frequency jump	Three frequencies can be set. Setting of the jump frequency and the range.
	Upper- and lower-limit frequencies	Upper-limit frequency: 0 to max. frequency, lower-limit frequency: 0 to upper-limit frequency
PWM carrier frequency	Adjustable range of 2.0k to 16.0kHz (default: 4.0kHz).	
PID control	Setting of proportional gain, integral gain, differential gain and control wait time. Checking whether the amount of processing amount and the amount of feedback agree.	
Operation specifications	Acceleration/deceleration time	Selectable from among acceleration/deceleration times 1 & 2 & 3 (0.0 to 3600 sec.). Automatic acceleration/deceleration function. S-pattern acceleration/deceleration 1 & 2 and S-pattern adjustable. Control of forced rapid deceleration and dynamic rapid deceleration.
	DC braking	Braking start-up frequency: 0 to maximum frequency, braking rate: 0 to 100%, braking time: 0 to 25.5 seconds, emergency DC braking, motor shaft fixing control.
	Dynamic Braking Drive Circuit	Control and drive circuit is built in the inverter with the braking resistor outside (optional).
	Input terminal function (programmable)	Possible to select from among about 110 functions, such as forward/reverse run signal input, jog run signal input, operation base signal input and reset signal input, to assign to 8 input terminals. Logic selectable between sink and source.
	Output terminal functions (programmable)	Possible to select from among about 150 functions, such as upper/lower limit frequency signal output, low speed detection signal output, specified speed reach signal output and failure signal output, to assign to FL relay output, open collector output terminal, and RY output terminals.
	Forward/reverse run	The RUN and STOP keys on the operation panel are used to start and stop operation, respectively. Forward/reverse run possible through communication and logic inputs from the terminal block.
	Jog run	Jog mode, if selected, allows jog operation from the terminal board and also from remote keypad.
	Preset speed operation	Base frequency + 15-speed operation possible by changing the combination of 4 contacts on the terminal board.
	Retry operation	Capable of restarting automatically after a check of the main circuit elements in case the protective function is activated. 10 times (Max.) (selectable with a parameter)
	Various prohibition settings / Password setting	Possible to write-protect parameters and to prohibit the change of panel frequency settings and the use of operation panel for operation, emergency stop or resetting. Possible to write-protect parameters by setting 4 digits password and terminal input.
	Regenerative power ride-through control	Possible to keep the motor running using its regenerative energy in case of a momentary power failure (default: OFF).
	Auto-restart operation	In the event of a momentary power failure, the inverter reads the rotational speed of the coasting motor and outputs a frequency appropriate to the rotational speed in order to restart the motor smoothly. This function can also be used when switching to commercial power.
	Light-load high-speed operation	Increases the operating efficiency of the machine by increasing the rotational speed of the motor when it is operated under light load.
	Drooping function	When two or more inverters are used to operate a single load, this function prevents load from concentrating on one inverter due to unbalance.
Override function	External input signal adjustment is possible to the operation frequency command value.	
Relay output signal	1c- contact output and 1a- contact output: Note2) Maximum switching capacity : 250Vac-2A, 30Vdc-1A (At resistive load $\cos\phi=1$), 250Vac-1A ($\cos\phi=0.4$) Minimum permissible load : 5Vdc-100mA, 24Vdc-5mA	

<Continued overleaf>

<Continued>

	Item	Specification
Protective function	Protective function	Stall prevention, current limitation, over-current, output short circuit, over-voltage, over-voltage limitation, undervoltage, ground fault, detection, input phase failure, output phase failure, overload protection by electronic thermal function, armature over-current at start-up, load side over-current at start-up, over-torque, undercurrent, overheating, cumulative operation time, life alarm, emergency stop, various pre-alarms
	Electronic thermal characteristic Reset function	Switching between standard motor and constant-torque VF motor, switching between motors 1 & 2, setting of overload trip time, adjustment of stall prevention levels 1 & 2, selection of overload stall Function of resetting by closing contact 1a or by turning off power of the operation panel. This function is also used to save and clear trip records.
Display function	Alarms	Stall prevention, overvoltage, overload, under-voltage, setting error, retry in process, upper/lower limits
	Causes of failures	Over-current, overvoltage, overheat, output short-circuit, ground fault, overload on inverter, arm overcurrent at start-up, overcurrent on the load side at start-up, CPU fault, EEPROM fault, RAM fault, ROM fault, communication error. (Selectable: emergency stop, under-voltage, small current, over-torque, motor overload, input phase failure, output phase failure)
	Monitoring function	Operation frequency, operation frequency command, forward/reverse run, output current, input voltage (DC detection), output voltage, torque, torque current, load factor of inverter, input power, output power, information on input terminals, information on output terminals, logic input terminals setting, version of CPU1, version of CPU2, PID feedback value, frequency command (after compensation), causes of past trips 1 to 8, parts replacement alarm, cumulative operation time
	Past trip monitoring function	Stores data on the past eight trips: number of trips that occurred in succession, operation frequency, forward/reverse run, output current, input voltage (DC detection), output voltage, information on input terminals, information on output terminals, and cumulative operation time when each trip occurred.
	Output for frequency meter	Analog output for motor: 1mA dc full-scale dc ammeter 0 - 20mA (4 to 20mA) output: DC ammeter (allowable load resistance: Less than 750Ω) 0 - 10V output: DC voltmeter (allowable load resistance: Over 1kΩ) Resolution: Maximum of 1/1000
	4-digit 7-segments LED	Frequency: inverter output frequency. Alarm: stall alarm "C", overvoltage alarm "P", overload alarm "L", overheat alarm "H". Status: inverter status (frequency, cause of activation of protective function, input/output voltage, output current, etc.) and parameter settings. Free-unit display: arbitrary unit (e.g. rotating speed) corresponding to output frequency.
Indicator	Lamps indicating the inverter status by lighting, such as RUN lamp, MON lamp, PRG lamp, % lamp, Hz lamp. The charge lamp indicates that the main circuit capacitors are electrically charged.	
Environments	Location of use	Indoors; not exposed to direct sunlight, corrosive gas, explosive gas, flammable gas, oil mist, or dust; and vibration of less than 5.9m/s ² (10 to 55Hz).
	Elevation	3000 m or less (current reduction required over 1000 m) Note 3)
	Ambient temperature	-10 to +60°C Note 4)
	Storage temperature	-25 to +70°C
	Relative humidity	5 to 95% (free from condensation and vapor).

Note 1. Maximum output voltage is the same as the input voltage.

Note 2. A chattering (momentary ON/OFF of contact) is generated by external factors of the vibration and the impact, etc. In particular, please set the filter of 10ms or more, or timer for measures when connecting it directly with input unit terminal of programmable controller. Please use the OUT terminal as much as possible when the programmable controller is connected.

Note 3. Current must be reduced by 1% for each 100 m over 1000 m. For example, 90% at 2000m and 80% at 3000m.

Note 4. Above 50°C: Use the inverter with the output current reduced.

Side by side installation (with no space between inverters): Use the inverter with the output current reduced. (Refer to section 6.14 for details)

12.2 Outside dimensions and mass

■ Outside dimensions and mass

Voltage class	Applicable motor (kW)	Inverter type	Dimensions (mm)						Drawing	Approx. weight (kg)
			W	H	D	W1	H1	H2		
1-phase 240V	0.2	VFMB1S-2002PL	45	270	232	29	258	47	A	1.7
	0.4	VFMB1S-2004PL				29				1.8
	0.75	VFMB1S-2007PL	60		42	2.1				
	1.5	VFMB1S-2015PL			42	2.2				
	2.2	VFMB1S-2022PL			42	2.2				
3-phase 500V	0.4	VFMB1-4004PL	45	270	232	29	258	47	A	1.8
	0.75	VFMB1-4007PL				29				1.9
	1.5	VFMB1-4015PL				42				2.2
	2.2	VFMB1-4022PL	60			42	2.4			
	4.0	VFMB1-4037PL						130	210	12
	5.5	VFMB1-4055PL	150	220	160	295	20	D	6.8	
	7.5	VFMB1-4075PL							6.9	
	11	VFMB1-4110PL							6.9	
	15	VFMB1-4150PL	180	310	180	310	20	D	6.9	

Note. H dimension in Fig. C is not included in the protuberance for operation panel.

■ Outline drawing

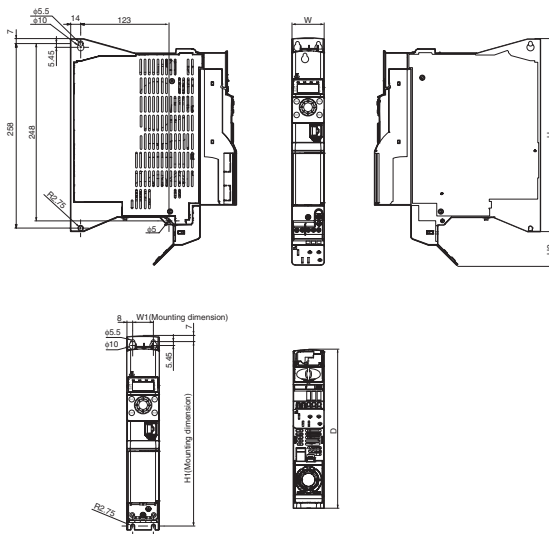

Fig.A

13. Before making a service call

- Trip information and remedies

13.1 Trip causes/warnings and remedies

When a problem arises, diagnose it in accordance with the following table.

If it is found that replacement of parts is required or the problem cannot be solved by any remedy described in the table, contact your Toshiba dealer.

[Trip information]				
Error code	Failure code	Problem	Possible causes	Remedies
<i>0C1</i>	0001	Overcurrent during acceleration	<ul style="list-style-type: none"> The acceleration time <i>REt</i> is too short. The V/F setting is improper. A restart signal is input to the rotating motor after a momentary stop, etc. A special motor (e.g. motor with a small impedance) is used. 	<ul style="list-style-type: none"> Increase the acceleration time <i>REt</i>. Check the V/F parameter. Use <i>F301</i> (auto-restart) and <i>F302</i> (ride-through control). In case of <i>PE=0, 1, 7</i>, decrease <i>ub</i>. In case of <i>PE=2 to 6</i>, set <i>F415</i> (Motor rated current) and make an auto-tuning.
<i>0C2</i>	0002	Overcurrent during deceleration	<ul style="list-style-type: none"> The deceleration time <i>dEt</i> is too short. 	<ul style="list-style-type: none"> Increase the deceleration time <i>dEt</i>.
<i>0C3</i>	0003	Overcurrent during constant speed operation	<ul style="list-style-type: none"> The load fluctuates abruptly. The load is in an abnormal condition. 	<ul style="list-style-type: none"> Reduce the load fluctuation. Check the load (operated machine).
<i>0CL</i>	0004	Overcurrent (An overcurrent on the load side at start-up)	<ul style="list-style-type: none"> The insulation of the output main circuit or motor is defective. The motor has too small impedance. 	<ul style="list-style-type: none"> Check the secondary wiring and insulation state. Set <i>F613=2, 3</i>.
<i>0CR</i>	0005	Arm overcurrent at start-up	<ul style="list-style-type: none"> A main circuit elements is defective. 	<ul style="list-style-type: none"> Make a service call.
* <i>EPH1</i>	0008	Input phase failure	<ul style="list-style-type: none"> A phase failure occurred in the input line of the main circuit. The capacitor in the main circuit lacks capacitance. 	<ul style="list-style-type: none"> Check the main circuit input line for phase failure. Check the capacitor in the main circuit for exhaustion.
* <i>EPHD</i>	0009	Output phase failure	<ul style="list-style-type: none"> A phase failure occurred in the output line of the main circuit. 	<ul style="list-style-type: none"> Check the main circuit output line, motor, etc. for phase failure. Select output phase failure detection parameter <i>F605</i>.
<i>0P1</i>	000A	Overvoltage during acceleration	<ul style="list-style-type: none"> The input voltage fluctuates abnormally. (1) The power supply has a capacity of 200kVA or more. (2) A power factor improvement capacitor is opened or closed. (3) A system using a thyristor is connected to the same power distribution line. A restart signal is input to the rotating motor after a momentary stop, etc. 	<ul style="list-style-type: none"> Insert a suitable input reactor. Use <i>F301</i> (auto-restart) and <i>F302</i> (ride-through control).

* This marking trips can be selected valid or invalid by parameters.

(Continued overleaf)

(Continued)

Error code	Failure code	Problem	Possible causes	Remedies
$\overline{OP2}$	000B	Overvoltage during deceleration	<ul style="list-style-type: none"> The deceleration time dEC is too short. (Regenerative energy is too large.) Overvoltage limit operation $F305$ is set to 1. (Disabled). The input voltage fluctuates abnormally. <ol style="list-style-type: none"> The power supply has a capacity of 200kVA or more. A power factor improvement capacitor is opened and closed. A system using a thyrister is connected to the same power distribution line. 	<ul style="list-style-type: none"> Increase the deceleration time dEC. Set overvoltage limit operation $F305$ to 0, 2, 3. Insert a suitable input reactor.
$\overline{OP3}$	000C	Overvoltage during constant-speed operation	<ul style="list-style-type: none"> The input voltage fluctuates abnormally. <ol style="list-style-type: none"> The power supply has a capacity of 200kVA or more. A power factor improvement capacitor is opened or closed. A system using a thyrister is connected to the same power distribution line. The motor is in a regenerative state because the load causes the motor to run at a frequency higher than the inverter output frequency. 	<ul style="list-style-type: none"> Insert a suitable input reactor. Install an optional dynamic braking module.
$\overline{OL1}$	000D	Inverter overload	<ul style="list-style-type: none"> The acceleration time ACC is too short. The DC braking amount is too large. The V/F setting is improper. A restart signal is input to the rotating motor after a momentary stop, etc. The load is too large. 	<ul style="list-style-type: none"> Increase the acceleration time ACC. Reduce the DC braking amount $F251$ and the DC braking time $F252$. Check the V/F parameter setting. Use $F301$ (auto-restart) and $F302$ (ride-through control). Use an inverter with a larger rating.
$\overline{OL2}$	000E	Motor overload	<ul style="list-style-type: none"> The V/F setting is improper. The motor is locked up. Low-speed operation is performed continuously. An excessive load is applied to the motor during operation. 	<ul style="list-style-type: none"> Check the V/F parameter setting. Check the load (operated machine). Adjust $OL7$ to the overload that the motor can withstand during operation in a low speed range.
$\overline{OL3}$	003E	Main module overload	<ul style="list-style-type: none"> The carrier frequency is high and load current has increased at low speeds (mainly at 15Hz or less). 	<ul style="list-style-type: none"> Raise the operation frequency. Reduce the load. Reduce the carrier frequency. When an operating motor is started up at 0Hz, use the auto-restart function. Set carrier frequency control mode selection $F315$ to 1. (carrier frequency with automatic reduction).
\overline{OLr}	000F	Dynamic braking resistor overload trip	<ul style="list-style-type: none"> The deceleration time is too short. Dynamic braking is too large. 	<ul style="list-style-type: none"> Increase the deceleration time dEC. Increase the capacity of dynamic braking resistor (wattage) and adjust PBR capacity parameter $F303$.
\overline{Ot}	0020	Over-torque trip 1	<ul style="list-style-type: none"> Over-torque reaches to a detection level during operation. 	<ul style="list-style-type: none"> Enable $F615$ (over-torque trip selection). Check system error.
$\overline{OL2}$	0041	Over-torque trip 2	<ul style="list-style-type: none"> Overcurrent stall or torque limit is occurred in $F452$ or more during power running. 	<ul style="list-style-type: none"> Reduce the load. Increase the overcurrent stall level or torque limit level.

* This marking trips can be selected valid or invalid by parameters.

(Continued overleaf)

(Continued)

Error code	Failure code	Problem	Possible causes	Remedies
<i>OH</i>	0010	Overheat	<ul style="list-style-type: none"> The cooling fan does not rotate. The ambient temperature is too high. The vent is blocked up. A heat generating device is installed close to the inverter. 	<ul style="list-style-type: none"> The fan requires replacement if it does not rotate during operation. Restart the operation by resetting the inverter after it has cooled down enough. Secure sufficient space around the inverter. Do not place any heat generating device near the inverter.
<i>OH2</i>	002E	Thermal trip stop command from external device	<ul style="list-style-type: none"> A thermal trip command (input terminal function: <i>46</i> or <i>47</i>) is issued by an external control device. 	<ul style="list-style-type: none"> The motor is overheated, so check whether the current flowing into the motor exceeds the rated current.
<i>E</i>	0011	Emergency stop	<ul style="list-style-type: none"> During automatic operation or remote operation, a stop command is entered from the operation panel or a remote input device. 	<ul style="list-style-type: none"> Reset the inverter. If the emergency stop signal is input, reset after releasing this signal.
<i>EEP1</i>	0012	EEPROM fault 1	<ul style="list-style-type: none"> A data writing error occurs. 	<ul style="list-style-type: none"> Turn off the inverter, then turn it again. If it does not recover from the error, make a service call.
<i>EEP2</i>	0013	EEPROM fault 2	<ul style="list-style-type: none"> Power supply is cut off during <i>UP</i> operation and data writing is aborted. The error occurred when various data was written. 	<ul style="list-style-type: none"> Turn the power off temporarily and turn it back on, and then try <i>UP</i> operation again. Write the data again. Make a service call when it happening frequently.
<i>EEP3</i>	0014	EEPROM fault 3	<ul style="list-style-type: none"> A data reading error occurred. 	<ul style="list-style-type: none"> Turn off the inverter, then turn it again. If it does not recover from the error, make a service call.
<i>Err2</i>	0015	Main unit RAM fault	<ul style="list-style-type: none"> The control RAM is defective. 	<ul style="list-style-type: none"> Make a service call.
<i>Err3</i>	0016	Main unit ROM fault	<ul style="list-style-type: none"> The control ROM is defective. 	<ul style="list-style-type: none"> Make a service call.
<i>Err4</i>	0017	CPU fault 1	<ul style="list-style-type: none"> The control CPU is defective. 	<ul style="list-style-type: none"> Make a service call.
<i>Err5</i>	0018	Remote control error	<ul style="list-style-type: none"> The communication was broken off. 	<ul style="list-style-type: none"> Check the remote control device, cables, etc.
<i>Err7</i>	001A	Current detector fault	<ul style="list-style-type: none"> The current detector is defective. 	<ul style="list-style-type: none"> Make a service call.
<i>Err8</i>	001B	Optional unit fault 1	<ul style="list-style-type: none"> An optional device has failed. (such as a communication device) 	<ul style="list-style-type: none"> Check the connection of optional board.
<i>Err9</i>	001C	Remote keypad disconnection fault	<ul style="list-style-type: none"> After run signal is activated by RUN key of the remote keypad, disconnection is occurred in 10 seconds or more. 	<ul style="list-style-type: none"> In case the remote keypad is disconnected, press STOP key before. This fault is disabled by <i>F73</i> = 1 setting.
* <i>UL</i>	001D	Low-current operation Trip	<ul style="list-style-type: none"> The output current decreased to a low-current detection level during operation. 	<ul style="list-style-type: none"> Enable <i>F610</i> (low-current detection). Check the suitable detection level for the system (<i>F609</i>, <i>F611</i>, <i>F612</i>). Make a service call if the setting is correct.
* <i>UP1</i>	001E	Undervoltage trip (main circuit)	<ul style="list-style-type: none"> The input voltage (in the main circuit) is too low. 	<ul style="list-style-type: none"> Check the input voltage. Enable <i>F627</i> (undervoltage trip selection). To take measures to momentary power failure, set <i>F627</i>=0. Regenerative power ride-through control <i>F302</i> and Auto-restart control selection <i>F301</i>.
<i>EF2</i>	0022	Ground fault trip	<ul style="list-style-type: none"> A ground fault occurs in the output cable or the motor. Overcurrent of dynamic braking resistor 	<ul style="list-style-type: none"> Check the cable and the motor for ground faults. Increase the deceleration time <i>dEL</i>. Set the supply voltage correction <i>F307</i> to 1 or 3.

* This marking trips can be selected valid or invalid by parameters.

(Continued overleaf)

(Continued)

Error code	Failure code	Problem	Possible causes	Remedies
<i>E t n</i>	0028	Auto-tuning error	<ul style="list-style-type: none"> The motor parameter $u L$, $u L u$, $F 4 0 5$, $F 4 1 5$, $F 4 1 7$ are not set correctly. 	<ul style="list-style-type: none"> Set the left column parameters correctly as a motor name plate and make an auto-tuning again.
<i>E t n 1</i>	0054		<ul style="list-style-type: none"> The motor with the capacity of 2 classes or less than the inverter is used. 	<ul style="list-style-type: none"> Set the left column parameters correctly as a motor name plate and make an auto-tuning again.
<i>E t n 2</i>	0055		<ul style="list-style-type: none"> The output cable is too thin. 	<ul style="list-style-type: none"> Then set $F 4 0 0 = 1$, when trip occurs.
<i>E t n 3</i>	0056		<ul style="list-style-type: none"> The inverter is used for loads other than those of three-phase induction motors. 	
			<ul style="list-style-type: none"> The motor is not connected. 	<ul style="list-style-type: none"> Connect the motor. Check whether the secondary magnetic contactor.
			<ul style="list-style-type: none"> The motor is rotating. 	<ul style="list-style-type: none"> Make an auto-tuning again after the rotation of the motor stops.
* <i>S O U t</i>	002F	Step-out (for PM motor drive only)	<ul style="list-style-type: none"> The motor shaft is locked. One output phase is open. An impact load is applied. Using the DC braking function. 	<ul style="list-style-type: none"> Unlock the motor shaft. Check the interconnect cables between the inverter and the motor. Prolong the acceleration / deceleration time. Turn off the Step-out function when using the DC braking function or change the DC braking to Servo lock function.
<i>P r F</i>	003B	Safe torque off error	<ul style="list-style-type: none"> Error of safe torque off circuit 	<ul style="list-style-type: none"> Make a service call.
<i>E t Y P</i>	0029	Inverter type error	<ul style="list-style-type: none"> It may be a breakdown failure. 	<ul style="list-style-type: none"> Make a service call.
<i>E - 1 3</i>	002D	Over speed fault	<ul style="list-style-type: none"> The input voltage fluctuates abnormally. Over speed fault due to the overvoltage limit operation. 	<ul style="list-style-type: none"> Check the input voltage. Install an optional dynamic braking module.
* <i>E - 1 8</i>	0032	Brea in analog signal cable	<ul style="list-style-type: none"> The input signal from VIC is equal to or less than the $F 6 3 3$ setting. 	<ul style="list-style-type: none"> Check the VIC signal cable for breaks. Also, check the input signal value or setting of $F 6 3 3$.
<i>E - 1 9</i>	0033	CPU communications error	<ul style="list-style-type: none"> A communications error occurs between control CPUs. 	<ul style="list-style-type: none"> Make a service call.
<i>E - 2 0</i>	0034	Excessive torque boosted	<ul style="list-style-type: none"> The automatic torque boost parameter $F 4 0 2$ setting is too high. The motor has too small impedance. 	<ul style="list-style-type: none"> Set a lower automatic torque boost parameter $F 4 0 2$ setting. Make an auto-tuning.
<i>E - 2 1</i>	0035	CPU fault 2	<ul style="list-style-type: none"> The control CPU is defective. 	<ul style="list-style-type: none"> Make a service call.
<i>E - 2 3</i>	0037	Optional unit fault 2	<ul style="list-style-type: none"> An optional device is defective. 	<ul style="list-style-type: none"> Make a service call.
<i>E - 2 6</i>	003A	CPU fault 3	<ul style="list-style-type: none"> The control CPU is defective. 	<ul style="list-style-type: none"> Make a service call.
<i>E - 3 2</i>	0040	PTC fault	<ul style="list-style-type: none"> PTC thermal protection is occurred. 	<ul style="list-style-type: none"> Check the PTC in motor.
<i>E - 3 7</i>	0045	Servo lock fault	<ul style="list-style-type: none"> The motor shaft is not locked in servo lock operation. 	<ul style="list-style-type: none"> Reduce the load in servo lock operation.

* This marking trips can be selected valid or invalid by parameters.

[Alarm information] Each message in the table is displayed to give a warning but does not cause the inverter to trip.

Error code	Problem	Possible causes	Remedies
<i>OFF</i>	ST terminal OFF	<ul style="list-style-type: none"> The ST-CC circuit is opened. 	<ul style="list-style-type: none"> Close the ST-CC circuit.
<i>UOFF</i>	Undervoltage in main circuit	<ul style="list-style-type: none"> The supply voltage between R, S and T is under voltage. 	<ul style="list-style-type: none"> Measure the main circuit supply voltage. If the voltage is at a normal level, the inverter requires repairing.
<i>rtry</i>	Retry in process	<ul style="list-style-type: none"> The inverter is in process of retry. A momentary stop occurred. The motor speed is being detected. 	<ul style="list-style-type: none"> The inverter restarts automatically. Be careful of the machine because it may suddenly restart.
<i>Err1</i>	Frequency point setting error alarm	<ul style="list-style-type: none"> The frequency setting signals at points 1 and 2 are set too close to each other. 	<ul style="list-style-type: none"> Set the frequency setting signals at points 1 and 2 apart from each other.
<i>CLR</i>	Clear command acceptable	<ul style="list-style-type: none"> This message is displayed when pressing the STOP key while an error code is displayed. 	<ul style="list-style-type: none"> Press the STOP key again to clear the trip.
<i>EOFF</i>	Emergency stop command acceptable	<ul style="list-style-type: none"> The operation panel is used to stop the operation in automatic control or remote control mode. 	<ul style="list-style-type: none"> Press the STOP key for an emergency stop. To cancel the emergency stop, press any other key.
<i>Hll</i> <i>LG</i>	Setting error alarm / An error code and data are displayed alternately twice each.	<ul style="list-style-type: none"> An error is found in a setting when data is reading or writing. 	<ul style="list-style-type: none"> Check whether the setting is made correctly.
<i>HERd/</i> <i>End</i>	Display of first/last data items	<ul style="list-style-type: none"> The first and last data item in the <i>RUH</i> data group is displayed. 	<ul style="list-style-type: none"> Press MODE key to exit the data group.
<i>db</i>	DC braking	<ul style="list-style-type: none"> DC braking in process 	<ul style="list-style-type: none"> The message goes off in several tens of seconds if no problem occurs. Note)
<i>E1</i> <i>E2</i> <i>E3</i>	Flowing out of excess number of digits	<ul style="list-style-type: none"> The number of digits such as frequencies is more than 4. (The upper digits have a priority.) 	<ul style="list-style-type: none"> Lower the frequency free unit magnification <i>F7G2</i>.
<i>StOP</i>	Momentary power failure deceleration stop prohibition function activated.	<ul style="list-style-type: none"> The slowdown stop prohibition function set with <i>F3G2</i> (momentary power failure ride-through operation) is activated. 	<ul style="list-style-type: none"> To restart operation, reset the inverter or input an operation signal again.
<i>LStP</i>	Auto-stop because of continuous operation at the lower-limit frequency	<ul style="list-style-type: none"> The automatic stop function selected with <i>F255</i> was activated. 	<ul style="list-style-type: none"> This function is cancelled, when frequency reference reaches LL+0.2Hz or operation command is OFF.
<i>init</i>	Parameters in the process of initialization	<ul style="list-style-type: none"> Parameters are being initialized to default values. 	<ul style="list-style-type: none"> Normal if the message disappears after a while (several seconds to several tens of seconds).
<i>R-01</i>	Points setting alarm 1	<ul style="list-style-type: none"> In case of <i>Pt=7</i>, there are same setting value at least two on parameter <i>UL</i>, <i>F190</i>, <i>F192</i>, <i>F194</i>, <i>F196</i>, or <i>F198</i> except 0.0Hz. 	<ul style="list-style-type: none"> Set the points to different values.
<i>R-02</i>	Points setting alarm 2	<ul style="list-style-type: none"> In case of <i>Pt=7</i>, the inclination of <i>Vf</i> is too high. 	<ul style="list-style-type: none"> Set the inclination of <i>Vf</i> to be flat.
<i>R-05</i>	Output frequency upper limit	<ul style="list-style-type: none"> An attempt was made to operate at a frequency higher than 10 times the base frequency (<i>UL</i> or <i>F170</i>). 	<ul style="list-style-type: none"> Operate at a frequency within 10 times the base frequency.
<i>R-17</i>	Operation panel key fault	<ul style="list-style-type: none"> The RUN or STOP key is held down for more than 20 seconds. The RUN or STOP key is faulty. 	<ul style="list-style-type: none"> Check the operation panel.
<i>R-2B</i>	S3 terminal alarm	<ul style="list-style-type: none"> Slide switch SW2 and parameter <i>F147</i> settings are different. 	<ul style="list-style-type: none"> Match the settings of SW2 and <i>F147</i>. Power supply OFF and ON after these settings.
<i>Rtn</i>	Auto-tuning	<ul style="list-style-type: none"> Auto-tuning in process 	<ul style="list-style-type: none"> Normal if it the message disappears after a few seconds.

Note) When the DC braking (DB) function is assigned by using the input terminal function 22 or 23, it is normal if "db" disappears when opening the circuit between the terminal and CC.

(Continued overleaf)

(Continued)

Error code	Problem	Possible causes	Remedies
$R L \emptyset S$	Break in analog signal cable	<ul style="list-style-type: none"> The signal input via VIC is below the analog signal detection level set with $F 6 \bar{3} \bar{3}$ and setting value of $F 6 \bar{4} \bar{4}$ is one or more. 	<ul style="list-style-type: none"> Check the cables for breaks. And check the setting of input signal or setting value of $F 6 \bar{3} \bar{3}$ and $F 6 \bar{4} \bar{4}$.
$F i r E$	In forced operation	<ul style="list-style-type: none"> "$F i r E$" and operation frequency is displayed alternately in operation of forced fire-speed control. 	<ul style="list-style-type: none"> It is normal the alarm is gone out after the forced fire-speed control operation.
$P r R$	STO signal OFF	<ul style="list-style-type: none"> STO terminal is in open-circuit. 	<ul style="list-style-type: none"> Close STO and + SU circuit.
$P R \bar{5} \bar{5} /$ $F R \bar{1} \bar{L}$	Password verification result	<ul style="list-style-type: none"> After the password setting ($F \bar{7} \bar{3} \bar{8}$), the password was input to $F \bar{7} \bar{3} \bar{9}$ (password verification). 	<ul style="list-style-type: none"> If the password is correct, $P R \bar{5} \bar{5}$ is displayed and if it is incorrect, $F R \bar{1} \bar{L}$ is displayed.
$E R \bar{5} \bar{Y} /$ $S \bar{t} \bar{d}$	Switching display of Easy setting mode / Standard setting mode	<ul style="list-style-type: none"> The EASY key was pushed in the standard monitor mode. 	<ul style="list-style-type: none"> When $E R \bar{5} \bar{Y}$ is displayed, setting mode becomes easy setting mode. When $S \bar{t} \bar{d}$ is displayed, it becomes standard setting mode.
$S \bar{E} \bar{L}$	Input requirement of region setting	<ul style="list-style-type: none"> Checking the region setting parameter $S \bar{E} \bar{L}$ was set to $\bar{0}$. 	<ul style="list-style-type: none"> Set a region setting by using setting dial. Refer to section 3.1.
$n \bar{E} r r$	No trip of past trip	<ul style="list-style-type: none"> No new record of past trip, after past trips were clear. 	<ul style="list-style-type: none"> Normal operation.
$n - -$	No detailed information of past trip	<ul style="list-style-type: none"> The detailed information of past trip is read by pushing the center of setting dial during blinking $n \bar{E} r r \Leftrightarrow$ number. 	<ul style="list-style-type: none"> Normal operation. To be returned by pressing MODE key.

[Prealarm display]

\bar{L}	Overcurrent alarm	Same as $\bar{0} \bar{L}$ (overcurrent)
P	Overvoltage alarm	Same as $\bar{0} P$ (overvoltage)
\bar{L}	Overload alarm	Same as $\bar{0} \bar{L} \bar{1}$ and $\bar{0} \bar{L} \bar{2}$ (overload)
H	Overheat alarm	Same as $\bar{0} H$ (overheat)
\bar{L}	Communication alarm	Same as $\bar{E} r r \bar{5}$ (communication fault)

If two or more problems arise simultaneously, one of the following alarms appears and blinks.

$\bar{L} P, P \bar{L}, \bar{L} P \bar{L}$

The blinking alarms $\bar{L}, P, \bar{L}, H, \bar{L}$ are displayed in this order from left to right.

13.2 Restoring the inverter from a trip

Do not reset the inverter when tripped because of a failure or error before eliminating the cause. Resetting the tripped inverter before eliminating the problem causes it to trip again.

The inverter can be restored from a trip by any of the following operations:

- (1) By turning off the power (Keep the inverter off until the LED turns off.)
Note) See inverter trip hold selection $F 5 Q 2$ for details.
- (2) By means of an external signal (Short circuit across RES and CC on control terminal block → Open): The reset function must be assigned to the input terminal block. (function number 8, 9)
- (3) By panel keypad operation
- (4) By inputting a trip clear signal from communication (Refer to communication manual for details.)

To reset the inverter by panel keypad operation, follow these steps.

1. Press the STOP key and make sure that $\bar{L} r$ is displayed.
2. Pressing the STOP key again will reset the inverter if the cause of the trip has already been eliminated.

- ★ When any overload function [$\bar{O} L 1$: inverter overload, $\bar{O} L 2$: motor overload, $\bar{O} L r$: braking resistor overload] is active, the inverter cannot be reset by inputting a reset signal from an external device or by operation panel operation before the virtual cooling time has passed.

Virtual cooling time ... $\bar{O} L 1$: about 30 seconds after the occurrence of a trip

$\bar{O} L 2$: about 120 seconds after a occurrence of a trip

$\bar{O} L r$: about 20 seconds after a occurrence of a trip

- ★ In case of a trip due to overheat ($\bar{O} H$), the inverter checks the temperature within. Wait until the temperature in the inverter falls sufficiently before resetting the inverter.
- ★ The inverter cannot be reset while the emergency stop signal is being input from the terminal.
- ★ The inverter cannot be reset while the pre-alarm is occurred.

[Caution]

Turning the inverter off then turning it on again resets the inverter immediately. You can use this mode of resetting if there is a need to reset the inverter immediately. Note, however, that this operation may damage the system or the motor if it is repeated frequently.

13.3 If the motor does not run while no trip message is displayed ...

If the motor does not run while no trip message is displayed, follow these steps to track down the cause.

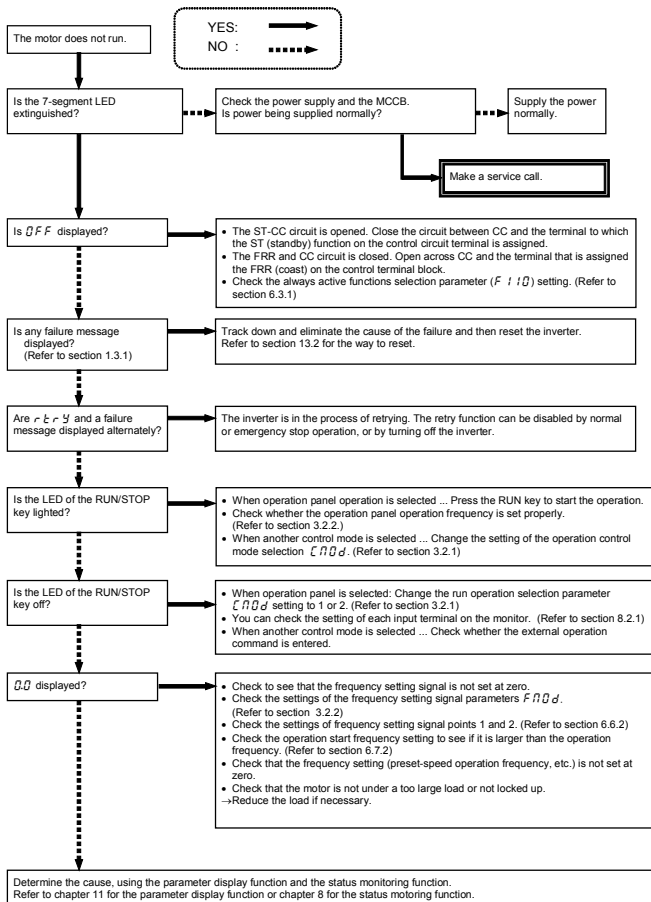

13.4 How to determine the causes of other problems



The following table provides a listing of other problems, their possible causes and remedies.

Problems	Causes and remedies
The motor runs in the wrong direction.	<ul style="list-style-type: none"> • Invert the phases of the output terminals U/T1, V/T2 and W/T3. • Invert the forward/reverse run-signal terminals of the external input device. (Refer to section 7.2.1) • Change the setting of the parameter F_{r-} in the case of panel operation.
The motor runs but its speed does not change normally.	<ul style="list-style-type: none"> • The load is too heavy. Reduce the load. • The soft stall function is activated. Disable the soft stall function. (Refer to section 3.5) • The maximum frequency F_H and the upper limit frequency U_L are set too low. Increase the maximum frequency F_H and the upper limit frequency U_L. • The frequency setting signal is too low. Check the signal set value, circuit, cables, etc. • Check the setting characteristics (point 1 and point 2 settings) of the frequency setting signal parameters. (Refer to section 6.6.2) • If the motor runs at a low speed, check to see that the stall prevention function is activated because the torque boost amount is too large. Adjust the torque boost value (u_b) and the acceleration time (R_{LCL}). (Refer to section 5.13 and 5.4)
The motor does not accelerate or decelerate smoothly.	<ul style="list-style-type: none"> • The acceleration time (R_{LCL}) or the deceleration time (d_{ELC}) is set too short. Increase the acceleration time (R_{LCL}) or the deceleration time (d_{ELC}).
A too large current flows into the motor.	<ul style="list-style-type: none"> • The load is too heavy. Reduce the load. • If the motor runs at a low speed, check whether the torque boost value is too large. (Refer to section 5.13)
The motor runs at a higher or lower speed than the specified one.	<ul style="list-style-type: none"> • The motor has an improper voltage rating. Use a motor with a proper voltage rating. • The motor terminal voltage is too low. Check the setting of the base frequency voltage parameter (u_{L_u}). (Refer to section 5.11) Replace the cable with a cable larger in diameter. • The reduction gear ratio, etc., are not set properly. Adjust the reduction gear ratio, etc. • The output frequency is not set correctly. Check the output frequency range. • Adjust the base frequency. (Refer to section 5.11)
The motor speed fluctuates during operation.	<ul style="list-style-type: none"> • The load is too heavy or too light. Reduce the load fluctuation. • The inverter or motor used does not have a rating large enough to drive the load. Use an inverter or motor with a rating large enough. • Check whether the frequency setting signal changes. • If the V/F control selection parameter P_{L_1} is set at $\bar{3}$, check the vector control setting, operation conditions, etc. (Refer to section 5.12)
Parameter settings cannot be changed.	<ul style="list-style-type: none"> • Change the setting of the parameter setting selection prohibited parameter F_{700} to $\bar{0}$ (enabled) if it is set to $\bar{1}$ to $\bar{4}$ (prohibited). • Set the verification code to F_{733}, if password has entered by the password setting F_{73B}. (Refer to section 6.29.1) • Switch off the logic input terminal, if this terminal is assigned to input terminal menu 200 to 203 (Parameter editing / reading prohibition). • For reasons of safety, some parameters cannot be reprogrammed while the inverter is running. (Refer to section 4.2)

How to cope with parameter setting-related problems

If you forget parameters which have been reset	<ul style="list-style-type: none"> • You can search for all reset parameters and change their settings. * Refer to section 4.3.1 for details.
If you want to return all reset parameters to their respective default settings	<ul style="list-style-type: none"> • You can return all parameters which have been reset to their default settings. * Refer to section 4.3.2 for details.

14. Inspection and maintenance

 Warning	
 Mandatory action	<ul style="list-style-type: none"> • The equipment must be inspected every day. If the equipment is not inspected and maintained, errors and malfunctions may not be discovered which could lead to accidents. • Before inspection, perform the following steps. <ol style="list-style-type: none"> (1) Shut off all input power to the inverter. (2) Wait at least 15 minutes and check to make sure that the charge lamp is no longer lit. (3) Use a tester that can measure DC voltages (400V/800V DC or more), and check that the voltage to the DC main circuits (across PA-PC) does not exceed 45V. <p style="text-align: center;">Performing an inspection without carrying out these steps first could lead to electric shock.</p>

Be sure to inspect the inverter regularly and periodically to prevent it from breaking down because of the environment of use, such as temperature, humidity, dust and vibration, or deterioration of its components with aging.

14.1 Regular inspection

Since electronic parts are susceptible to heat, install the inverter in a cool, well-ventilated and dust-free place. This is essential for increasing the service life.

The purpose of regular inspections is to maintain the correct environment of use and to find any sign of failure or malfunction by comparing current operation data with past operation records.

Subject of inspection	Inspection procedure			Criteria for judgment
	Inspection item	Inspection cycle	Inspection method	
1. Indoor environment	1) Dust, temperature and gas	Occasionally	1) Visual check, check by means of a thermometer, smell check	1) Improve the environment if it is found to be unfavorable. 2) Check for any trace of water condensation. 3) Max. temperature: 60°C
	2) Drop of water or other liquid	Occasionally	2) Visual check	
	3) Room temperature	Occasionally	3) Check by means of a thermometer	
2. Units and components	1) Vibration and noise	Occasionally	Tactile check of the cabinet	If something unusual is found, open the door and check the transformer, reactors, contactors, relays, cooling fan, etc., inside. If necessary, stop the operation.
3. Operation data (output side)	1) Load current	Occasionally	Moving-iron type AC ammeter	To be within the rated current, voltage and temperature. No significant difference from data collected in a normal state.
	2) Voltage (*)	Occasionally	Rectifier type AC voltmeter	
	3) Temperature	Occasionally	Thermometer	

*) The voltage measured may slightly vary from voltmeter to voltmeter. When measuring the voltage, always take readings from the same circuit tester or voltmeter.

■ Check points

1. Something unusual in the installation environment
2. Something unusual in the cooling system
3. Unusual vibration or noise
4. Overheating or discoloration
5. Unusual odor
6. Unusual motor vibration, noise or overheating
7. Adhesion or accumulation of foreign substances (conductive substances)

■ Cautions about cleaning



To clean the inverter, wipe dirt off only its surface with a soft cloth but do not try to remove dirt or stains from any other part. If stubborn stains persist, remove them by wiping gently with a cloth dampened with neutral detergent or ethanol.

Never use any of the chemicals in the table below; the use of any of them may damage or peel the coating away from molded parts (such as plastic covers and units) of the inverter.

Acetone	Ethylene chloride	Tetrachloroethane
Benzen	Ethyl acetate	Trichloroethylene
Chloroform	Glycerin	Xylene

14.2 Periodical inspection

Make a periodical inspection at intervals of 3 or 6 months depending on the operating conditions.

 Warning	
 Mandatory action	<ul style="list-style-type: none"> • Before inspection, perform the following steps. <ol style="list-style-type: none"> (1) Shut off all input power to the inverter. (2) Wait at least 15 minutes and check to make sure that the charge lamp is no longer lit. (3) Use a tester that can measure DC voltages (400V/800V DC or more), and check that the voltage to the DC main circuits (across PA-PC) does not exceed 45V. Performing an inspection without carrying out these steps first could lead to electric shock.
 Prohibited	<ul style="list-style-type: none"> • Never replace any part. This could be a cause of electric shock, fire and bodily injury. To replace parts, call the local sales agency.

■ Check items

1. Check to see if all screwed terminals are tightened firmly. If any screw is found loose, tighten it again with a screwdriver.
2. Check to see if all caulked terminals are fixed properly. Check them visually to see that there is no trace of overheating around any of them.
3. Check all cables and wires for damage. Check them visually.
4. Remove dirt and dust. With a vacuum cleaner, remove dirt and dust. When cleaning, clean the vents and the printed circuit boards. Always keep them clean to prevent an accident due to dirt or dust.
5. If no power is supplied to the inverter for a long time, the performance of its large-capacity electrolytic capacitor declines.

When leaving the inverter unused for a long time, supply it with electricity once every two years, for 5 hours or more each, to recover the performance of the large-capacity electrolytic capacitor. And also check the function of the inverter. It is advisable not to supply the commercial power directly to the inverter but to gradually increase the power supply voltage with a transformer, etc.

6. If the need arises, conduct an insulation test on the main circuit terminal board only, using a 500V insulation tester. Never conduct an insulation test on control terminals other than terminals on the printed circuit board or on control terminals. When testing the motor for insulation performance, separate it from the inverter in advance by disconnecting the cables from the inverter output terminals U/T1, V/T2 and W/T3. When conducting an insulation test on peripheral circuits other than the motor circuit, disconnect all cables from the inverter so that no voltage is applied to the inverter during the test.

(Note) Before an insulation test, always disconnect all cables from the main circuit terminal board and test the inverter separately from other equipment..

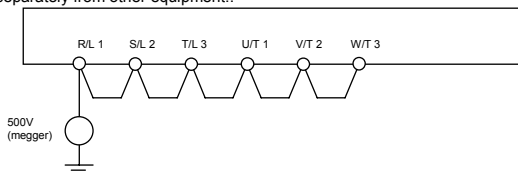

7. Never test the inverter for pressure. A pressure test may cause damage to its components.
8. Voltage and temperature check

Recommended voltmeter : Input side ... Moving-iron type voltmeter (⚡)

Output side ... Rectifier type voltmeter (▶|)

It will be very helpful for detecting a defect if you always measure and record the ambient temperature before, during and after the operation.

■ Replacement of expendable parts

The inverter is composed of a large number of electronic parts including semiconductor devices. The following parts deteriorate with the passage of time because of their composition or physical properties. The use of aged or deteriorated parts leads to degradation in the performance or a breakdown of the inverter. To avoid such trouble, the inverter should be checked periodically.

Note) Generally, the life of a part depends on the ambient temperature and the conditions of use. The life spans listed below are applicable to parts when used under normal environmental conditions.

1) Cooling fan

The fan for cooling heat-generating parts has a service life of about ten years. The fan also needs to be replaced if it makes a noise or vibrates abnormally.

2) Smoothing capacitor

The smoothing aluminum electrolytic capacitor in the main circuit DC section degrades in performance because of ripple currents, etc. It becomes necessary to replace the capacitor after it is used for about 10 years under normal conditions. Since the smoothing capacitor is mounted on a printed circuit board, it must be replaced together with the circuit board.

<Criteria for appearance check>

- Absence of liquid leak
- Safety valve in the depressed position
- Measurement of electrostatic capacitance and insulation resistance

Note: Checking the life alarm function is useful for roughly determining the parts replacement time. To ensure customer safety, you should never replace parts on your own. (It is also possible to monitor the part replacement alarm and output a signal.)

■ Standard replacement cycles of principal parts

As guides, the table below lists part replacement cycles that were estimated based on the assumption that the inverter would be used in a normal use environment under normal conditions (ambient temperature, ventilation conditions, and energizing time). The replacement cycle of each part does not mean its service life but the number of years over which its failure rate does not increase significantly.

Also, make use of the life alarm function.

Part name	Standard replacement cycle Note 1:	Replacement mode and others
Cooling fan	10 years	Replacement with a new one (To be determined after inspection)
Main circuit smoothing aluminum electrolytic capacitor	10 years Note 2	Replacement with a new one (To be determined after inspection)
Relays	-	Whether to replace or not depends on the check results
Aluminum electrolytic capacitor mounted on a printed circuit board	10 years Note 2	Replace with a new circuit board (To be determined after inspection)

Note 1: The replacement cycle is calculated on the assumption that the average ambient temperature over a year is 40°C. The environment must be free of corrosive gases, oil mist and dust.

Note 2: Figures are for when the inverter output current is 80% of the rated current of the inverter.

Note 3: The life of parts varies greatly depending on the operating environment.

14.3 Making a call for servicing

For the Toshiba service network, refer to the back cover of this instruction manual. If defective conditions are encountered, please contact the Toshiba service section in charge via your Toshiba dealer.

When making a call for servicing, please inform us of the contents of the rating label on the right panel of the inverter, the presence or absence of optional devices, etc., in addition to the details of the failure.

14.4 Keeping the inverter in storage

Take the following precautions when keeping the inverter in storage temporarily or for a long period of time.

1. Store the inverter in a well-ventilated place away from heat, damp, dust and metal powder.
2. If no power is supplied to the inverter for a long time, the performance of its large-capacity electrolytic capacitor declines.

When leaving the inverter unused for a long time, supply it with electricity once every two years, for 5 hours or more each, to recover the performance of the large-capacity electrolytic capacitor. And also check the function of the inverter. It is advisable not to supply the commercial power directly to the inverter but to gradually increase the power supply voltage with a transformer, etc.

15. Warranty

Any part of the inverter that proves defective will be repaired and adjusted free of charge under the following conditions:

1. This warranty applies only to the inverter main unit.
2. Any part of the inverter which fails or is damaged under normal use within twelve months from the date of delivery shall be repaired free of charge.
3. For the following kinds of failure or damage, the repair cost shall be borne by the customer even within the warranty period.
 - Failure or damage caused by improper or incorrect use or handling, or unauthorized repair or modification of the inverter
 - Failure or damage caused by the inverter falling or an accident during transportation after the purchase
 - Failure or damage caused by fire, salty water or wind, corrosive gas, earthquake, storm or flood, lightning, abnormal voltage supply, or other natural disasters
 - Failure or damage caused by the use of the inverter for any purpose or application other than the intended one
4. All expenses incurred by Toshiba for on-site services shall be charged to the customer, unless a service contract is signed beforehand between the customer and Toshiba, in which case the service contract has priority over this warranty.

16. Disposal of the inverter



Caution



Mandatory
action

- If you dispose of the inverter, have it done by a specialist in industry waste disposal(*). If you dispose of the inverter by yourself, this can result in explosion of capacitor or produce noxious gases, resulting in injury.
(*) Persons who specialize in the processing of waste and known as "industrial waste product collectors and transporters" or "industrial waste disposal persons." If the collection, transport and disposal of industrial waste is done by someone who is not licensed for that job, it is a punishable violation of the law. (Laws in regard to cleaning and processing of waste materials)

For safety's sake, do not dispose of the disused inverter yourself but ask an industrial waste disposal agent.

Disposing of the inverter improperly could cause its capacitor to explode and emit toxic gas, causing injury to persons.

TOSHIBA

TOSHIBA INDUSTRIAL PRODUCTS SALES CORPORATION

International Operations
9-11, Nihonbashi-honcho 4-chome,
Chuo-ku, Tokyo 103-0023, Japan
TEL : +81-(0)3-5644-5509
FAX : +81-(0)3-5644-5519

TOSHIBA INTERNATIONAL CORPORATION

13131 West Little York RD., Houston,
TX 77041, U.S.A.
TEL : +1-713-466-0277
FAX : +1-713-466-8773

TOSHIBA ASIA PACIFIC PTE., LTD

152 Beach Rd., #16-00 Gateway East,
Singapore 189721
TEL : +65-6297-0990
FAX : +65-6297-5510

TOSHIBA CHINA CO., LTD

HSBC Tower, 1000 Lujiazui Ring Road,
Pudong New Area, Shanghai
200120, The People's Republic of China
TEL : +86-(0)21-6841-5666
FAX : +86-(0)21-6841-1161

TOSHIBA INTERNATIONAL CORPORATION PTY., LTD

2 Morton Street Parramatta, NSW2150, Australia
TEL : +61-(0)2-9763-6600
FAX : +61-(0)2-9890-7542

TOSHIBA INFORMATION, INDUSTRIAL AND POWER SYSTEMS TAIWAN CORP.

6F, No.66, Sec1 Shin Sheng N.RD, Taipei, Taiwan
TEL : +886-(0)2-2581-3639
FAX : +886-(0)2-2581-3631



S1A33394REV00

- For further information, please contact your nearest Toshiba Representative or International Operations-Producer Goods.
- The data given in this manual are subject to change without notice.