

Expansion IO Card Option 1

ETB003Z Instruction manual

NOTE



1. Make sure that this instruction manual is delivered to the end user of the expansion IO card option.
2. Read this manual before installing or operating the inverter unit, and store it in a safe place for reference.

* The data given in this manual are subject to change without notice.

Safety precautions

On the inverter and in its instruction manual, important information is contained for preventing injuries to users and damages to assets and for proper use of the device. Read the instruction manual attached to VF-AS1/PS1 along with this instruction manual for completely understanding the safety precautions and adhere to the contents of these manuals.





Explanation of markings

Marking	Meaning of marking
 Danger	Indicates that errors in operation may lead to death or serious injury.
 Warning	Indicates that errors in operation may lead to injury (*1) to people or that these errors may cause damage to physical property. (*2)





(*1) Such things as injury, burns or shock that will not require hospitalization or long periods of outpatient treatment.

(*2) Physical property damage refers to wide-ranging damage to assets and materials.



Meanings of symbols

Marking	Meaning of marking
	Indicates prohibition (Don't do it). What is prohibited will be described in or near the symbol in either text or picture form.
	Indicates something mandatory (must be done). What is mandatory will be described in or near the symbol in either text or picture form.
	Indicates danger. What is dangerous will be described in or near the symbol in either text or picture form.
	Indicates warning. What the warning should be applied to will be described in or near the symbol in either text or picture form.



General Operation

 Danger	
 Disassembly prohibited	<p>Never disassemble, modify or repair. Doing so could result in electric shock, fire and injury. For repairs, call your sales agency.</p>
 Prohibited	<p>Do not attach this option to any inverter other than the VF-AS1/PS1. Doing so could result in electric shock or fire. When the inverter is energized, never detach the this option from the VF-AS1/PS1. Doing so could result in electric shock. Don't place or insert any kind of object into the ETB003Z (electrical wire cuttings, rods, wires). Doing so could result in electric shock or fire. Do not allow water or any other fluid to come in contact with the ETB003Z. Doing so could result in electric shock or fire.</p>
 Mandatory	<p>Turn off the VF-AS1/PS1 when installing and wiring this option. If the inverter begins to emit smoke or an unusual odor, or unusual sounds, immediately turn power off. If the equipment is continued in operation in such a state, the result may be fire. Call your local sales agency for repairs.</p>



Transportation & installation

 Danger	
 Prohibited	<p>Do not operate the inverter if it is damaged or any component is missing. Doing so could result in electric shock or fire. Call your local sales agency for repairs. Do not place any inflammable substances near the VF-AS1/PS1 Inverter. If an accident occurs in which flame is emitted, this could lead to fire. Do not install in any location where the inverter could come into contact with water or other fluids. Doing so could result in electric shock or fire. When installing this option, be careful not to touch the leads from parts on the reverse side of its circuit board. Doing so could result in injury.</p>
 Mandatory	<p>Operate under the environmental conditions prescribed in the instruction manual. Operations under any other conditions may result in malfunction.</p>



Wiring

 Danger	
 Mandatory	<p>Shut off power when installing and wiring this option.</p> <p>Wait at least 15 minutes and check to make sure that the charge lamp (VF-AS1/PS1) is no longer lit.</p> <p>Tighten the screws on the terminal block to the specified torque (Refer to Section 2.2). If the screws are not tightened to the specified torque, it may lead to fire.</p> <p>Electrical construction work must be done by a qualified expert.</p> <p>Installation or connection of input power by someone who does not have that expert knowledge may result in fire or electric shock.</p>

Operations

 Danger	
 Prohibited	<p>Do not touch switches when the hands are wet and do not try to clean the inverter with a damp cloth.</p> <p>Doing so could result in electric shock.</p> <p>Do not pull on any cable itself.</p> <p>Doing so could result in damage or malfunction.</p>

Disposal

 Warning	
 Mandatory	<p>For safety's sake, do not dispose of the disused inverter yourself but ask an industrial waste disposal agent (*).</p> <p>If the collection, transport and disposal of industrial waste is done by someone who is not licensed for that job, it is a punishable violation of the law. (Laws in regard to cleaning and processing of waste materials)</p> <p>(*) Persons who specialize in the processing of waste and known as "industrial waste product collectors and transporters" or "industrial waste disposal persons."</p>

Notes on use

Notes	
	<p>Do not install the inverter where the temperature or the humidity will change rapidly.</p> <p>Keep a distance of 20cm or more between the inverter's power cable and the data transmission cable.</p> <p>Or the inverter might malfunction because of noise.</p> <p>Insert a magnetic contactor or similar device between the inverter and the power supply to ensure that power is turned off if an emergency stop command is entered through the network.</p>

Introduction

Thank you for purchasing a “Expansion IO card option 1” for industrial inverter TOSVERT VF-AS1/PS1 inverter.

By the use of this option, the expansion of input/output terminal is possible. This instruction manual describes connecting method and usage of the “Expansion IO card option”. Read this manual carefully before using the unit.

Keep this manual near at hand of the operator who uses the “Expansion IO card option” for future reference in the maintenance and inspection.

■ Type of expansion IO option card

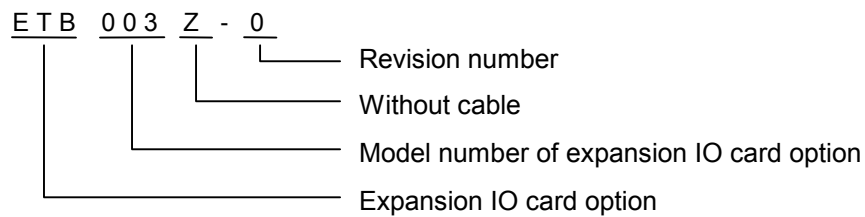

■ Confirmation on accessories

Following accessory parts are included in the expansion IO card option.

Upon unpacking, confirm on the following parts.

Expansion IO card option unit

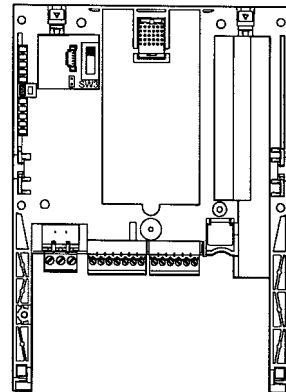

(1) Instruction manual of expansion IO card option (this manual)

E6581339(English)

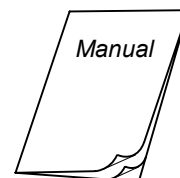

Contents

- 1. Name and function of each section 6
 - 1.1 Appearance6
 - 1.2 Name of each section (terminal)6
- 2. Installing the IO card option in the VF-AS1/PS1 7
 - 2.1 Connection to the inverter.....7
 - 2.2 Wiring8
- 3. Functional description 10
 - 3.1 Multi-function output terminal10
 - 3.2 Multi-function input terminal.....11
 - 3.3 -10V power supply11
 - 3.4 External thermal trip input (TH1+, TH1-)12
- 4. External diagram 13
- 5. Specification..... 14
- 6. Warranty 15

1. Name and function of each section

Following figure shows appearance and name of each section of the expansion IO card option.

1.1 Appearance

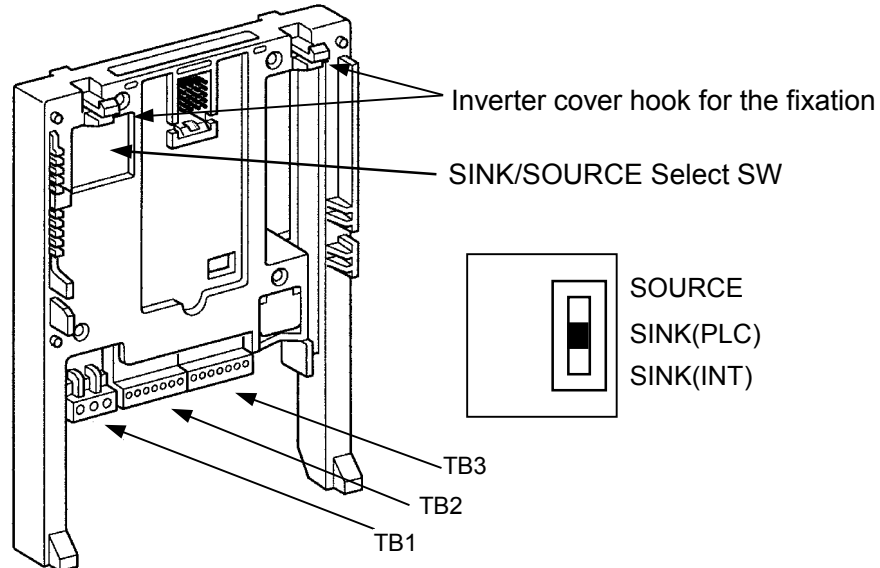

1.2 Name of each section (terminal)

T B 1	R1A	Programmable relay output 1
	R1B	Programmable relay output 1
	R1C	Programmable relay output 1

T B 2	N10	Analog input setting power output -10V
	P24/PLC	Common terminal of extension terminal input
	LI1	Extension terminal input LI1
	LI2	Extension terminal input LI2
	LI3	Extension terminal input LI3
	LI4	Extension terminal input LI4
	CC	Digital signal equipotential (0V)

T B 3	TH1+	PTC input terminal (+)
	TH1-	PTC input terminal (-)
	OUT3	Extension terminal input LI6
	OUT4	Extension terminal input LI7
	NO1	Output 3 and 4 common terminal
	CC	Digital signal equipotential (0V)

2. Installing the IO card option in the VF-AS1/PS1

2.1 Connection to the inverter

Install the IO card option to the VF-AS1/PS1 as follows:

- (1) Turn off input power of VF-AS1/PS1 and wait for at least 15 minutes and then check that the CHARGE lamp on VF-AS1/PS1 is no longer lit.
- (2) Securing the option to the inverter
 - a) Insert a flat-blade screwdriver in each of the two holes at the upper part of the front panel, release the panel mounting tab by pushing the screwdriver down, and remove the front panel cover.
 - b) Install the option in the inverter by fitting the tabs on the lower side of the option into the slots at the lower part of the inverter front panel.
 - c) Make sure the option is securely attached to the inverter. Then, check whether the plastic bosses on the inverter case have fitted in the holes at the upper and lower parts of the option.
 - d) Insert the tabs at the lower part of the front cover into the slots at the lower part of the inverter to attach the front cover to the inverter.
 - e) Stuck the enclosed "LED name label" on the option LED display part of a front cover.

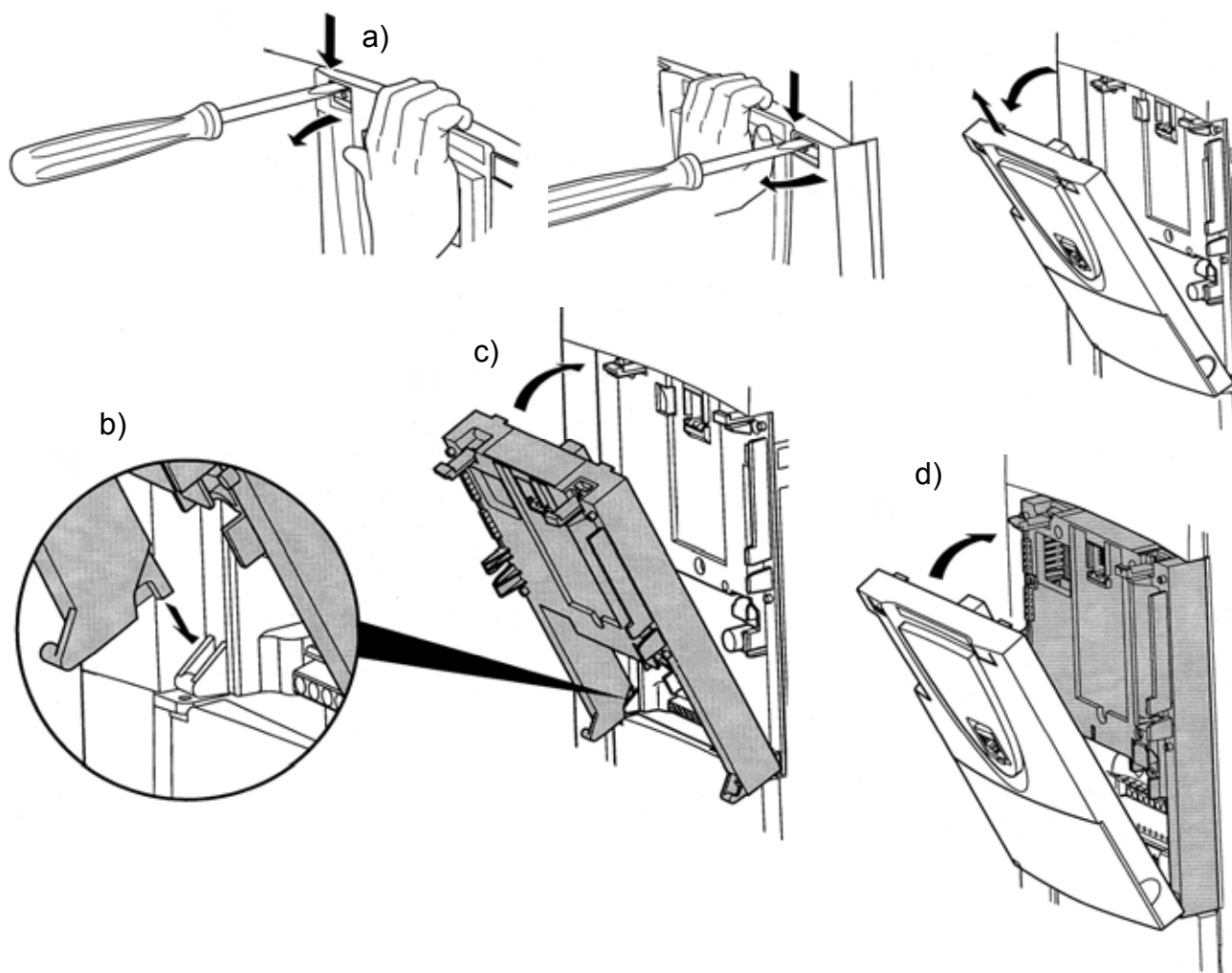

2.2 Wiring

When conducting wiring, follow the instructions below.

- Use shield wire for control signal line and ground the unit with shield wire.
(Use twisted pair shield cable for wiring of the analog monitor output.)
- Applicable wire size..... TB1: 0.2 to 2.5 mm²
TB2, TB3: 0.2 to 1.5mm²
- The wire length of peel off the end..... TB1: About 5mm
TB2, TB3: About 7mm
- Using screwdriver TB1: The blade tip has 0.6mm thickness
and 3.5mm width.
TB2, TB3: The blade tip has 0.4mm thickness
and 2.5mm width.
- Tightening torque of the terminal block..... TB1: 0.5 to 0.6 N·m
TB2, TB3: 0.22 to 0.25 N·m
- Never bind the signal line and main circuit connection wire together.

■ < Input/output terminal interface >

Terminal symbol	Function	Electrical specification	Internal circuit
R1A R1B R1C	Relay contact point output	Configuration of 1C contact point 250Vac - 2A (cos =1) 250Vac - 1A (cos =0.4) 30Vdc - 1A	
LI1 LI2 LI3 LI4	Contact point input Changeover of sink or source	No voltage contact input 24Vdc - 5mA Sink input (common voltage 24V) ON : less than 10Vdc OFF : 16Vdc or more Source input ON : 11Vdc or more OFF : less than 5Vdc Note: <u>Even when an external power supply is used (in sink logic mode i.e. when SINK(PLC) is selected), connect the reference potential-side (0V side) cable from the power supply to the CC terminal.</u> Lan current signal. Chose low current contacts to avoid poor attaching.	<p>SINK Logic (SW=SINK(INT))</p> <p>SINK Logic (SW=SINK(PLC))</p> <p>SOURCE Logic (SW=SOURCE)</p>
PLC/ P24	24V power supply Common terminal for external power supply	24Vdc power output (when SW1 is in any position other than PLC) 24V internal output terminal 24Vdc - 60mA max If SW1 is turned to the PLC position, this terminal can be used as a common terminal when an external power supply is used.	
TH1+ TH1-	Thermal trip input	The resistance between TH1+ and TH1- Tripping value: about under 70 ohm or about over 2.5k ohm Reset value: about 1.6k ohm	
N10	-10V power supply	DC-10V - 10mA	
OUT3 OUT4 NO1	Multifunction programmable open collector output.	Open collector output Drive current External power supply used: 50mA Internal power supply used: 20mA Drive voltage 12V min - 30V max Isolated other circuit.	
CC	Common to input/output	Digital signal equipotential (0V) erminal for the control circuit	

3. Functional description

In this section, functions added by the installation of this expansion IO card option, on top of the standard inverter functions, are described.

* If the software version of inverter is less than V104, when OUT3 or OUT4 terminals is set as negative logic, it may output a flash pulse at inverter reset.

3.1 Multi-function output terminal

Two output terminals and one relay output can be added. Function is similar to that of the output terminals of the inverter, so refer to the inverter instruction manual.

■ Parameter

Title	Function	Adjustment range	Default setting
<i>F 133</i>	Output terminal function selection 4 (OUT3)	0 - 255	254 (Always OFF)
<i>F 134</i>	Output terminal function selection 5 (OUT4)	0 - 255	254 (Always OFF)
<i>F 135</i>	Output terminal function selection 6 (R1)	0 - 255	254 (Always OFF)

■ Monitor

Refer to the description on status monitor mode of inverter's instruction manual.

The output terminal status can be monitored by the output terminal status parameter (*F E 0 7*), and the parameter can be monitor by the serial communication.

F E 0 7

bit No.	15	14	13	12	11	10	9	8	7	6	5	4	3	2	1	0
Symbol	---	---	---	---	---	---	---	R2	OUT 6	OUT 5	R1	OUT 4	OUT 3	FL	OUT 2	OUT 1

Note: The OUT5, OUT6 and R2 are the terminal function of the expansion IO card option 2.

3.2 Multi-function input terminal

Four output terminals can be added. Function is similar to that of the input terminals of the inverter, so refer to the inverter instruction manual.

■ Parameter

Title	Function	Adjustment range	Default setting
<i>F 119</i>	Input terminal selection 9 (LI1)	0 - 135	0
<i>F 120</i>	Input terminal selection 10 (LI2)	0 - 135	0
<i>F 121</i>	Input terminal selection 11 (LI3)	0 - 135	0
<i>F 122</i>	Input terminal selection 12 (LI4)	0 - 135	0
<i>F 144*</i>	Input terminal 5~12 response time selection	2 - 200ms	8

* VF-PS1 does not have this parameter.

■ Monitor

Refer to the description on status monitor mode of inverter's instruction manual.

The input terminal status can be monitored by the input terminal status parameter (*F E 0 5*), and the parameter can be monitor by the serial communication.

F E 0 5

bit No.	15	14	13	12	11	10	9	8	7	6	5	4	3	2	1	0
Symbol	LI8	LI7	LI6	LI5	LI4	LI3	LI2	LI1	S4	S3	S2	S1	RES	ST	R	F

Note: The LI5 ~ LI8 are the terminal function of the expansion IO card option 2.

3.3 -10V power supply

The frequency command can be input from RX terminal with pulse and negative voltage using N10(-10V) and PP(+10V) power.

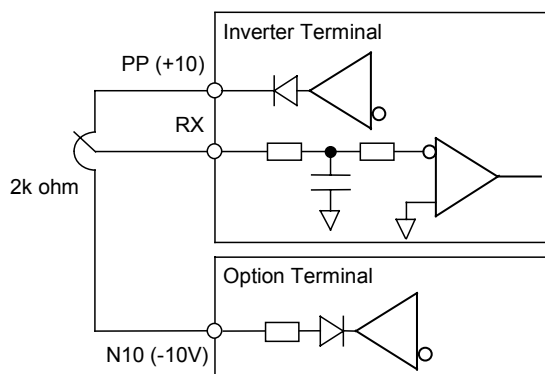

Potentiometer

Center position: 0V command

Pulse side position: +10V command

Negative side position: -10V command

The recommended wiring cable length is less than 1.5m with shielded cable.

3.4 External thermal trip input (TH1+, TH1-)

By connecting the thermistor to TH1+ and TH1- terminal, when the thermistor value is unusual, the inverter can be trip.

The resistor value between TH1+ and TH1-	Detect condition	Movement
about under 70 ohm	Thermistor short broken detection	<i>OH2</i> trip
about 70 - about 2.5k ohm	Normal value	
about 1.6k ohm	Thermistor fault reset	
about 3k ohm	Thermistor fault detection	<i>OH2</i> trip

■ Parameter

Title	Function	Adjustment range	Default setting
<i>F637</i>	PTC thermal selection	0: Deselect 1: Select	0

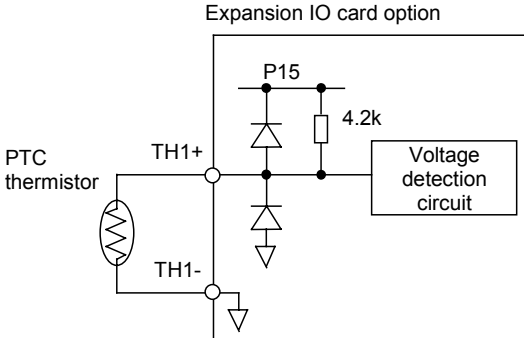

4. External diagram

Do not forget to reserve the space for the options at time of installation.

■ External diagram of option (unit: mm)

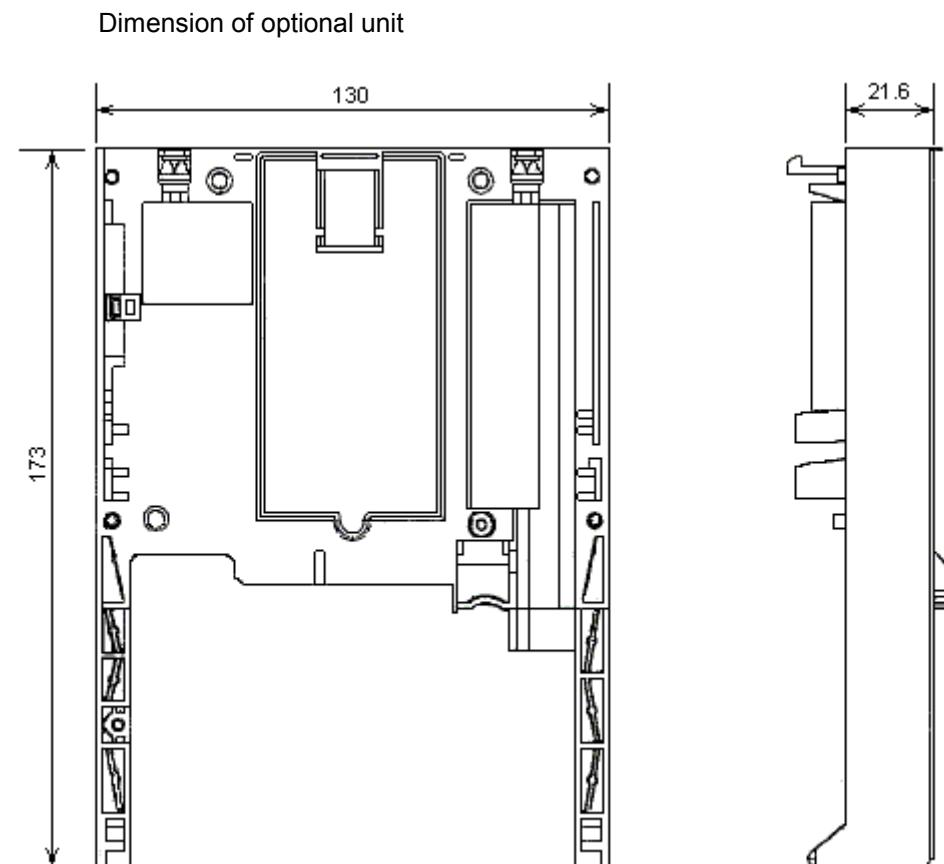

The control panel depth increases about 21.6mm when the option is installed. Secure the front space from the inverter control panel fully. The space which is necessary for the option installation varies in the inverter capacity rate. Please refer to the inverter instruction manual.

5. Specification

<Environment Specification>

Item	Specification
Use Environment	Indoor, less than 3,000 m from the sea level. No direct sunlight, corrosive or explosive gas, steam, cutting dusts or dusts, grinding solution, and grinding oil.
Ambient Temperature	-10 to +60
Storage Temperature	-25 to +65
Relative Humidity	20 to 93 % (No condensation)
Vibration	5.9m/s ² (0.6G) or less (from 10Hz to 55Hz)

< Control specification >

Function	Specification
Relay contact output Multi-function programmable output	1 circuit for output of 1C contact point 250Vac - 2A (cos ϕ =1) 250Vac - 1A (cos ϕ =0.4) 30Vdc - 1A
Contact point input (Changeover of sink / source) Multi-function programmable input	4 contact inputs Sink input (24V common voltage) ON : less than 10Vdc OFF : 16Vdc or more Source input ON : 11Vdc or more OFF : less than 5Vdc
24V power supply	DC24V - 60mA
External thermal trip input	1 circuit. The detection level is below. Tripping value : about under 70 ohm, or about over 2.5k ohm Reset value : about 1.6k ohm
-10V power supply	DC-10V - 10mA
Open collector output Multi-function programmable output	2 circuit Current : 50mA max with external power supply 20mA max with internal power supply Voltage : min. 12V, max 30V

6. Warranty

TOSHIBA provides warranty with the product under the following conditions.

1. If and when a trouble occurs on the option unit properly installed and handled within one year of delivery, and if the trouble is clearly attributable to defects inherent in our design and manufacture, the product will be repaired free of charge.
2. The warranty covers only the delivered option unit.
3. Even in the term of the warranty, repair/adjustment service will be charged for the following cases.
 - 1) Fault or damage resulting from misuse, unauthorized modification or repair.
 - 2) Fault or damage resulting from falling down of the product or traffic accident during transportation.
 - 3) Fault or damage originating from fire, salt water/salty breezes, some kind of gas, earthquake, storm or flood, lightning, abnormal supply voltage, other natural disasters.
 - 4) Fault or damage caused by improper use of this option unit as it is used for a purpose out of its original function.
4. If there is another special warranty contracted for this option unit, the special warranty has priority over this warranty.